

# CUPLA

General Catalog



# CUPLA enables flexible and fast connections in various fluid lines.

Nitto Kohki's unique technologies and dedicated research have been proven by numerous patents, which led to the development of 25000 different CUPLA variations.



**CUPLA**  
Quick Connect Couplings

- Applications diversify from general household to high-tech industries such as in oceanic and space development.
- Numerous sizes are available for various needs.
- Wide varieties of body materials such as steel, brass, plastic, aluminum or stainless steel are available.

### Quick Connect Couplings

Nitto Kohki's quick connect couplings, "CUPLA" enables speedy connections/disconnections of various pipings, such as air, water, oil and gas.

They are active in various industrial fields, thanks to the experience in development of 25000 different variations.

Wide varieties of body materials such as steel, brass, aluminum, stainless steel and plastic are available to match every customer's needs.

<i>For easy replacements</i>	Replacements of pneumatic/hydraulic tools, pneumatic/hydraulic cylinders, mold attachments, etc.
<i>For temporary installation in test line</i>	Vacuum tests, pressure durability tests, leakage tests, running tests, etc.
<i>For filling</i>	For filling up various industrial gases, including inert gases, nitrogen, LPG, carbon dioxide, oxygen, fuel gas, etc.
<i>For maintenance services</i>	For computer cooling system, hydraulic cylinders in die-casting machines.
<i>As joints</i>	Applications other than fluid transfer covering connections for holding works while anchored or carried around.

A profusion of patented technology crystallized in global users recognition of high quality.

### ISO 9001 and ISO 14001 Certification Award

"CUPLA" quick connect couplings are produced as the crystallization of high-grade know-how nurtured in the fields of fluid engineering and materials engineering, and top level precision machining technology. Having assessed Nitto Kohki consistent quality assurance and control system ranging from design and development through procurement of material, manufacture, assembly, and shipping, the Japan Quality Assurance Organization, authority for inspection and registration, awarded us "ISO 9001", international standard for quality management systems, and "ISO 14001", international standard for environment management systems intended to perform global environment preservation and pollution control. High reliability built on unparalleled "high quality" and accumulated history of "productivity" for stable supply. CUPLA is receiving overwhelming support from many users spread all over the world as the top brand for fluid energy transmission and control.



**CUPLA**

# CUPLA enables flexible and fast connections in various fluid lines.

## CONTENTS

### Table of Contents (Preface)

Environmental activities	1
Contents	2
New product	3
Nitto Kohki's environmentally-friendly Manufacturing	4
Select Appropriate CUPLA for the Job	5
Glossary	6
Guide for Selecting "NITTO KOHKI" Standard CUPLA	7
Semi-standard CUPLA Series and CUPLA Accessories	18
Special Made-to-Order CUPLA	19
HI CUPLA Series Interchangeability	21

### Table of Contents (End)

Seal Material Selection Table for Reference	171
Body Material Selection Table	174
Unit Conversion Tables	175
CUPLA Inquiry Form	176
Taper Pipe Threads	178
Production Facilities That Assure Our Product Quality	179
From Development to Production, Management and Marketing of "CUPLA"	180
Nitto Kohki's Laborsaving Products	181
Safety Guide	182
Maintenance of CUPLA	188

### Search CUPLA by fluid

- For Low Pressure (Air)
- For Low Pressure (Water)
- For Oxygen and Fuel Gas
- For Medium Pressure/Low Pressure
- For High Pressure
- For Multi-Port Connection (Manual/Automatic)
- For High Purity Chemicals
- For Inert Gas and Vacuum
- For Paint
- For Food

The color symbols on the left of each product name indicates the main applicable fluid. Also see page 7 to 17 for reference.



### Nitto Kohki's Official YouTube channel

Watch our products in action. We have various products from Quick Connect Couplings "CUPLA" to Power Tools & Machine Tools, "delvo" Electric Screwdrivers, Linear-motor-driven Free Piston Pumps and also Door Closers.



[www.youtube.com/c/NittoKohkiGLOBAL](http://www.youtube.com/c/NittoKohkiGLOBAL)

### ⚠ Beware of imitations

Recently on the market, there have appeared similar products that invite misidentification or confusion with Nitto Kohki couplings, or such products that claim to have compatible mating parts. Nitto Kohki cannot accept responsibility for any accident that may result by mixed use with a coupling of another brand that seems connectable to a Nitto Kohki coupling. CUPLA is produced with their own unique tolerances and precision under strict quality control, and are not interchangeable with other couplings that are not under such tolerances. Therefore, connection to other brand of coupling may end up with abrupt breakdown or personal injury. Please be sure to check for our marks below, which are always inscribed on CUPLA products, when you order and purchase.



### Standard CUPLA Series

● MICRO CUPLA Series	23
● SMALL CUPLA	27
● COMPACT ZEROSPILL CUPLA	29
● COMPACT CUPLA	31
● CUBE CUPLA	33
● SUPER CUPLA	37
● HI CUPLA	39
● HI CUPLA BL	41
● HI CUPLA 200	43
● HI CUPLA for Connection to Braided Hoses	45
● NUT CUPLA	45
● NUT CUPLA 200	45
● ROTARY NUT CUPLA	45
● LOCK CUPLA 200	47
● HI CUPLA Two Way Type	48
● FULL BLOW CUPLA	49
● PURGE HI CUPLA PVR Type	51
● PURGE HI CUPLA	53
● PURGE LINE CUPLA	54
● ROTARY LINE CUPLA (RT Type, RE Type)	55
● LINE CUPLA (200T Type, 200L Type, 200S Type)	57
● ROTARY FULL BLOW LINE CUPLA	59
● HI CUPLA ACE	61
● ROTARY PLUG	63
● TWIST PLUG	64
● PURGE PLUG	65
● ANTI-VIBRATION PLUG HOSE	66
● DUSTER CUPLA	67
● NK CUPLA HOSE Series	68
● MINI CUPLA	69
● LINE CUPLA MINI	70
● MINI CUPLA SUPER	71
● MOLD CUPLA Series	73
● LEVER LOCK CUPLA (Metal Body, Plastic Body)	77
● TSP CUPLA Series	81
● SP CUPLA Type A	85
● HOT WATER CUPLA HW Type	87
● ZEROSPILL CUPLA	89
● HSP CUPLA	91
● HYPER HSP CUPLA	95
● 210 CUPLA	97
● HSU CUPLA	99
● S210 CUPLA	101
● 280 CUPLA	103
● 350 CUPLA	105
● FLATFACE CUPLA F35	107
● FLATFACE CUPLA FF	109
● 450B CUPLA	111
● 700R CUPLA	112
● MULTI CUPLA Series	113
● SEMICON CUPLA Series	143
● SP-V CUPLA Type A	149
● PCV PIPE CUPLA	151
● PAINT CUPLA	153
● HYGIENIC CUPLA	155

### Semi-Standard CUPLA Series

CUPLA with Single Lock, CUPLA with Safety Lock	157
HSP-DC CUPLA	158
HI FLOW CUPLA	159
HI FLOW CUPLA BI Type	160
SP CUPLA Type A PV Type	161
TSP-HP CUPLA for High Pressure	162
PLASTIC CUPLA BC Type	162

### Accessories

DIP MOLD DUST CAP	163
SAFETY CAP	163
DUST CAP	164
SLEEVE COVER	164
PROTECTION COVER	164
SLEEVE STOPPER	165
ACCESSORIES FOR O-RING MAINTENANCE	165
RESIDUAL PRESSURE RELEASE JIG	166
CUPLA ADAPTER for Braided Hose Connection	166
FLOW MONITOR	NEW 167
FLOW METER	168
PURGE ADAPTER	169
CUPLA CONNECTING JIG	170



# New product

## NEW

**The flow of cooling water can be checked at a glance.**

For checking the water flow of mold cooling water pipes

### FLOW MONITOR Replaceable Flow Vane type

- Fluid flow from low flow rate (2 L/min) water pipes can be visually checked with the rotating two-colored impeller.
- Flow Vane ASSY can be replaced without removing it from the piping.
- The stopper prevents unintended removal of the plastic parts.
- Installation and replacement is easy since the screw part of the T2 side rotates freely to the left and right.



Check the flow with the rotating two-colored impeller.

Can be replaced when dirty.

Remove

Replace

Flow Vane ASSY  
(Plastic part)

Inner sleeve

Stopper

T2  
(Female thread)

T1  
(Female thread)

See page 167 for details.

# Popular

**Newly designed in colorful 5 colors.**

Quick connect couplings for air / water piping

### CUBE CUPLA

- An effective outer appearance.
- Prevent piping mistakes by color indication.

Select from All five colors

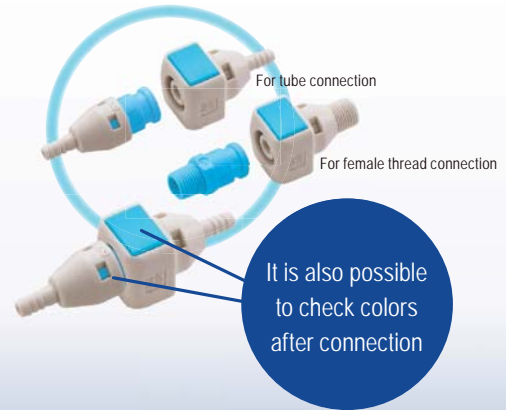

Yellow

Blue

Ivory

Green

Pink

L type plug series added

Small size

Light weight

Push-to-connect operation

Push button easy disconnection



For tube connection

See page 33 to 36 for details.



# Nitto Kohki's environmentally-friendly Manufacturing

The coexistence of mankind and nature. Each company is now asked for a global level environmental conservation and improvement as important themes. As a part of the environmental improvement activities, we are offering various products such as "couplings", "machines and tools", "screwdrivers", "air compressors and vacuum pumps", and "door closers" as green procurement products.

## "CUPLA" active in the widespread field of the manufacturing industry.



## Coupling for fuel cell vehicles.

### HHV CUPLA

CUPLA for fueling high pressure hydrogen

Fuel cell vehicles are one of the remarkable environmental conservation solutions. In order to respond quickly to environmental problems, Nitto Kohki has developed the first coupler in Japan to supply and fill its fuel source, high-pressure pure hydrogen.

HHV CUPLA  
70 MPa

## Nitto Kohki's environmentally-friendly Manufacturing

### Green Procurement

Nitto Kohki has made every effort in developing "Environmental Improvement Plans" through the implementation of ISO14001, to execute environmentally conscious business activities on a company-wide basis. As a part of our ongoing commitment to the environment, we are also committed to reduce and/or exclude restricted chemical substances from our products as designated by RoHS directives, laws and regulations of chemical substances. Some products may not be compliant, so please check our corporate website for the latest status.

All couplings except for the following products have been switched to green procurement compliant products.

- LEVER LOCK CUPLA
  - All CUPLA products with Tube Fitter
  - CUPLA CONNECTING JIG
- } Non compliant

Please visit our website for applicable products.

[www.nitto-kohki.co.jp/e/](http://www.nitto-kohki.co.jp/e/)



## CUPLA

### Products using regulated substances and the countermeasures taken

Products (Standard CUPLA)	Major countermeasures
Products using brass material	Low cadmium contained material used (RoHS directive compliant material)
Zinc chrome plated couplings	Hexavalent chromium-free plated (Such as nickel plated)

Note: Color of plating

The color of the zinc chrome plating is yellow, while nickel plating is silver. Some products may look different in appearance when changed.

# Select Appropriate CUPLA for the Job

Nitto Kohki has the wide range of CUPLA products covering almost every application and feature you need. In order to select an appropriate CUPLA for your job, you need to realize the following specifications.

## Specifications to Be Checked When Selecting CUPLA

<b>Fluid and the Temperature</b>	Select CUPLA with body and seal materials that suit the fluid and its temperature.	There are different body and seal materials to suit different fluids. For example, we recommend steel HI CUPLA for air, and brass or stainless steel for water. Please refer to Body Material Selection Table and Seal Material Selection Table at the end of this catalog for details about the correspondence between fluids and materials.
<b>Fluid Pressure</b>	Select CUPLA suitable for the actual maximum fluid pressure.	Fluid pressure is also a key to CUPLA selection. Each series of hydraulic CUPLA have different structures to cope with each pressure resistance ranges up to 68.6 MPa (700 kgf/cm <sup>2</sup> ).
<b>Automatic Shut-off Valve</b>	Select CUPLA with a valve structure that suits the piping application.	Valve combinations are two-way shut-off, one-way shut-off, or straight through types. Choose carefully. Unless it is a two-way shut-off type, the internal fluid will flow out when it is disconnected.
<b>Operating Environment</b>	Select CUPLA with design and materials that suit each operating environment.	In choosing the type of CUPLA, body material and seal material, consider the temperature range, and/or corrosive atmosphere in the operating environment.
<b>Size and Type of End Configurations</b>	Finally and critically specify the size and type of end configurations.	Having checked the type and materials for CUPLA, now specify the size and type of end configurations to suit the type of piping. Choose carefully, as the size affects the fluid flow rate.

Note:  
End configuration and size may be limited by the type of CUPLA.

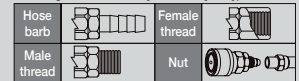

You can search "CUPLA" at our web site. ([www.nitto-kohki.co.jp/e/](http://www.nitto-kohki.co.jp/e/)) Please take a visit.

If you cannot find a suitable CUPLA product, please contact us via our web site or enter the above details in the "CUPLA Inquiry Form" at the end of this catalog and send it to us by fax or post.

## Symbols

### Quick reference symbols:

(1) Working pressure, (2) Type of valve structure, (3) Applicable fluids, are given on each product page to help you to quickly select a suitable CUPLA product. Please use them as the guide to grasp each type selection.

### Working pressure





**1.0 MPa**  
{10 kgf/cm<sup>2</sup>}

### Valve structure

 Plug

 Socket

 Valve



Two-way shut-off

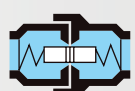

Two-way shut-off  
(Spill Reduction)



One-way shut-off





One-way shut-off





Straight through

### Applicable fluids

  
Air

  
Water

  
Hydraulic oil

  
Steam

  
Oxygen, Fuel Gas

  
Gas

  
Inert gas, Vacuum, Helium

  
Temperature control refrigerant

  
High purity chemicals

  
Heated oil

  
Powder

  
Solvent based paint

  
Food, Drinking water

# Glossary

The following terms are used in detailed information pages of each CUPLA. Refer to these terms when checking CUPLA specifications.

## International System of Units (SI Units)

Units stated in this catalog are based on SI Units. The old units, which are non-SI Units, are also written within parentheses side by side with SI Units for reference only.

## Glossary

### The Meaning of Each Letter in the Model Name

The model name of CUPLA indicates its size, whether plug or socket, and the end configuration. Rated pressure is also shown for some hydraulic couplings. Check the following tables to understand the model name implication before making your selection.

**200 - 20 S H** Model name (in case of HI CUPLA 200)

**Series name**

**End configuration** \*2

Symbol	H	M	F
Meaning	Hose barb	Male thread	Female thread

**Plug or Socket**

Symbol	P	S
Meaning	Plug	Socket

**Size** \*1

Symbol	1	2	3	4	6	8	10	12	16	20	24	32
Nominal diameter	1/8"	1/4"	3/8"	1/2"	3/4"	1"	1 1/4"	1 1/2"	2"	2 1/2"	3"	4"

\*1: The digit numbers of models for some products differs from those of symbols. For example, in case of HI CUPLA 20SH, not "20" but only "2" of the "20" corresponds to "2" of the symbol and indicates the nominal diameter of 1/4".

\*2: For a product with only one type of end configuration, this symbol is omitted. For example, 210 CUPLA have only female threaded end so the model indicates only the size and plug or socket identification.

### Body Material

This indicates the material that is used for the plug body or socket body that forms the flow path of fluid through CUPLA. Some products have internal components of a different material. Please check with us for details.

Body Material		Major applicable fluid
Common name	Mark	
Brass	BRASS	Air, Water, Oil
Iron, Steel	STEEL	Air, Oil
Stainless steel	SUS	Air, Water, Oil

Please refer to Page 174 for body material selection table.

### Size

This indicates the nominal size of the pipe thread connection or of the hose to be used.

### Working Pressure

The normal allowable fluid pressure under continuous use. Exceeding the working pressure may cause damage and leakage.

### Pressure Loss

This shows the loss of pressure when fluid runs through the coupling set. They are measured values at our testing facilities. May differ according to the installation/piping method and operating conditions.

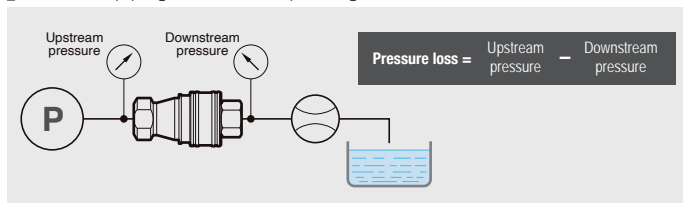

### Minimum Cross-Sectional Area

This shows the minimum cross-sectional area of the fluid path when CUPLA is connected. The position is different in some products.

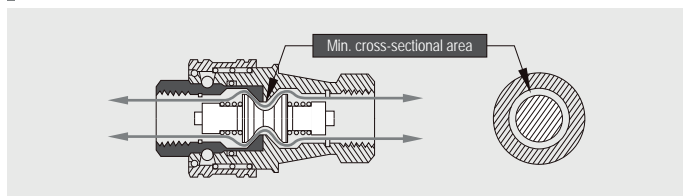

### Seal Material

This shows the material used to seal CUPLA, usually an O-ring. The standard material is nitrile butadiene rubber. For materials other than those shown below, please specify such as silicone (SI), butyl (IIR), Kalrez (KL) or rubber for food, depending on your application.

#### Properties of rubbers used for O-rings

Seal material	Working Temperature Range	Features
Nitrile rubber	-20°C to +80°C	Standard seal with excellent oil resistance.
Hydrogenated nitrile rubber	-20°C to +120°C	Compared with the standard nitrile rubber, the seal material is more heat and weather resistant.
Fluoro rubber	-20°C to +180°C	Excellent for heat, weather, and oil resistance. Applicable to wide range of applications.
Chloroprene rubber	-20°C to +80°C	Excellent weather resistance. In addition, the seal material can also be used for refrigeration oil and refrigerant applications such as HFC-134a.
Ethylene-propylene rubber	-40°C to +150°C	Excellent resistance to steam and hot water, also excellent resistance to weather and ozone.
Perfluoroelastomer	0°C to +50°C	Excellent resistance to chemical and solvents.

Note: Even among rubber materials of the same category, the working temperature range differs depending upon the design of CUPLA. For details, see the specifications of each CUPLA series. As for the Nitto Kohki symbol for rubber material, fluoro rubber is designated as "FKM" for example. The above are general features, but the seal resistance depends on fluid temperature, fluid concentration, and additives contained in the fluid.

### Working Temperature Range

This shows the minimum and maximum working temperature range of the seal material used in the product. Continuous use at the minimum or maximum temperature is not recommended. Please contact us for consultation. The operable temperature range depends on the operating conditions.

### Valve Structure

<b>Two-way shut-off</b>		Automatic shut-off valves are mounted in both plug and socket. The valves prevent spill out of fluid from the lines on disconnection.	
<b>Two-way shut-off (Spill Reduction)</b>		"Two-way shut-off" with spill reduction design allows extremely little admixture of air on connection and minimizes fluid spill out on disconnection.	
<b>One-way shut-off</b>		This design prevents fluid outflow only from the socket side on disconnection. Also available are plugs with an automatic shut-off valve.	
<b>Straight through</b>		Shut-off valve is equipped neither in plug nor in socket. Fluid flows out from either side on disconnection.	

### Suitability for Vacuum

Indicates if it has necessary performance required for vacuum applications. (Note that the performance in connected state differs from that of disconnected state.)

### Interchangeability

Indicates whether the plug or socket of different series, types or models can be connected with each other.

### Maximum Tightening Torque, Tightening Torque Range

Indicates suitable torque value or range considering of the balance between leakage by loose fit and damage by structural stress when installing CUPLA.





### Flow Direction

The design of some couplings may restrict the fluid flow direction to one way only. Check the suggested direction before installing.

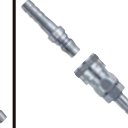

# Guide for Selecting “NITTO KOHKI” Standard CUPLA

This chart will let you quickly select an appropriate CUPLA product for your application. For technical data, please refer to the detailed information pages of each product, Seal Material Selection Table and Body Material Selection Table at the end of this catalog.









Applicable fluid		For Low Pressure (Air)							
Name		MICRO CUPLA	SMALL CUPLA	COMPACT ZEROSPILL CUPLA	COMPACT CUPLA	CUBE CUPLA	SUPER CUPLA	HI CUPLA	HI CUPLA BL
Photo									
Body material • Working pressure (MPa)	Brass	1.0	1.0		1.0			1.0	
	Stainless steel	1.0		1.0	1.0			1.5	1.5
	Steel						1.0	1.5	1.5
	Plastic					1.0			
	Others						1.0		
Body surface treatment		Plated (Brass only)	Chrome plated	Nickel plated (Socket only)	—	—	Chrome plated (Steel only)	Chrome plated (Steel only)	Chrome plated (Steel only)
Size	1/8"	○	○	○	○	○	○	○	
	1/4"		○	○			○	○	○
	5/16"								
	3/8"							○	○
	1/2"							○	○
	3/4"							○	
	1"							○	
	1 1/4"								
	1 1/2"								
	2"								
	2 1/2"								
	3"								
	4"								
Others	○	○		○	○	○	○		○
Working temperature range		-20°C to +80°C (NBR)	-20°C to +80°C (NBR)	-10°C to +100°C (EPDM)	-20°C to +180°C (FKM)	-20°C to +60°C (NBR)	-20°C to +80°C (NBR)	-20°C to +80°C (NBR)	-20°C to +80°C (NBR)
Seal material		NBR, FKM	NBR	EPDM	FKM, EPDM	NBR	NBR	NBR, FKM	NBR
Connection method	Manual				○			○	○
	Push-to-connect	○	○	○		○	○		
Valve structure	Two-way shut-off				○	○			
	Two-way shut-off (Spill Reduction)			○					
	One-way shut-off	○	○			○	○	○	○
	Straight through					○			
Detailed information page		23	27	29	31	33	37	39	41

**CUBE CUPLA**  
Select from All five colors  
See page 33 to 36 for details.









# Guide for Selecting "NITTO KOHKI" Standard CUPLA

This chart will let you quickly select an appropriate CUPLA product for your application. For technical data, please refer to the detailed information pages of each product, Seal Material Selection Table and Body Material Selection Table at the end of this catalog.

Applicable fluid		For Low Pressure (Air)							
Name		HI CUPLA 200	HI CUPLA for Connection to Braided Hoses	NUT CUPLA ROTARY NUT CUPLA	NUT CUPLA 200	LOCK CUPLA 200	HI CUPLA Two Way Type	FULL BLOW CUPLA	PURGE HI CUPLA PVR
Photo									
Body material • Working pressure (MPa)	Brass		1.0						
	Stainless steel								
	Steel	1.5	1.5	1.5	1.5	1.5	1.5		
	Plastic								
	Others							1.5	1.5
Body surface treatment		Chrome plated	Chrome plated (Steel only)	Chrome plated	Chrome plated	Chrome plated	Chrome plated	—	—
Size	1/8"								
	1/4"	○					○	○	
	5/16"								
	3/8"	○					○	○	
	1/2"	○					○	○	○
	3/4"								○
	1"								○
	1 1/4"								
	1 1/2"								
	2"								
	2 1/2"								
	3"								
	4"								
Others	○	○	○	○	○	○	○		
Working temperature range		-20°C to +60°C (NBR)	-20°C to +80°C (NBR)	-20°C to +60°C (NBR)	-20°C to +60°C (NBR)	-20°C to +60°C (NBR)	-20°C to +80°C (NBR)	-20°C to +60°C (NBR)	-20°C to +60°C (NBR)
Seal material		NBR	NBR	NBR	NBR	NBR	NBR, FKM	NBR	NBR
Connection method	Manual		○	○			○		
	Push-to-connect	○			○	○		○	○
Valve structure	Two-way shut-off								
	Two-way shut-off (Spill Reduction)								
	One-way shut-off	○	○	○	○	○	○	○	○
	Straight through								
Detailed information page		43	45	45	45	47	48	49	51

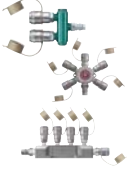
# Guide for Selecting “NITTO KOHKI” Standard CUPLA









This chart will let you quickly select an appropriate CUPLA product for your application. For technical data, please refer to the detailed information pages of each product, Seal Material Selection Table and Body Material Selection Table at the end of this catalog.

Applicable fluid		For Low Pressure (Air)							
Name		PURGE HI CUPLA	PURGE LINE CUPLA	ROTARY LINE CUPLA	LINE CUPLA 200T/L/S	ROTARY FULL BLOW LINE CUPLA	HI CUPLA ACE	ROTARY PLUG	TWIST PLUG
Photo									
Body material	Brass	1.0	1.0						
	Stainless steel								
	Steel							1.5	1.0
	Plastic						1.0, 1.5		
	Others			1.5	1.5	1.5			
Working pressure (MPa)									
Body surface treatment		Chrome plated	Chrome plated	Chrome plated	Chrome plated	—	—	Nickel plated	Nickel plated
Size	1/8"								○
	1/4"	○		○	○	○	○	○	○
	5/16"								
	3/8"	○					○	○	○
	1/2"	○	○	○	○	○			
	3/4"	○							
	1"								
	1 1/4"								
	1 1/2"								
	2"								
	2 1/2"								
	3"								
	4"								
Others			○		○	○			
Working temperature range		-20°C to +60°C (NBR)	-20°C to +60°C (NBR)	-20°C to +60°C (NBR)	-20°C to +60°C (NBR)	-20°C to +60°C (NBR)	-20°C to +60°C (NBR)	-20°C to +80°C (NBR)	-20°C to +60°C (NBR)
Seal material		NBR	NBR	NBR	NBR	NBR	NBR	NBR	NBR
Connection method	Manual			○					
	Push-to-connect	○	○		○	○	○		
Valve structure	Two-way shut-off								
	Two-way shut-off (Spill Reduction)								
	One-way shut-off	○	○	○	○	○	○		
	Straight through								
Detailed information page		53	54	55	57	59	61	63	64











# Guide for Selecting "NITTO KOHKI" Standard CUPLA

This chart will let you quickly select an appropriate CUPLA product for your application. For technical data, please refer to the detailed information pages of each product, Seal Material Selection Table and Body Material Selection Table at the end of this catalog.

Applicable fluid		For Low Pressure (Air)							For Oxygen and Fuel Gas
Name		PURGE PLUG	ANTI-VIBRATION PLUG HOSE	DUSTER CUPLA	NK CUPLA HOSE with FULL BLOW CUPLA	NK CUPLA HOSE with HI CUPLA ACE	NK CUPLA COIL HOSE with FULL BLOW CUPLA	NK CUPLA COIL HOSE with HI CUPLA ACE	MINI CUPLA
Photo									
Body material • Working pressure (MPa)	Brass								0.7
	Stainless steel								
	Steel	1.0							
	Plastic								
	Others		1.5	1.0	1.0	1.0	0.7	0.7	
Body surface treatment		Chrome plated	—	Chrome plated	Chrome plated (Plug only)	Chrome plated (Plug only)	Chrome plated (Plug only)	Chrome plated (Plug only)	—
Size	1/8"								○
	1/4"	○	○	○					○
	5/16"								○
	3/8"	○	○	○					○
	1/2"	○		○					
	3/4"								
	1"								
	1 1/4"								
	1 1/2"								
	2"								
	2 1/2"								
	3"								
	4"								
Others	○		○	○	○	○	○	○	○
Working temperature range		-20°C to +60°C (NBR)	—	-20°C to +60°C (NBR)	-5°C to +60°C (NBR)	-5°C to +60°C (NBR)	-5°C to +60°C (NBR)	-5°C to +60°C (NBR)	-20°C to +80°C (NBR)
Seal material		NBR	—	NBR	NBR	NBR	NBR	NBR	NBR
Connection method	Manual			○					
	Push-to-connect				○	○	○	○	○
Valve structure	Two-way shut-off								
	Two-way shut-off (Spill Reduction)								
	One-way shut-off			○	○	○	○	○	○
	Straight through								
Detailed information page		65	66	67	68	68	68	68	69



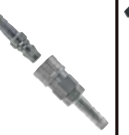





# Guide for Selecting “NITTO KOHKI” Standard CUPLA

This chart will let you quickly select an appropriate CUPLA product for your application. For technical data, please refer to the detailed information pages of each product, Seal Material Selection Table and Body Material Selection Table at the end of this catalog.

Applicable fluid		For Oxygen and Fuel Gas	For Low Pressure (Water)						
Name		MINI CUPLA SUPER	MICRO CUPLA	SMALL CUPLA	COMPACT ZERO SPILL CUPLA	COMPACT CUPLA	CUBE CUPLA	HI CUPLA	HI CUPLA ACE
Photo							 Choose from 5 colors 		
Body material	Brass	0.7	1.0	1.0		1.0		1.0	
	Stainless steel		1.0		1.0	1.0		1.5	
	Working pressure (MPa)	0.7							
	Steel								
	Plastic						1.0		1.0, 1.5
Others									
Body surface treatment		Chrome plated	Plated (Brass only)	Chrome plated	Nickel plated (Socket only)	—	—	—	—
Size	1/8"		○	○	○	○	○	○	
	1/4"	○		○	○			○	○
	5/16"	○							
	3/8"	○						○	○
	1/2"							○	
	3/4"							○	
	1"							○	
	1 1/4"								
	1 1/2"								
	2"								
	2 1/2"								
	3"								
	4"								
Others	○	○	○		○	○		○	
Working temperature range		-20°C to +80°C (NBR)	-20°C to +80°C (NBR)	-20°C to +80°C (NBR)	-10°C to +100°C (EPDM)	-20°C to +180°C (FKM)	-20°C to +60°C (NBR)	-20°C to +80°C (NBR)	-20°C to +60°C (NBR)
Seal material		NBR	NBR, FKM	NBR	EPDM	FKM, EPDM	NBR	NBR, FKM	NBR
Connection method	Manual					○		○	
	Push-to-connect	○	○	○	○		○		○
Valve structure	Two-way shut-off					○	○		
	Two-way shut-off (Spill Reduction)				○				
	One-way shut-off	○	○	○			○	○	○
	Straight through						○		
Detailed information page		71	23	27	29	31	33	39	61

# Guide for Selecting "NITTO KOHKI" Standard CUPLA









This chart will let you quickly select an appropriate CUPLA product for your application. For technical data, please refer to the detailed information pages of each product, Seal Material Selection Table and Body Material Selection Table at the end of this catalog.

Applicable fluid		For Low Pressure (Water)		For Medium Pressure / For Low Pressure					
Name		MOLD CUPLA	MOLD CUPLA High Flow Type	LEVER LOCK CUPLA	TSP CUPLA	TSP CUPLA with Ball Valve	SP CUPLA Type A	HOT WATER CUPLA HW Type	ZEROSPILL CUPLA
Photo									
Body material • Working pressure (MPa)	Brass	1.0	1.0		5.0, 3.0, 2.0, 1.5	1.0	5.0, 3.0, 2.0, 1.5	2.0	3.5
	Stainless steel			1.8, 1.6, 1.1	7.5, 4.5, 3.0, 2.0		7.5, 4.5, 3.0, 2.0		3.5
	Steel				7.5, 4.5, 3.0, 2.0		7.5, 4.5, 3.0, 2.0		
	Plastic			0.5, 0.2					
	Others			1.8, 1.1, 0.9, 0.7					
Body surface treatment		—	—	—	Nickel plated (Steel only)	—	Nickel plated (Steel only)	Nickel plated	—
Size	1/8"	○			○		○		
	1/4"	○	○		○	○	○	○	○
	5/16"								
	3/8"	○	○		○	○	○	○	○
	1/2"		○		○	○	○	○	○
	3/4"			○	○	○	○		○
	1"			○	○	○	○		○
	1 1/4"			○	○		○		
	1 1/2"			○	○		○		
	2"			○	○		○		
	2 1/2"			○					
	3"			○					
	4"			○					
Others	○			○					
Working temperature range		-20°C to +80°C (NBR)	-20°C to +80°C (NBR)	-20°C to +80°C (NBR) +5°C to +50°C (PP body)	-20°C to +80°C (NBR)	-5°C to +120°C (FKM)	-20°C to +80°C (NBR)	-20°C to +180°C (FKM)	-20°C to +80°C (NBR)
Seal material		NBR, FKM	NBR, FKM	NBR, FKM, SI, EPDM	NBR, FKM, EPDM	FKM	NBR, FKM, EPDM	FKM	NBR, FKM, EPDM
Connection method	Manual			○	○	○	○	○	
	Push-to-connect	○	○						○
Valve structure	Two-way shut-off						○	○	
	Two-way shut-off (Spill Reduction)								○
	One-way shut-off	○	○			○			
	Straight through	○	○	○	○				
Detailed information page		73	75	77	81	83	85	87	89



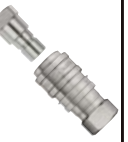

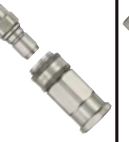





# Guide for Selecting “NITTO KOHKI” Standard CUPLA

This chart will let you quickly select an appropriate CUPLA product for your application. For technical data, please refer to the detailed information pages of each product, Seal Material Selection Table and Body Material Selection Table at the end of this catalog.

Applicable fluid		For High Pressure							
Name		HSP CUPLA	HYP HSP CUPLA	210 CUPLA	HSU CUPLA	S210 CUPLA	280 CUPLA	350 CUPLA	FLATFACE CUPLA F35
Photo									
Body material • Working pressure (MPa)	Brass								
	Stainless steel				21.0	20.6			
	Steel	20.6, 18.0, 14.0	20.6	20.6			31.5, 27.5	34.5	35
	Plastic								
	Others								
Body surface treatment		Nickel plated	Nickel plated	Nickel plated	—	—	Bright chromate conversion coating	Nickel plated	Nickel plated
Size	1/8"								
	1/4"	○	○	○	○	○	○	○	○
	5/16"								
	3/8"	○	○	○	○	○	○	○	○
	1/2"	○	○	○	○	○	○	○	○
	3/4"	○	○	○	○	○	○	○	○
	1"	○	○	○	○	○	○	○	○
	1 1/4"	○						○	
	1 1/2"	○						○	
	2"	○							
	2 1/2"								
	3"								
	4"								
	Others								
Working temperature range		-20°C to +80°C (NBR)	-20°C to +80°C (NBR)	-20°C to +80°C (NBR)	-20°C to +120°C (HNBR)	-20°C to +180°C (FKM)	-20°C to +80°C (NBR)	-20°C to +180°C (FKM)	-20°C to +180°C (FKM)
Seal material		NBR, FKM	NBR	NBR, FKM	HNBR	FKM, NBR	NBR	FKM	FKM
Connection method	Manual	○	○	○	○	○	○		
	Push-to-connect							○	○
Valve structure	Two-way shut-off	○	○	○	○	○	○		
	Two-way shut-off (Spill Reduction)							○	○
	One-way shut-off								
	Straight through								
Detailed information page		91	95	97	99	101	103	105	107



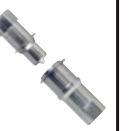





# Guide for Selecting “NITTO KOHKI” Standard CUPLA

This chart will let you quickly select an appropriate CUPLA product for your application. For technical data, please refer to the detailed information pages of each product, Seal Material Selection Table and Body Material Selection Table at the end of this catalog.

Applicable fluid		For High Pressure			For Multi-Port Connection (Manual)				
Name		FLATFACE CUPLA FF	450B CUPLA	700R CUPLA	MULTI CUPLA MAM Type	MULTI CUPLA MAM-B Type	MULTI CUPLA MAM-A Type	MULTI CUPLA MAM-A-SP Type	MULTI CUPLA MAM-A-ZEL Type
Photo									
Body material • Working pressure (MPa)	Brass				0.7	1.0	1.0	1.0	1.0
	Stainless steel								
	Steel	35	44.1	68.6					
	Plastic								
	Others								
Body surface treatment		Nickel plated	Nickel plated	Nickel plated	Chrome plated	Nickel plated	Nickel plated	Nickel plated	Nickel plated
Size	1/8"				○	○		○	
	1/4"					○	○	○	○
	5/16"								
	3/8"	○	○	○			○	○	○
	1/2"	○		○			○	○	○
	3/4"	○							
	1"	○							
	1 1/4"								
	1 1/2"								
	2"								
	2 1/2"								
	3"								
	4"								
Others									
Working temperature range		-20°C to +80°C (NBR)	-20°C to +80°C (NBR)	-20°C to +80°C (NBR)	-20°C to +60°C (NBR)	-20°C to +180°C (FKM)	-20°C to +180°C (FKM)	-20°C to +180°C (FKM)	-20°C to +180°C (FKM)
Seal material		NBR	NBR, FKM	NBR, FKM	NBR	FKM	FKM	FKM	FKM
Connection method	Manual		○	○					
	Push-to-connect	○							
Valve structure	Two-way shut-off		○	○		○	○	○	
	Two-way shut-off (Spill Reduction)	○							○
	One-way shut-off				○				
	Straight through								
Detailed information page		109	111	112	113	115	119	123	124









# Guide for Selecting “NITTO KOHKI” Standard CUPLA

This chart will let you quickly select an appropriate CUPLA product for your application. For technical data, please refer to the detailed information pages of each product, Seal Material Selection Table and Body Material Selection Table at the end of this catalog.

Applicable fluid		For Multi-Port Connection (Manual)		For Multi-Port Connection (Automatic)				For High Purity Chemicals	
Name		MULTI CUPLA MAM-B Type Plate	MULTI CUPLA MAM-A Type Plate	MULTI CUPLA MAS Type	MULTI CUPLA MAT Type	MULTI CUPLA MALC-01 Type	MULTI CUPLA MALC-SP Type	MULTI CUPLA MALC-HSP Type	SEMICON CUPLA SP Type
Photo									
Body material • Working pressure (MPa)	Brass	—	—			1.0			
	Stainless steel	—	—	7.0	7.0		7.5, 5.0, 1.5		0.2
	Steel	—	—					25.0, 21.0	
	Plastic	—	—						
	Others	—	—						
Body surface treatment		—	—	Nickel plated	Nickel plated	Nickel plated	Nickel plated	Nickel plated	Electropolished
Size	1/8"	○				○	○	○	○
	1/4"	○	○	○	○		○	○	○
	5/16"								
	3/8"		○	○	○		○	○	○
	1/2"		○	○	○		○	○	○
	3/4"			○	○		○	○	○
	1"			○	○		○	○	○
	1 1/4"								
	1 1/2"						○		
	2"								
	2 1/2"								
	3"								
	4"								
Others						○	○	○	
Working temperature range		—	—	-20°C to +180°C (FKM)	-20°C to +180°C (FKM)	-20°C to +80°C (NBR)	-20°C to +180°C (FKM)	-20°C to +180°C (FKM)	0°C to +50°C (FKM)
Seal material		—	—	FKM	FKM	NBR	FKM	FKM	FKM, EPDM, P, KL
Connection method	Manual								○
	Push-to-connect								
Valve structure	Two-way shut-off	—	—	○	○				○
	Two-way shut-off (Spill Reduction)	—	—				○	○	
	One-way shut-off	—	—			○			
	Straight through	—	—						
Detailed information page		126	128	131	131	133	135	139	143

# Guide for Selecting "NITTO KOHKI" Standard CUPLA

This chart will let you quickly select an appropriate CUPLA product for your application. For technical data, please refer to the detailed information pages of each product, Seal Material Selection Table and Body Material Selection Table at the end of this catalog.

Applicable fluid		For High Purity Chemicals					For Inert Gas and Vacuum		For Paint
Name		SEMICON CUPLA SCS Type	SEMICON CUPLA SCY Type	SEMICON CUPLA SCT Type	SEMICON CUPLA SCAL Type	SEMICON CUPLA SCF Type	SP-V CUPLA Type A	PCV PIPE CUPLA	PAINT CUPLA
Photo									
Body material • Working pressure (MPa)	Brass						5.0, 3.0	4.5	
	Stainless steel	0.2	0.2				7.5, 4.5		1.0 (Plug)
	Steel								
	Plastic			0.2	0.2	0.2			
	Others								1.0 (Socket)
Body surface treatment		Electropolished	Electropolished	—	—	—	—	—	—
Size	1/8"	○	○						
	1/4"	○	○	○	○		○	○	
	5/16"								
	3/8"	○	○	○	○	○	○	○	○
	1/2"	○	○	○	○	○	○		
	3/4"	○	○	○	○		○		
	1"	○	○	○					
	1 1/4"								
	1 1/2"								
	2"								
	2 1/2"								
	3"								
	4"								
	Others					○		○	
Working temperature range		0°C to +50°C (P)	0°C to +50°C (P)	+5°C to +50°C (FKM)	+5°C to +50°C (P)	+5°C to +50°C (FKM)	-20°C to +80°C (CR)	-20°C to +80°C (CR)	0°C to +50°C (PFA)
Seal material		P (O-ring for socket)	P, PTFE (Packing seal for socket)	FEP-coated FKM (O-ring for socket)	P (O-ring for socket)	FEP-coated FKM (O-ring for socket)	CR, FKM, HNBR	CR, FKM, HNBR	PFA
Connection method	Manual	○	○	○			○	○	○
	Push-to-connect				○	○			
Valve structure	Two-way shut-off	○	○	○		○	○		
	Two-way shut-off (Spill Reduction)				○				
	One-way shut-off								○
	Straight through							○	
Detailed information page		144	145	146	147	148	149	151	153



# Guide for Selecting “NITTO KOHKI” Standard CUPLA

This chart will let you quickly select an appropriate CUPLA product for your application. For technical data, please refer to the detailed information pages of each product, Seal Material Selection Table and Body Material Selection Table at the end of this catalog.

Applicable fluid		For Food
Name		HYGIENIC CUPLA Easy Wash Type
Photo		
Body material • Working pressure (MPa)	Brass	
	Stainless steel	1.0
	Steel	
	Plastic	
	Others	
Body surface treatment		Buff finish #400 (liquid contact part)
Size	1/8"	
	1/4"	
	5/16"	
	3/8"	
	1/2"	
	3/4"	
	1"	
	1 1/4"	
	1 1/2"	
	2"	
	2 1/2"	
	3"	
	4"	
Others	○	
Working temperature range		0°C to +110°C (SI)
Seal material		SI, FKM, EPDM
Connection method	Manual	
	Push-to-connect	○
Valve structure	Two-way shut-off	
	Two-way shut-off (Spill Reduction)	
	One-way shut-off	
	Straight through	○
Detailed information page		155

# Semi-standard CUPLA Series

“Semi-standard CUPLA Series” are products with an already established record but are not standard stock items.

## CUPLA Safety Mechanism

### CUPLA with Single Lock (BL/PL)

P157

Accidental disconnection prevention mechanism



### CUPLA with Safety Lock (SL)

P157

Accidental disconnection prevention mechanism



## For High Pressure

### HSP-DC CUPLA

P158

For hydraulic pressure up to 20.6 MPa (210 kgf/cm<sup>2</sup>)



Working pressure : 20.6 MPa (210 kgf/cm<sup>2</sup>)  
Body material : Special steel (Nickel plated)  
Application : 1/4" to 1"  
Seal material : NBR

### TSP-HP CUPLA (for High Pressure)

P162

High pressure and general purpose type

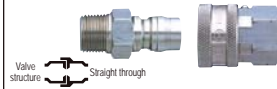

Working pressure : 9.0 MPa (92 kgf/cm<sup>2</sup>)  
Body material : Stainless steel  
Application : 1/4" to 1/2"  
Seal material : NBR, EPDM

## For Temperature Controllers

### HI FLOW CUPLA

P159

For piping to control temperatures  
Applicable fluid: Water, Heat transfer fluids



Working pressure : 1.0 MPa (10 kgf/cm<sup>2</sup>)  
Body material : Stainless steel, Brass  
Application : 1/4" to 1/2"  
Seal material : EPDM, FKM

### HI FLOW CUPLA BI Type

P160

HI FLOW CUPLA with ferrule flange mount  
Applicable fluid: Water, Heat transfer fluids



Working pressure : 1.0 MPa (10 kgf/cm<sup>2</sup>)  
Body material : Stainless steel  
Application : 1/8" to 1/2"  
Seal material : EPDM, FKM

## For Medium Pressure

### SP CUPLA Type A PV Type

P161

Connectable with residual pressure with Purge Valve



Working pressure : 2.0 to 4.5 MPa (20 to 46 kgf/cm<sup>2</sup>)  
Body material : Brass, Stainless steel  
Application : Rc 3/4 to Rc 1 1/2  
Seal material : NBR

### PLASTIC CUPLA BC Type

P162

Valveless type for low pressure air piping



Working pressure : 0.07 MPa (0.7 kgf/cm<sup>2</sup>)  
Body material : Plastic  
Application : 1/4", 3/8"  
Seal material : NBR

## When placing your order

Please select your appropriate combination from the column in each product page (on the right beside the product name) then decide the seal and body materials from the selection tables listed at the end of the catalog.

# Accessories

## Accessories

### DIP MOLD DUST CAP

P163

DUST CAPS for HI CUPLA, SP CUPLA Type A, TSP CUPLA, ZEROSPILL CUPLA and HYDRAULIC CUPLA



### SAFETY CAP

P163

Metal caps for HI CUPLA Series, SP CUPLA Type A, TSP CUPLA and HYDRAULIC CUPLA



Semi-standard

### DUST CAP

P164

DUST CAP Plastic Cap for HI CUPLA Series and FULL BLOW CUPLA



For FULL BLOW CUPLA

For HI CUPLA Series

### DUST CAP

P164

Dedicated polyethylene cap for HYGIENIC CUPLA



### SLEEVE COVER

P164

Plastic cover for FULL BLOW CUPLA



### PROTECTION COVER

P164

Plastic Cover for NUT CUPLA and FULL BLOW CUPLA Nut Type



### SLEEVE STOPPER

P165

Sleeve Stopper for SP CUPLA Type A



### ACCESSORIES FOR O-RING MAINTENANCE

P165

Jigs & grease for replacement of O-rings for couplings For SP CUPLA Type A, TSP CUPLA, HOT WATER CUPLA, ZEROSPILL CUPLA, HSP CUPLA, HSU CUPLA and HYGIENIC CUPLA



## For Medium Pressure

### SP CUPLA Type A PV Type

P161

Connectable with residual pressure with Purge Valve



Working pressure : 2.0 to 4.5 MPa (20 to 46 kgf/cm<sup>2</sup>)  
Body material : Brass, Stainless steel  
Application : Rc 3/4 to Rc 1 1/2  
Seal material : NBR

## For Low Pressure (air)

### PLASTIC CUPLA BC Type

P162

Valveless type for low pressure air piping



Working pressure : 0.07 MPa (0.7 kgf/cm<sup>2</sup>)  
Body material : Plastic  
Application : 1/4", 3/8"  
Seal material : NBR

### RESIDUAL PRESSURE RELEASE JIG

P166

Residual Pressure Release Jig for SP CUPLA and HYDRAULIC CUPLA



Semi-standard

### CUPLA ADAPTER for Braided Hose Connection

P166

Mounts on CUPLA plug / socket with female thread



### FLOW MONITOR Replaceable Flow Vane type

P167

For checking the water flow of mold cooling water pipes



NEW

### FLOW METER

P168

Flow meter with special valve for mold cooling line



### PURGE ADAPTER

P169

Residual Pressure Purge Adapter for Hydraulic Lines



### CUPLA CONNECTING JIG

P170

Connecting Jig for large CUPLA



















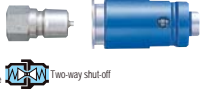
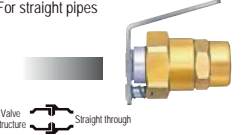
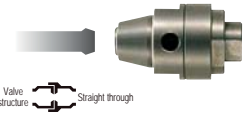

# Special Made-to-Order CUPLA

Nitto Kohki is developing couplings with various functions and specifications to suit respective user's applications. CUPLA products on this page are examples of such.

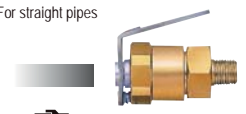

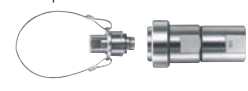
Special made-to-order couplings are supplied based upon the specific instructions / specifications detailed by the customer. Once written acceptance of our final drawing / specifications of CUPLA is received from the customer we formally accept this as a final order. It is essential, as the customer, to carry out a performance test of the special made-to-order CUPLA, in its specific usage conditions, for assurance of safety and adaptability to the hoses, pipes or devices used in the application. Use of the made-to-order CUPLA in any application or condition other than those specified in the design drawing, will exclude Nitto Kohki from any liabilities for any special, indirect or consequential loss or damages.

For Inert Gases	For Gases and Liquids (PIPE CUPLA Series)	For Inert Gas and Vacuum	For High Purity Chemicals	Automatic MULTI CUPLA
<b>CHARGE CUPLA cs Type</b> For industrial gases Connectable to SP-V CUPLA plugs  Valve structure:  Two-way shut-off Working pressure : 3.0 MPa (31 kgf/cm <sup>2</sup> ) Body material : Stainless steel (part Aluminum alloy and Brass) Application : 1/4" Seal material : CR, HNBR	<b>PCB CUPLA</b> For expanded pipes  Valve structure:  Straight through Working pressure : To be defined after consultation. Body material : Brass (part Stainless steel) Pipe sizes : To be complied with your requirements. Seal material : CR, FKM, NBR	<b>PCA CUPLA</b> Pipes for high pressure line  Valve structure:  Straight through Working pressure : To be defined after consultation. Body material : Brass (part Stainless steel and Steel) Pipe sizes : To be complied with your requirements. Seal material : CR, FKM, NBR	<b>SEMICON CUPLA SML Type</b> For semiconductor manufacturing equipment  Valve structure:  Two-way shut-off Working pressure : 0.2 MPa (2 kgf/cm <sup>2</sup> ) Body material : Stainless steel Application : 1/8", 1/4" Seal material : FKM, EPDM, others	<b>MULTI CUPLA AMCS-FA Type</b> Full automatic operation type  Valve structure:  Two-way shut-off Working pressure : To be decided after consultation. Body material : To be decided after consultation. Application : To be decided after consultation. Seal material : To be decided after consultation.
<b>CHARGE CUPLA CNR Type</b> For industrial gases Connectable to SP-V CUPLA plugs  Valve structure:  Two-way shut-off Working pressure : 4.5 MPa (46 kgf/cm <sup>2</sup> ) Body material : Stainless steel (part Aluminum alloy and Brass) Application : 1/4", 3/8", 1/2" Seal material : CR, HNBR	<b>PCBW CUPLA</b> For bulged pipes and spool pipes  Valve structure:  Straight through Working pressure : To be defined after consultation. Body material : Brass (part Stainless steel) Pipe sizes : To be complied with your requirements. Seal material : CR, FKM, NBR	<b>PCIO CUPLA</b> For pipes that have inner locking system  Valve structure:  Straight through Working pressure : To be defined after consultation. Body material : Stainless steel (part Brass) Pipe sizes : To be complied with your requirements. Seal material : CR, FKM, NBR	<b>SEMICON CUPLA scF Straight Type</b> For semiconductor manufacturing equipment *see page 148  Valve structure:  Two-way shut-off Working pressure : 0.2 MPa (2 kgf/cm <sup>2</sup> ) Body material : Fluorine contained resin Application : 3/8", 1/2" Seal material : FEP-coated FKM, Fluoro-resin	<b>MULTI CUPLA AMCS-SA Type</b> Semi-automatic type  Valve structure:  Two-way shut-off Working pressure : To be decided after consultation. Body material : To be decided after consultation. Application : To be decided after consultation. Seal material : To be decided after consultation.
<b>AUTO CUPLA AC Type</b> For industrial gases Connectable to SP-V CUPLA plugs  Valve structure:  Two-way shut-off Working pressure : 3.0 MPa (31 kgf/cm <sup>2</sup> ) Body material : Stainless steel (part Aluminum alloy and Brass) Application : 1/4", 3/8" Seal material : CR, HNBR, NBR	<b>PCP CUPLA</b> For bulged pipes and spool pipes  Valve structure:  Straight through Working pressure : To be defined after consultation. Body material : POM (Polyacetal), part Stainless steel Pipe sizes : To be complied with your requirements. Seal material : CR, FKM, NBR	<b>PCD CUPLA</b> For pipes of special shapes  Valve structure:  Straight through Working pressure : To be defined after consultation. Body material : Stainless steel (part Aluminum alloy) Pipe sizes : To be complied with your requirements. Seal material : CR, FKM, NBR	<b>For Water</b>	
<b>AUTO CUPLA acv Type</b> For industrial gases Connectable to SP-V CUPLA plugs  Valve structure:  Two-way shut-off Working pressure : 3.0 MPa (31 kgf/cm <sup>2</sup> ) Body material : Stainless steel (part Aluminum alloy and Brass) Application : 1/4", 3/8" Seal material : CR, HNBR, NBR	<b>PCBL CUPLA</b> For straight pipes  Valve structure:  Straight through Working pressure : To be defined after consultation. Body material : Stainless steel (part Brass) Pipe sizes : To be complied with your requirements. Seal material : CR, FKM, NBR	<b>AUTO CUPLA</b> For copper pipes  Valve structure:  Straight through Working pressure : To be defined after consultation. Body material : Stainless steel (part Brass) Pipe sizes : To be complied with your requirements. Seal material : CR, FKM, NBR	<b>AIRLESS CUPLA</b> For physical and chemical devices  Valve structure:  Two-way shut-off Working pressure : 3.0 MPa (31 kgf/cm <sup>2</sup> ) Body material : Stainless steel Application : 1/4" to 1" Seal material : FKM, EPDM	
<b>AIRLESS CUPLA cNA Type</b> For industrial gases  Valve structure:  Two-way shut-off Working pressure : 3.0 MPa (31 kgf/cm <sup>2</sup> ) Body material : Stainless steel Application : 3/8" Seal material : CR, HNBR	<b>PCL CUPLA</b> For straight pipes  Valve structure:  Straight through Working pressure : To be defined after consultation. Body material : Steel Pipe sizes : To be complied with your requirements. Seal material : CR, FKM, NBR	<b>SCREW CUPLA pcs Type</b> For vacuum and pressure testing Please consult with us for larger sizes.  Valve structure:  Straight through Working pressure : 3.0 MPa (31 kgf/cm <sup>2</sup> ) Body material : Steel (part Stainless steel) Application : 7/16" to 7/8" Seal material : CR, NBR, FKM	<b>For Manipulators</b>	
<b>PCW CUPLA</b> For straight pipes  Valve structure:  Straight through Working pressure : To be defined after consultation. Body material : Brass (part Steel) Pipe sizes : To be complied with your requirements. Seal material : CR, FKM, NBR	<b>For Pneumatics and Hydraulics</b>		<b>MP CUPLA</b> For manipulators  Valve structure:  Two-way shut-off Working pressure : 5.0 MPa (51 kgf/cm <sup>2</sup> ) Body material : Stainless steel Application : 1/4" to 1" Seal material : FKM, others	<b>SAFETY EQUIPMENT</b>
				<b>AUTOMATIC DISCONNECTION CUPLA</b> For fail safe system and automatic connection/disconnection applications  Valve structure:  Two-way shut-off Working pressure : To be decided after consultation. Body material : To be decided after consultation. Application : To be decided after consultation. Seal material : To be decided after consultation.
		<b>SCREW CUPLA ncm Type</b> For connecting pneumatic/hydraulic lines  Valve structure:  Straight through Working pressure : 14.0 MPa (142 kgf/cm <sup>2</sup> ) Body material : Steel (Plated) Application : 1/8" to 1" Seal material : NBR		

**When placing your order**  
 Please ask about the details, since CUPLA products in this group are special made-to-order items.

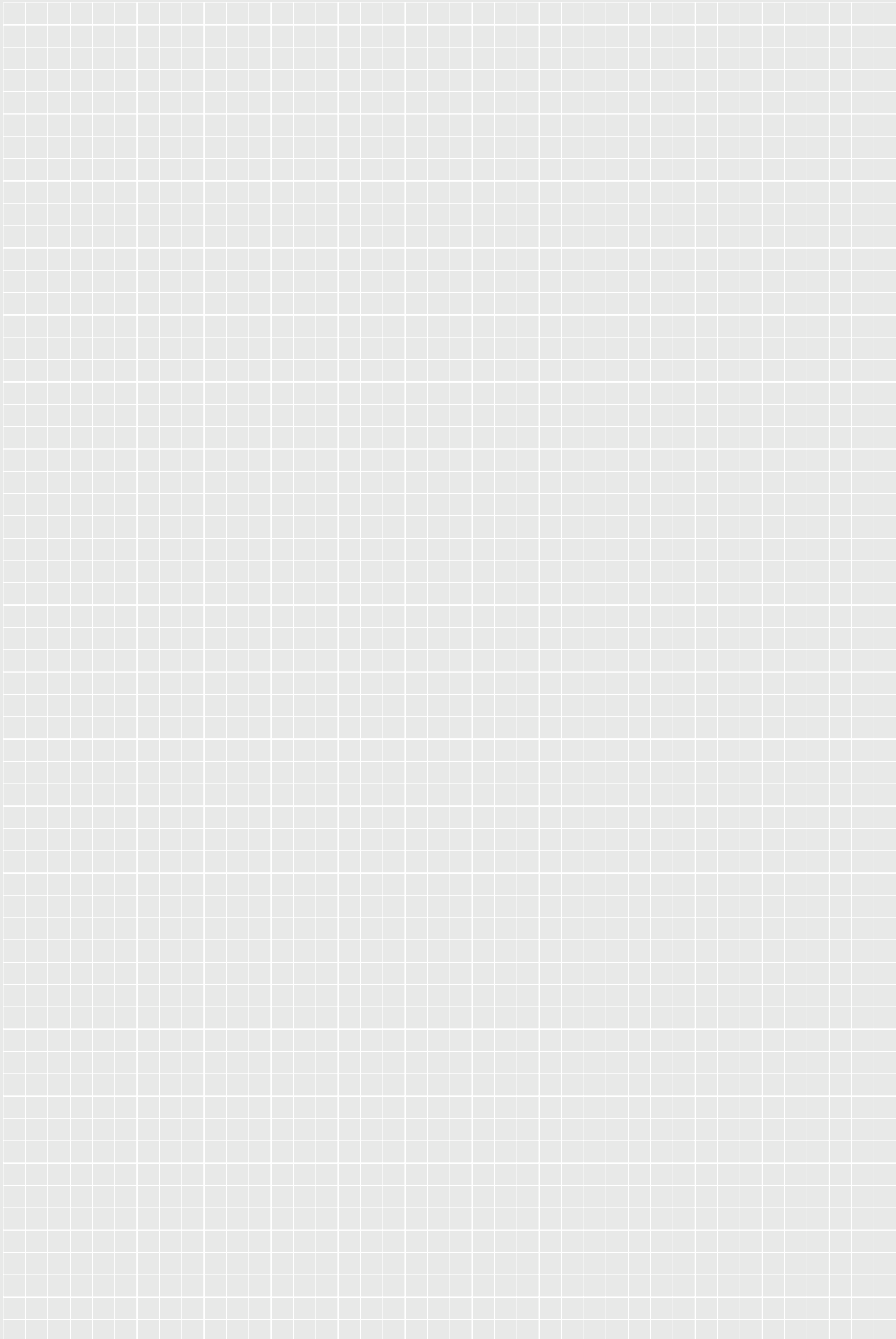

# HI CUPLA Series Interchangeability

Following plugs and sockets can be connected with each other

Plug	
Type	Model
HI CUPLA	17PH, 20PH, 30PH, 40PH
	10PM, 20PM, 30PM, 40PM
	20PF, 30PF, 40PF
	20PFF
	60PC, 80PC, 100PC
	90PN-BH
NUT CUPLA	50PN (10PAH), 60PN (20PAH), 65PN 80PN (30PAH), 85PN, 110PN (40PAH) 50PNG, 65PNG, 85PNG
	20PH-PLA, 30PH-PLA 20PM-PLA, 30PM-PLA 50PN-PLA, 60PN-PLA, 65PN-PLA, 80PN-PLA, 85PN-PLA 20PFF-PLA 50PNG-PLA, 65PNG-PLA, 85PNG-PLA
	RL-20PM, RL-30PM RL-20PFF
ROTARY PLUG	TS-10PM, TS-20PM, TS-30PM TS-20PFF
TWIST PLUG	PV-20PH, PV-30PH, PV-40PH PV-65PN, PV-85PN
PURGE PLUG	SHA-3-2R, SHA-3-3R
ANTI-VIBRATION PLUG HOSE	NKU-605B, NKU-610B, NKU-620B (65PNG) NKU-810B, NKU-820B (85PNG)
NK CUPLA HOSE with HI CUPLA ACE	NKU-605P, NKU-610P (65PNG) NKU-810P (85PNG)
NK CUPLA HOSE with FULL BLOW CUPLA	NKC-503B, NKC-505B (50PNG) NKC-603B, NKC-605B (65PNG)
NK CUPLA COIL HOSE with HI CUPLA ACE	NKC-603P, NKC-605P (65PNG)
NK CUPLA COIL HOSE with FULL BLOW CUPLA	RT Type (Inlet Port)
ROTARY LINE CUPLA	200T Type (Inlet Port)
LINE CUPLA 200	FBH-RT Type (Inlet Port)
ROTARY FULL BLOW LINE CUPLA	HA-T Type (Inlet Port)
HI CUPLA ACE T Type	02S20P (End Configuration)
SUPER CUPLA	

Can be connected with each other



Socket	
Model	Type
17SH, 20SH, 30SH, 40SH 10SM, 20SM, 30SM, 40SM, 60SM 20SF, 30SF, 40SF 90SN-BH	HI CUPLA
20SH-BL, 30SH-BL, 40SH-BL 20SM-BL, 30SM-BL, 40SM-BL 20SF-BL, 30SF-BL, 40SF-BL 65SN-BL, 80SN-BL, 85SN-BL	HI CUPLA BL
TW20SH, TW30SH, TW40SH TW20SM, TW30SM, TW40SM TW20SF, TW30SF, TW40SF	HI CUPLA TW Type
200-17SH, 200-20SH, 200-30SH, 200-40SH 200-20SM, 200-30SM, 200-40SM 200-20SF, 200-30SF, 200-40SF 200-60SC, 200-80SC, 200-100SC	HI CUPLA 200
FBH-20SH, FBH-30SH, FBH-40SH FBH-20SM, FBH-30SM, FBH-40SM FBH-20SF, FBH-30SF, FBH-40SF FBH-65SN, FBH-80SN, FBH-85SN, FBH-110SN	FULL BLOW CUPLA
50SN (10SAH), 60SN (20SAH), 65SN 80SN (30SAH), 85SN, 110SN (40SAH)	NUT CUPLA
200-50SN, 200-60SN, 200-65SN, 200-80SN 200-85SN, 200-110SN 200-50SNG, 200-65SNG, 200-85SNG	NUT CUPLA 200
65SNR, 85SNR 65SNRG, 85SNRG	ROTARY NUT CUPLA
DCS-20PH, DCS-30PH, DCS-40PH DCS-65PNG, DCS-85PNG	DUSTER CUPLA
L200-20SH, L200-30SH, L200-40SH L200-20SM, L200-30SM, L200-40SM L200-20SF, L200-30SF, L200-40SF L200-65SNRG, L200-85SNRG	LOCK CUPLA 200
PV-20SM, PV-30SM, PV-40SM	PURGE HI CUPLA
RE-PV-30 Type (Outlet Port)	PURGE LINE CUPLA
RT Type (Outlet Port), RE Type (Outlet Port)	ROTARY LINE CUPLA
200T Type (Outlet Port), 200L Type (Outlet Port) 200S Type (Outlet Port)	LINE CUPLA 200
FBH-RE Type (Outlet Port), FBH-RT Type (Outlet Port)	ROTARY FULL BLOW LINE CUPLA
HA-20SH, HA-30SH HA-20SM, HA-30SM, HA-50SN, HA-60SN HA-65SN, HA-80SN, HA-85SN HA-T Type (Outlet Port) HA-50SNG, HA-65SNG, HA-85SNG	HI CUPLA ACE
NKU-605B, NKU-610B, NKU-620B (HA-65SNG) NKU-810B, NKU-820B (HA-85SNG)	NK CUPLA HOSE with HI CUPLA ACE
NKU-605P, NKU-610P (FBH-65SNG) NKU-810P (FBH-85SNG)	NK CUPLA HOSE with FULL BLOW CUPLA
NKC-503B, NKC-505B (HA-50SNG) NKC-603B, NKC-605B (HA-65SNG)	NK CUPLA COIL HOSE with HI CUPLA ACE
NKC-603P, NKC-605P (FBH-65SNG)	NK CUPLA COIL HOSE with FULL BLOW CUPLA

Not interchangeable

Plug	
Type	Model
HI CUPLA	400PH, 600PH, 800PH 400PM, 600PM, 800PM 400PF, 600PF, 800PF
	200L Type (Inlet Port) 200S Type (Inlet Port)

Can be connected with each other



Socket	
Model	Type
400SH, 600SH, 800SH 400SM, 600SM, 800SM 400SF, 600SF, 800SF	HI CUPLA
PV-400SM, PV-600SM	PURGE HI CUPLA
PVR-400SH, PVR-600SH, PVR-800SH PVR-400SM, PVR-600SM, PVR-800SM PVR-400SF, PVR-600SF, PVR-800SF	PURGE HI CUPLA PVR Type



## Index

### Examples of air line connections using HI CUPLA group models

Air distribution is one of the typical piping systems. Various HI CUPLA Series models meet all needs of air piping from main supply, relays in factories, pipe end connections to pneumatic tools, and those of air piping within equipment. The following sketch gives you some examples of air piping using HI CUPLA Series and may serve as a good reference in selecting appropriate CUPLA products.

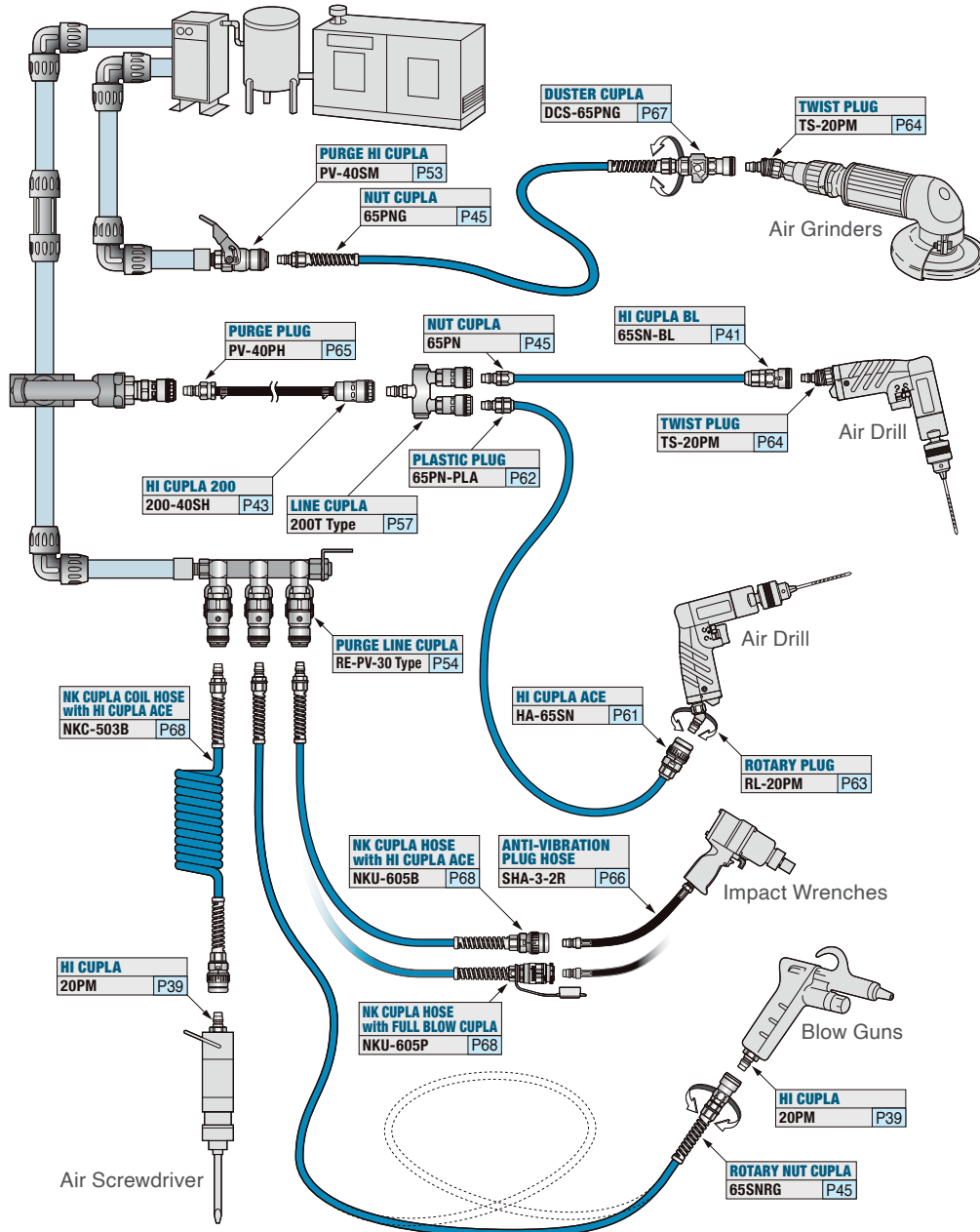



	Product Name	Page
<b>2</b>	210 CUPLA	97
	280 CUPLA	103
<b>3</b>	350 CUPLA	105
<b>4</b>	450B CUPLA	111
<b>7</b>	700R CUPLA	112
<b>A</b>	ANTI-VIBRATION PLUG HOSE	66
<b>C</b>	COMPACT CUPLA	31
	COMPACT ZEROSPILL CUPLA	29
	CUBE CUPLA	33
<b>D</b>	DUSTER CUPLA	67
<b>F</b>	FLATFACE CUPLA F35	107
	FLATFACE CUPLA FF	109
	FULL BLOW CUPLA	49
<b>H</b>	HI CUPLA	39
	HI CUPLA 200	43
	HI CUPLA ACE	61
	HI CUPLA BL	41
	HI CUPLA for Connection to Braided Hoses	45
	HI CUPLA Two Way Type	48
	HOT WATER CUPLA HW Type	87
	HSP CUPLA	91
	HSU CUPLA	99
	HYGIENIC CUPLA	155
	HYPER HSP CUPLA	95
<b>L</b>	LEVER LOCK CUPLA	77
	LINE CUPLA 200	57
	LOCK CUPLA 200	47
<b>M</b>	MICRO CUPLA	23
	MINI CUPLA	69
	MINI CUPLA SUPER	71
	MOLD CUPLA	73
	MOLD CUPLA High Flow Type	75
	MULTI CUPLA MALC-01 Type	133
	MULTI CUPLA MALC-HSP Type	139
	MULTI CUPLA MALC-SP Type	135
	MULTI CUPLA MAM-A Type	119
	MULTI CUPLA MAM-B Type	115
	MULTI CUPLA MAM Type	113
	MULTI CUPLA MAS Type	131
	MULTI CUPLA MAT Type	131
	MULTI CUPLA MAM-A-SP Type	123
	MULTI CUPLA MAM-A-ZEL Type	124
	MULTI CUPLA MAM-A Type Plate	125
	MULTI CUPLA MAM-B Type Plate	125
<b>N</b>	NK CUPLA COIL HOSE with FULL BLOW CUPLA	68
	NK CUPLA COIL HOSE with HI CUPLA ACE	68
	NK CUPLA HOSE with FULL BLOW CUPLA	68
	NK CUPLA HOSE with HI CUPLA ACE	68
	NUT CUPLA	45
	NUT CUPLA 200	45
<b>P</b>	PAINT CUPLA	153
	PCV PIPE CUPLA	151
	PURGE HI CUPLA	53
	PURGE HI CUPLA PVR Type	51
	PURGE LINE CUPLA	54
	PURGE PLUG	65
<b>R</b>	ROTARY FULL BLOW LINE CUPLA	59
	ROTARY LINE CUPLA	55
	ROTARY NUT CUPLA	45
	ROTARY PLUG	63
<b>S</b>	S210 CUPLA	101
	SEMICON CUPLA SCAL Type	147
	SEMICON CUPLA SCF Type	148
	SEMICON CUPLA SP Type	143
	SEMICON CUPLA SCS Type	144
	SEMICON CUPLA SCT Type	146
	SEMICON CUPLA SCY Type	145
	SMALL CUPLA	27
	SP CUPLA Type A	85
	SP-V CUPLA Type A	149
	SUPER CUPLA	37
<b>T</b>	TSP CUPLA	81
	TSP CUPLA with Ball Valve	83
	TWIST PLUG	64
<b>Z</b>	ZEROSPILL CUPLA	89



For Low Pressure

# MICRO CUPLA

For piping in pneumatic control devices

<p>Working pressure</p>  <p>1.0 MPa (10 kgf/cm<sup>2</sup>)</p>	<p>Valve structure</p>  <p>One-way shut-off</p>	<p>Applicable fluids</p>  <p>Air Water (Tube Fitter type is unsuitable for water.)</p>
---	--	---

**Compact, lightweight CUPLA with only 9.5 mm outer diameter. Push-to-connect operation. Tube Fitter type for even easier tube insertion.**

- Even though the valve is built in the socket, the sleeve outer diameter is confined to 9.5 mm.
- Push-to-connect design.
- Compact design for piping in narrow spaces.
- Plated brass and stainless steel bodies are available for excellent corrosion resistance.
- Available in various end configurations to satisfy a wide range of pneumatic applications.

Note: Fluid will flow out from the plug side when disconnected.  
Take necessary precaution if the fluid is water.



Specifications				
Body material		CUPLA : Brass (Plated), Stainless steel (SUS304) Tube Fitter Part : Brass (Plated) , Plastic		
Size	Thread	1/8" , M5×0.8		
	Tube barb	Tube ID ø3, ø4		
	Tube barb (Tube fitter) <sup>1)</sup>	Polyurethane tube: Outside Dia. ø4 ± 0.1, ø6 ± 0.1 Polyamide tube: Outside Dia. ø4 <sup>+0.05</sup> / <sub>-0.08</sub> , ø6 <sup>+0.05</sup> / <sub>-0.08</sub> Fluorine contained resin tube: Outside Dia. ø4 ± 0.05, ø6 ± 0.07		
Pressure unit	MPa	kgf/cm <sup>2</sup>	bar	PSI
Working pressure	1.0	10	10	145
Seal material <sup>2)</sup> Working temperature range <sup>3)</sup>	Seal material	Mark	Working temperature range	Remarks
	Nitrile rubber	NBR	-20°C to +80°C	Standard material
	Fluoro rubber	FKM	-20°C to +180°C	Made-to-order item

- Above specifications apply only to CUPLA. Maximum working pressure and working temperature range may vary depending on tube materials you use with and the working temperature.  
\*1: When connecting an extremely soft tube such as soft polyurethane or soft nylon, attach the insert ring specified by the tube manufacturer to the inner diameter of the tube to be connected.  
\*2: Combinations of the seal material and the valve material are as follows (Seal material/Valve material: NBR/Resin, FKM/Metal). For tube fitter type, the seal material is NBR only.  
\*3: The operable temperature range depends on the operating conditions.

Maximum Tightening Torque		Nm {kgf·cm}	
Size (Thread)		M5×0.8	R 1/8
Torque	Brass	1.3 {13}	5 {51}
	Stainless steel		7 {71}

**Flow Direction**

Fluid flow can be bi-directional when socket and plug are connected.

**Interchangeability**  
Sockets and plugs can be connected regardless of end configurations.

Minimum Cross-Sectional Area	(mm <sup>2</sup> )					
Model	MC-03SP	MC-04SP	MC-05SP	MC-10SP	Tube Fitter Type for 4 mm OD tube	Tube Fitter Type for 6 mm OD tube
Min. cross-sectional area	1.1	4.9	4.9	4.9	4.9	4.9

Suitability for Vacuum			53.0 kPa {400 mmHg}
Socket only	Plug only	When connected	
—	—	Operational	

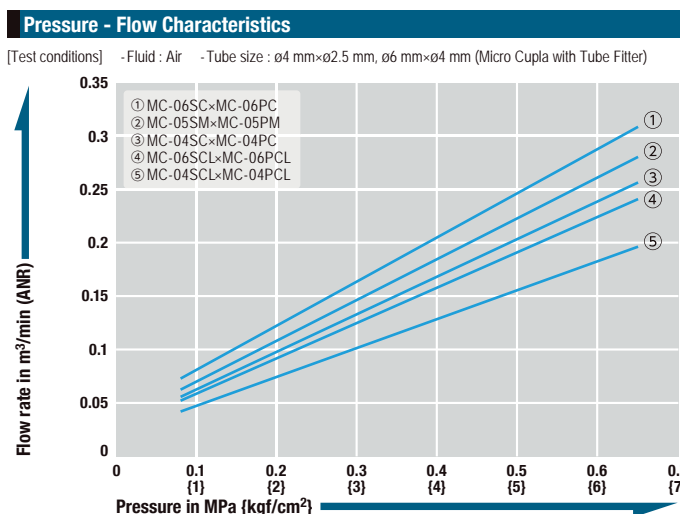

Models and Dimensions

**Plug PH type (Tube barb)**

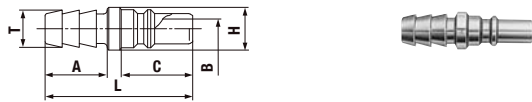

Model	Application (Tube)	Body material*Mass (g) Brass	Dimensions (mm)					
			L	C	A	øH	øT	øB
MC-03PH	3 mm ID	1.2	19	9.2	8	5.5	3.5	1.2
MC-04PH	4 mm ID	1.4	19	9.2	8	5.5	4.8	2.5

**Plug PM type (Male thread)**



Model	Application (Thread)	Body material*Mass (g) Brass	Dimensions (mm)					
			L	C	A	H(WAF)	T	øB
MC-05PM	M5×0.8	1.9	17	9.2	4.5	Hex.7	M5×0.8	2.5

**Plug PM type (Male thread)**



Model	Application (Thread)	Body material*Mass (g) Brass	Dimensions (mm)					
			L	C	H(WAF)	T	øB	
MC-10PM	Rc 1/8	9	26	9.2	Hex.11	R 1/8	2.5	

**Plug PHL type (Tube barb)**

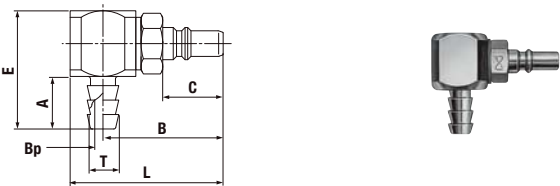

Model	Application (Tube)	Body material*Mass (g) Brass	Dimensions (mm)						
			L	C	A	B	E	øT	øBp
MC-04PHL	4 mm ID	9.4	(23.3)	9.2	8	(18.3)	18	4.8	2.5

Application Example

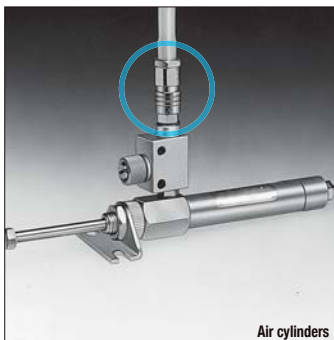

Always fix tubes with hose clamps when using hose barb types.

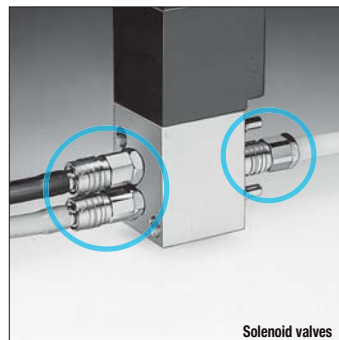

Always fix tubes with hose clamps when using hose barb types.

**Socket SH type (Tube barb)**

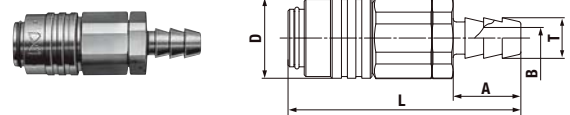

Model	Application (Tube)	Body material*Mass (g) Brass	Dimensions (mm)				
			L	øD	A	øT	øB
MC-03SH	3 mm ID	7	(27.5)	9.5	8	3.5	1.2
MC-04SH	4 mm ID	7.3	(27.5)	9.5	8	4.8	2.5

**Socket SM type (Male thread)**

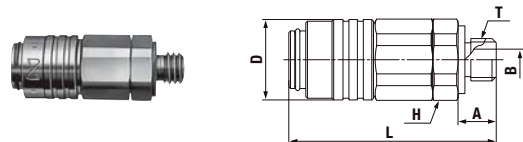

Model	Application (Thread)	Body material*Mass (g) Brass	Dimensions (mm)					
			L	øD	A	T	H(WAF)	øB
MC-05SM	M5×0.8	7.4	(24.5)	9.5	4.5	M5×0.8	Hex.9	2.5

**Socket SM type (Male thread)**

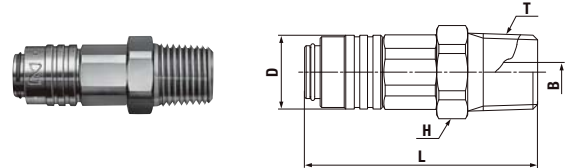

Model	Application (Thread)	Body material*Mass (g) Brass	Dimensions (mm)				
			L	øD	T	H(WAF)	øB
MC-10SM	Rc 1/8	13.1	(30)	9.5	R 1/8	Hex.11	3

**Socket SHL type (Tube barb)**

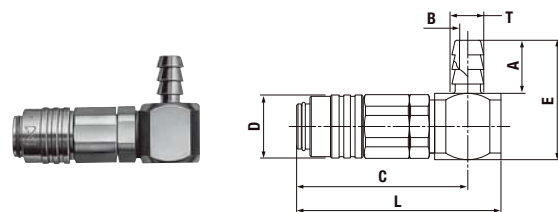

Model	Application (Tube)	Body material*Mass (g) Brass	Dimensions (mm)						
			L	C	E	A	øD	øT	øB
MC-04SHL	4 mm ID	14.8	(30.8)	(25.8)	18	8	9.5	4.8	2.5

**Socket SHB type (For panel mounting)**

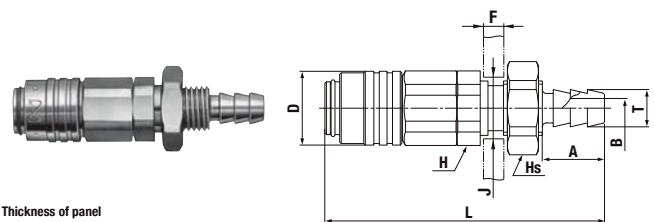

F: Thickness of panel  
øJ: Diameter of mounting hole

Model	Application (Tube)	Body material*Mass (g) Brass	Dimensions (mm)								
			L	A	øD	øT	øB	Hs(WAF)	øJ	H(WAF)	F
MC-04SHB	4 mm ID	11.5	(36)	8	9.5	4.8	2.5	Hex.11	7.1 <sup>+0.3</sup> <sub>0</sub>	Hex.9	1.2 to 3.5

Models and Dimensions (MICRO CUPLA with Tube Fitter)

WAF : WAF stands for width across flats.

**Plug** PC type (With Tube Fitter)

Model	Application (Tube)	Mass (g)	Dimensions (mm)			
			L	C	øT	øB
MC-04PC	4 mm OD	3	(21.7)	9.2	8	2.5
MC-06PC	6 mm OD	5	(25)	9.2	9.8	2.5

**Socket** SC type (With Tube Fitter)

Model	Application (Tube)	Mass (g)	Dimensions (mm)			
			L	øD	C	øT
MC-04SC	4 mm OD	9	(31.5)	9.5	(12)	8
MC-06SC	6 mm OD	11.5	(33.5)	9.5	(13)	9.8

**Plug** PCL type (With L-shaped Tube Fitter)

Model	Application (Tube)	Mass (g)	Dimensions (mm)				
			L	C	E	øT	øB
MC-04PCL	4 mm OD	10	(23.3)	9.2	(18.3)	8	2.5
MC-06PCL	6 mm OD	13.5	(24.3)	9.2	(18.8)	9.8	2.5

**Socket** SCL type (With L-shaped Tube Fitter)

Model	Application (Tube)	Mass (g)	Dimensions (mm)				
			L	E	øD	C	øT
MC-04SCL	4 mm OD	16	(30.8)	(25.8)	9.5	(10)	8
MC-06SCL	6 mm OD	19	(31.8)	(26.3)	9.5	(12.5)	9.8

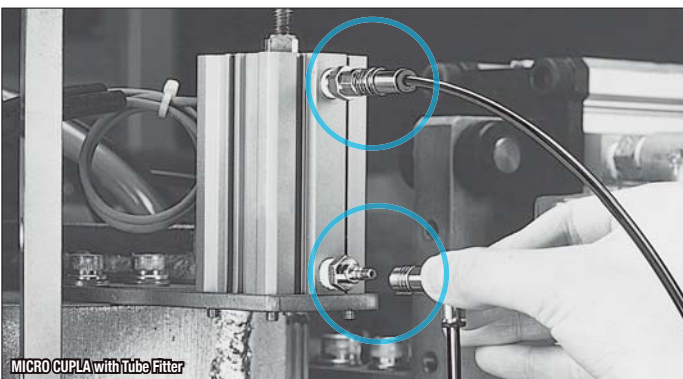

**Socket** SCB type (With Tube Fitter for panel mounting)

F: Thickness of panel  
øJ: Diameter of mounting hole

Model	Application (Tube)	Mass (g)	Dimensions (mm)						
			L	øD	øE	Hs(WAF)	H(WAF)	F	øJ
MC-04SCB	4 mm OD	15	(34)	9.5	16	Hex.13	Hex.13	3.5 or less	10.5 <sup>+0.3</sup> <sub>0</sub>
MC-06SCB	6 mm OD	18.5	(36)	9.5	18	Hex.15	Hex.15	3.5 or less	12.5 <sup>+0.3</sup> <sub>0</sub>

Models and Dimensions (MICRO LINE CUPLA)

WAF : WAF stands for width across flats.

**Socket** MC-03 type (MICRO LINE CUPLA with three branch ports)

Mass: 65 g  
• The branch body is made of aluminum alloy.

MC-05SM (3 pcs.)

3.2 mm dia. through hole (4 pcs.)

Dimensions (mm)

**Socket** MC-05 type (MICRO LINE CUPLA with 5 branch ports)

Mass: 101 g  
• The branch body is made of aluminum alloy.

MC-05SM (5 pcs.)

3.2 mm dia. through hole (4 pcs.)

Dimensions (mm)

**Socket** MC-10 type (MICRO LINE CUPLA with 10 branch ports)

Mass: 187 g  
• The branch body is made of aluminum alloy.

MC-05SM (10 pcs.)

3.2 mm dia. through hole (4 pcs.)

Dimensions (mm)



# MICRO CUPLA

## Stainless Steel Models

Highly Corrosion-resistant  
Stainless Steel MICRO CUPLA

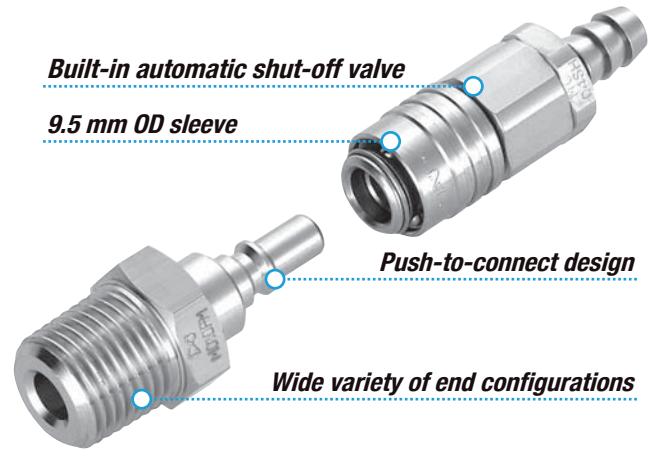

**Models and Dimensions (Stainless Steel)**

WAF : WAF stands for width across flats.

**Plug PH type (Hose barb)**

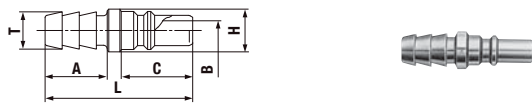

Model	Application (Tube)	Body material*Mass (g)	Dimensions (mm)						
		Stainless steel	L	C	A	øH	øT	øB	
MC-04PH	4 mm ID	1.3	19	9.2	8	5.5	4.8	2.5	

**Socket SH type (Hose barb)**

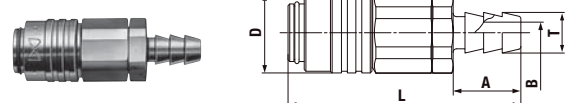

Model	Application (Tube)	Body material*Mass (g)	Dimensions (mm)				
		Stainless steel	L	øD	A	øT	øB
MC-04SH	4 mm ID	6.7	(27.5)	9.5	8	4.8	2.5

**Plug PM type (Male thread)**



Model	Application (Thread)	Body material*Mass (g)	Dimensions (mm)					
		Stainless steel	L	C	A	H(WAF)	T	øB
MC-05PM	M5×0.8	2.2	17	9.2	4.5	Hex.8	M5×0.8	2.5

**Socket SM type (Male thread)**

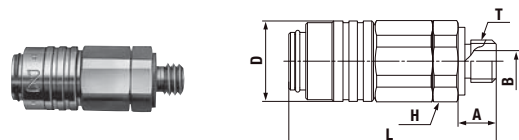

Model	Application (Thread)	Body material*Mass (g)	Dimensions (mm)					
		Stainless steel	L	øD	A	T	H(WAF)	øB
MC-05SM	M5×0.8	6.8	(24.5)	9.5	4.5	M5×0.8	Hex.9	2.5

**Plug PM type (Male thread)**



Model	Application (Thread)	Body material*Mass (g)	Dimensions (mm)				
		Stainless steel	L	C	H(WAF)	T	øB
MC-10PM	Rc 1/8	8.1	26	9.2	Hex.11	R 1/8	2.5

**Socket SM type (Male thread)**

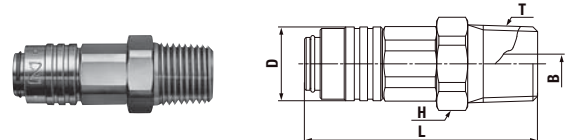

Model	Application (Thread)	Body material*Mass (g)	Dimensions (mm)				
		Stainless steel	L	øD	T	H(WAF)	øB
MC-10SM	Rc 1/8	12.1	(30)	9.5	R 1/8	Hex.11	3

**Plug PHL type (Hose barb)**

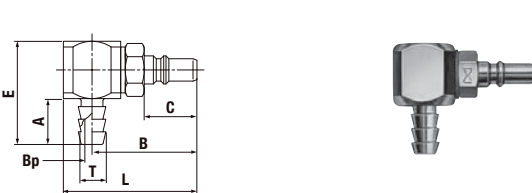

Model	Application (Tube)	Body material*Mass (g)	Dimensions (mm)						
		Stainless steel	L	C	A	B	E	øT	øBp
MC-04PHL	4 mm ID	9	(23.3)	9.2	8	(18.3)	18	4.8	2.5

**Socket SHL type (Hose barb)**

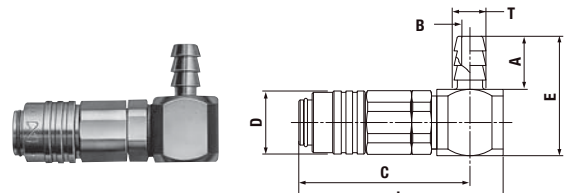

Model	Application (Tube)	Body material*Mass (g)	Dimensions (mm)						
		Stainless steel	L	C	E	A	øD	øT	øB
MC-04SHL	4 mm ID	13.6	(30.8)	(25.8)	18	8	9.5	4.8	2.5

**Socket SHB type (For panel mounting)**

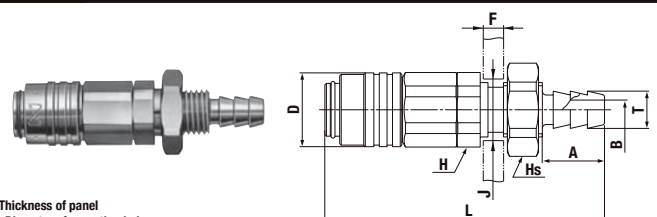

F: Thickness of panel  
øJ: Diameter of mounting hole

Model	Application (Tube)	Body material*Mass (g)	Dimensions (mm)									
		Stainless steel	L	A	øD	øT	øB	H(WAF)	øJ	H(WAF)	F	
MC-04SHB	4 mm ID	10.6	(36)	8	9.5	4.8	2.5	Hex.11	7.1 <sup>+0.3</sup> <sub>0</sub>	Hex.9	1.2 to 3.5	

For Low Pressure

# SMALL CUPLA

Lightweight and compact for use on air lines and scientific equipment

<b>Working pressure</b>	<b>Valve structure</b>	<b>Applicable fluids</b>	
1.0 MPa (10 kgf/cm <sup>2</sup> )	One-way shut-off	Air	Water (Tube Fitter type is unsuitable for water.)

## Lightweight and compact push-to-connect operation. Responding to requirements of modular combinations.

- Compact socket with built-in valve and 14 mm OD sleeve.
- Suits applications calling for compact and modular components.
- Just push in the plug to the socket for connection by easy one hand operation.
- Plated brass for corrosion resistance adopted for the body.
- Stable performance for long life.
- A wide line-up of end configurations (female and male threads, hose barb, manifolds) enables suitability with a wide range of piping applications such as pneumatic, scientific and medical equipment.
- Also available with quick connect/disconnect Tube Fitter type.

Note: Fluid will flow out from the plug side when disconnected.  
Take necessary precaution if the fluid is water.

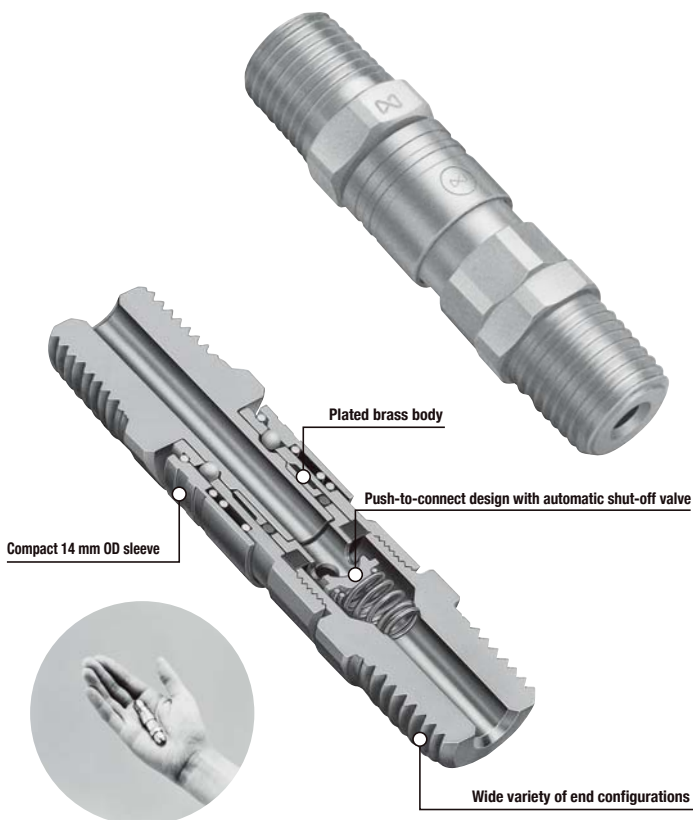

### Specifications

<b>Body material</b>	CUPLA : Brass (Chrome plated) Tube Fitter Part : Brass (Nickel plated) , Plastic			
<b>Size</b>	<b>Thread</b>	1/8", 1/4"		
	<b>Hose barb</b>	Polyamide hose: $\phi 4 \times \phi 6$ , $\phi 4.5 \times \phi 6$ Urethane hose: $\phi 4 \times \phi 6$		
	<b>Tube barb (Tube fitter) *1</b>	Polyurethane tube: Outside Dia. $\phi 6 \pm 0.1$ , $\phi 8 \pm 0.15$ Polyamide tube: Outside Dia. $\phi 6^{+0.05}_{-0.08}$ , $\phi 8^{+0.05}_{-0.1}$ Fluorine contained resin tube: Outside Dia. $\phi 6 \pm 0.07$ , $\phi 8 \pm 0.07$		
<b>Pressure unit</b>	<b>MPa</b>	<b>kgf/cm<sup>2</sup></b>	<b>bar</b>	<b>PSI</b>
<b>Working pressure</b>	1.0	10	10	145
<b>Seal material</b>	<b>Seal material</b>	<b>Mark</b>	<b>Working temperature range</b>	<b>Remarks</b>
<b>Working temperature range *2</b>	Nitrile rubber	NBR	-20°C to +80°C	Standard material

\* Above specifications apply only to CUPLA. Maximum working pressure and working temperature range may vary depending on tube materials you use with and the working temperature.

\*1: When connecting an extremely soft tube such as soft polyurethane or soft nylon, attach the insert ring specified by the tube manufacturer to the inner diameter of the tube to be connected.

\*2: The operable temperature range depends on the operating conditions.

### Maximum Tightening Torque Nm {kgf·cm}

<b>Size (Thread)</b>	<b>1/8"</b>	<b>1/4"</b>	<b>PN, SN Type</b>
<b>Torque</b>	5 {51}	9 {92}	5 {51}

### Flow Direction

Fluid flow can be bi-directional when socket and plug are connected.



### Interchangeability

Sockets and plugs can be connected regardless of end configurations.

### Minimum Cross-Sectional Area (mm<sup>2</sup>)

<b>Model</b>	<b>MS-10SM x MS-10PM</b>	<b>MS-20SM x MS-20PM</b>	<b>MS-40SN x MS-40PN</b>	<b>MS-45SN x MS-45PN</b>	<b>Tube Fitter Type for 6 mm OD tube</b>	<b>Tube Fitter Type for 8 mm OD tube</b>
<b>Minimum cross-sectional area</b>	12.5	12.5	4.9	7	12.5	12.5

### Suitability for Vacuum 53.0 kPa {400 mmHg}

<b>Socket only</b>	<b>Plug only</b>	<b>When connected</b>
-	-	Operational

### Pressure - Flow Characteristics

[Test conditions] - Fluid : Air - Tube size :  $\phi 6 \text{ mm} \times \phi 4 \text{ mm}$ ,  $\phi 8 \text{ mm} \times \phi 6 \text{ mm}$  (SMALL CUPLA with Tube Fitter)

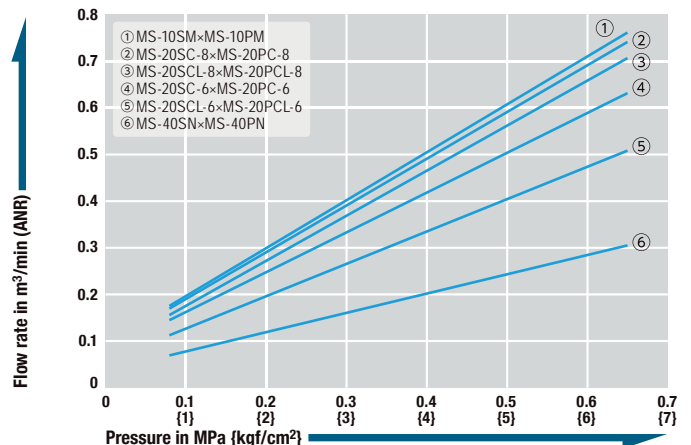



For Low Pressure

# COMPACT ZERO SPILL CUPLA

Small, high flow type for coolant piping

<p>Working pressure</p> <p>1.0 MPa (10 kgf/cm<sup>2</sup>)</p>	<p>Valve structure</p> <p>Two-way shut-off (Spill Reduction)</p>	<p>Applicable fluids</p> <p>Air Water</p>
--	--	---

For coolant piping of electronic equipment for supercomputers, data centers and other non-spill environments. Small but high flow rate for efficient cooling.

- Compact size saves space. Outer diameters of 16 mm (CZL-1SM) and 18.5 mm (CZL-2SM)
- High flow rate for efficient cooling.
- Easy operation, push-to-connect function.
- Valve structure reduces air inclusion on connection and liquid spillage when disconnecting.



Specifications				
Body material	Stainless Steel (SUS304), Nickel plated on Socket body			
Size (Thread)	1/8", 1/4"			
Pressure unit	MPa	kgf/cm <sup>2</sup>	bar	PSI
Working pressure	1.0	10	10	145
Seal material	Seal material	Mark	Working temperature range	Remarks
Working temperature range *1	Ethylene-propylene rubber	EPDM	-10°C to +100°C	Standard material

\*1: The operable temperature range depends on the operating conditions.

Maximum Tightening Torque		Nm {kgf·cm}
Size (Thread)	1/8"	1/4"
Torque	9 {92}	14 {143}

**Flow Direction**

Fluid flow can be bi-directional when socket and plug are connected.

**Interchangeability**  
Socket and plug of different sizes cannot be connected.

Minimum Cross-Sectional Area (mm <sup>2</sup> )		
Model	CZL-1SM×CZL-1PM	CZL-2SM×CZL-2PM
Min. cross-sectional area	14.9	30.2

**Suitability for Vacuum**  
Please contact us if vacuum is required for your application.

Admixture of Air on Connection (May vary depending upon the usage conditions.) (mL)		
Model	CZL-1SM×CZL-1PM	CZL-2SM×CZL-2PM
Volume of air inclusion	0.02	0.04

Volume of Spillage per Disconnection (May vary depending upon the usage conditions.) (mL)		
Model	CZL-1SM×CZL-1PM	CZL-2SM×CZL-2PM
Volume of spillage	0.015	0.023

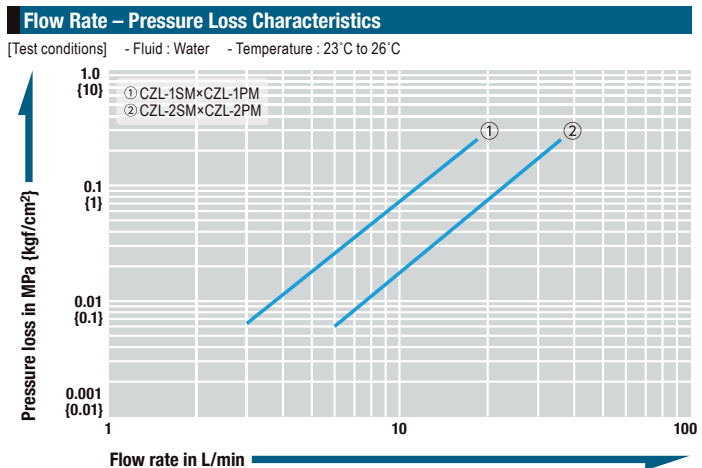



Models and Dimensions

**Plug PM type (Male thread)**

Model	Application (Thread)	Mass (g)	Dimensions (mm)				
			L	C	øD	H (WAF)	T
CZL-1PM	Rc 1/8	11	34	20	12	Hex.11	R 1/8
CZL-2PM	Rc 1/4	19	39.5	21.5	15.5	Hex.14	R 1/4

**Socket SM type (Male thread)**

Model	Application (Thread)	Mass (g)	Dimensions (mm)			
			L	øD	H (WAF)	T
CZL-1SM	Rc 1/8	38	(53)	16	Hex.13	R 1/8
CZL-2SM	Rc 1/4	49	(55.5)	18.5	Hex.16	R 1/4

Applications

Compact

Piping in tight space is possible. For compact piping.

High flow

Small but high flow rate. For efficient cooling.

COMPACT ZERO SPILL CUPLA CZL-2SM×CZL-2PM

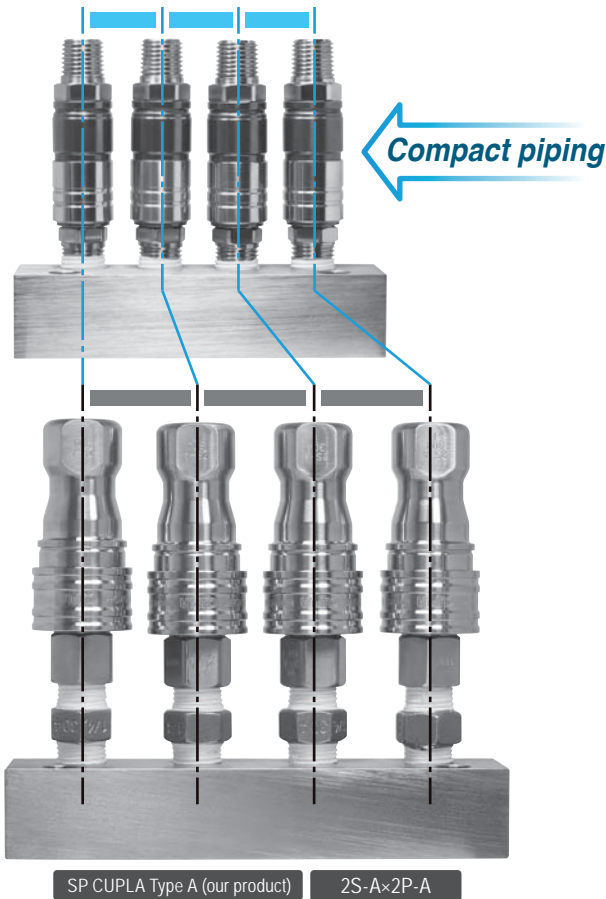

Flow Rate - Pressure Loss Characteristics

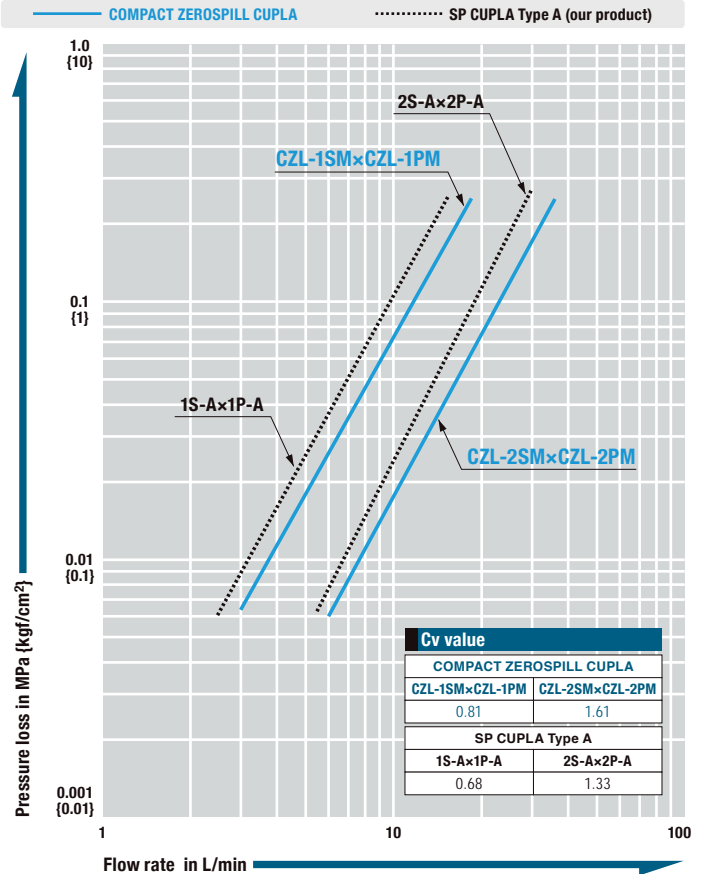

[Test conditions] - Fluid: Water - Temperature: 23°C to 26°C



For Low Pressure

# COMPACT CUPLA

Small multipurpose type for low pressure lines

<p>Working pressure</p>  <p>1.0 MPa (10 kgf/cm<sup>2</sup>)</p>	<p>Valve structure</p>  <p>Two-way shut-off</p>	<p>Applicable fluids</p>  <p>Air Water</p>
---	--	---

## Compact 17.5 mm outer diameter, yet socket and plug have built-in automatic shut-off valves.

- Both socket and plug have built-in automatic shut-off valves.
- Compact size with maximum outer diameter 17.5 mm.
- For small bore piping from temperature control piping to scientific equipment.
- Body materials in stainless steel (SUS304) or brass, excellent in corrosion resistance.
- Four types of end configuration enable suitability with a wide range of piping applications.



Specifications				
Body material		Brass, Stainless steel (SUS304)		
Size	Thread	1/8"		
	Tube barb	Polyamide tube : $\phi 4 \times \phi 6$ , $\phi 6 \times \phi 8$ Polyolefin tube : $\phi 4 \times \phi 6$ , $\phi 6 \times \phi 8$ Fluorine contained resin tube : $\phi 4 \times \phi 6$ , $\phi 6 \times \phi 8$		
Pressure unit	MPa	kgf/cm <sup>2</sup>	bar	PSI
Working pressure	1.0	10	10	145
Seal material	Seal material	Mark	Working temperature range	Remarks
Working temperature range *1	Fluoro rubber	FKM	-20°C to +180°C	Standard material
	Ethylene-propylene rubber	EPDM	-40°C to +150°C	Available on request

\*1: The operable temperature range depends on the operating conditions.

Maximum Tightening Torque		Nm {kgf·cm}	
Size (Thread)	1/8"	Tube barb	
Torque	Brass	5 (51)	5 (51)
	Stainless steel	9 (92)	7 (71)

**Flow Direction**

Fluid flow can be bi-directional when socket and plug are connected.

**Interchangeability**  
Sockets and plugs can be connected regardless of end configurations.

Minimum Cross-Sectional Area (mm <sup>2</sup> )				
Model	CO-1SM×CO-1PM	CO-1SF×CO-1PF	CO-40SN×CO-40PN	CO-60SN×CO-60PN
Minimum cross-sectional area	8.8	8.8	4.9	8.8

Suitability for Vacuum 1.3×10 <sup>-1</sup> Pa {1×10 <sup>-3</sup> mmHg}		
Socket only	Plug only	When connected
-	-	Operational

Admixture of Air on Connection <small>May vary depending upon the usage conditions.</small> (mL)	
Volume of air admixture	0.34

Volume of Spillage per Disconnection <small>May vary depending upon the usage conditions.</small> (mL)	
Volume of spillage	0.23

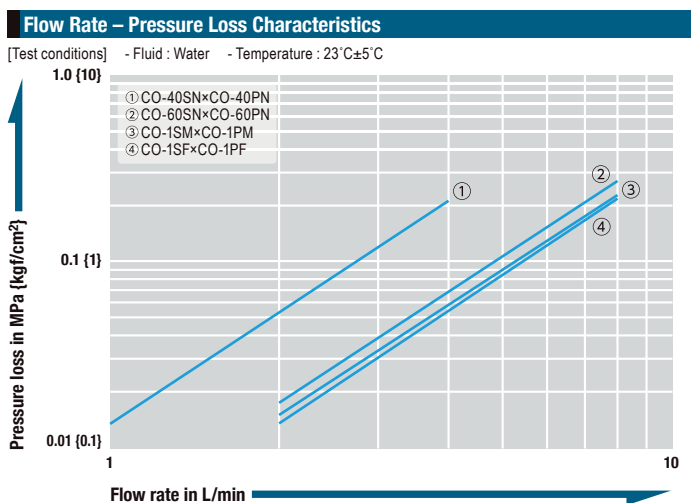

Models and Dimensions

**Plug PM type (Male thread)**

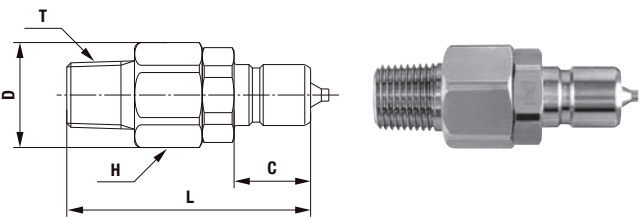

Model	Application (Thread)	Body material, Mass (g)		Dimensions (mm)				
		Brass	Stainless steel	L	C	øD	H (WAF)	T
CO-1PM	Rc 1/8	20	19	(36)	11.3	15.5	Hex.14	R 1/8

**Socket SM type (Male thread)**

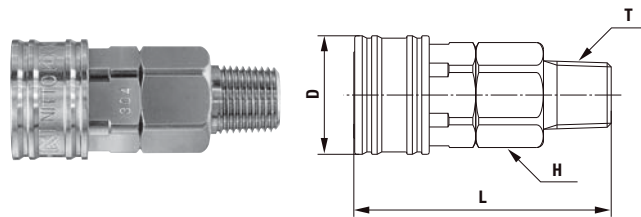

Model	Application (Thread)	Body material, Mass (g)		Dimensions (mm)			
		Brass	Stainless steel	L	øD	H (WAF)	T
CO-1SM	Rc 1/8	34	32	(38)	17.5	Hex.14	R 1/8

**Plug PF type (Female thread)**

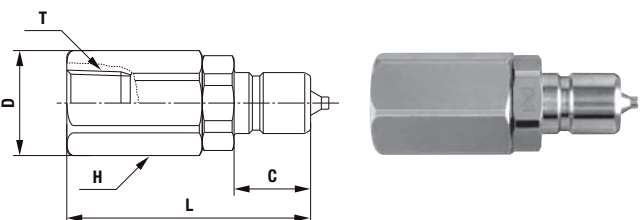

Model	Application (Thread)	Body material, Mass (g)		Dimensions (mm)				
		Brass	Stainless steel	L	C	øD	H (WAF)	T
CO-1PF	R 1/8	25	23	(36)	11.3	15.5	Hex.14	Rc 1/8

**Socket SF type (Female thread)**

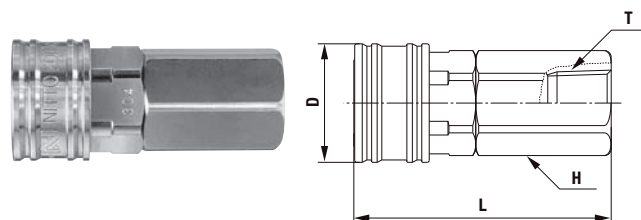

Model	Application (Thread)	Body material, Mass (g)		Dimensions (mm)			
		Brass	Stainless steel	L	øD	H (WAF)	T
CO-1SF	R 1/8	39	36	(38)	17.5	Hex.14	Rc 1/8

**Plug PN type (For connection to tube)**

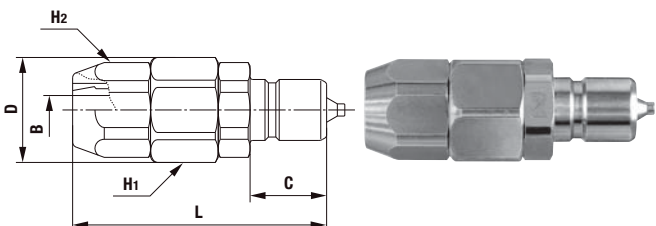

Model	Application (Tube)	Body material, Mass (g)		Dimensions (mm)					
		Brass	Stainless steel	L	C	øD	H1 (WAF)	H2 (WAF)	øB
CO-40PN	ø4×ø6	23	22	(38.5)	11.3	15.5	Hex.14	Hex.10	2.5
CO-60PN	ø6×ø8	25	24	(37.5)	11.3	15.5	Hex.14	Hex.13	4.2

**Socket SN type (For connection to tube)**

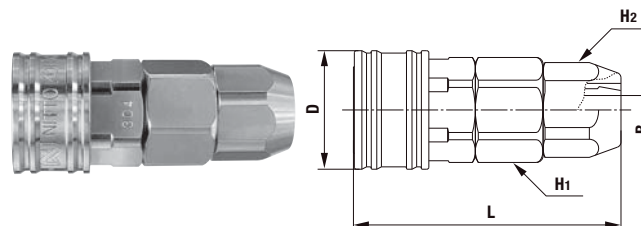

Model	Application (Tube)	Body material, Mass (g)		Dimensions (mm)					
		Brass	Stainless steel	L	øD	H1 (WAF)	H2 (WAF)	øB	
CO-40SN	ø4×ø6	38	35	(40.5)	17.5	Hex.14	Hex.10	2.5	
CO-60SN	ø6×ø8	40	37	(39.5)	17.5	Hex.14	Hex.13	4.2	

No difference in dimensions of brass and stainless steel CUPLA

Application Example

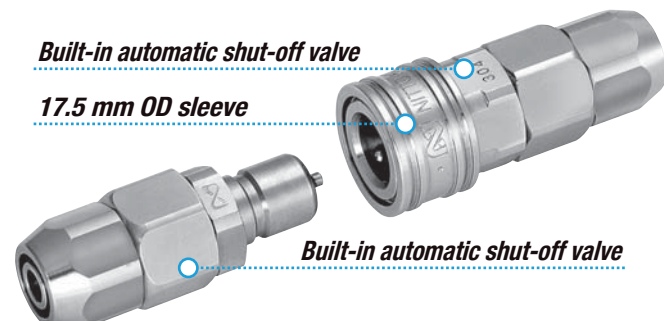
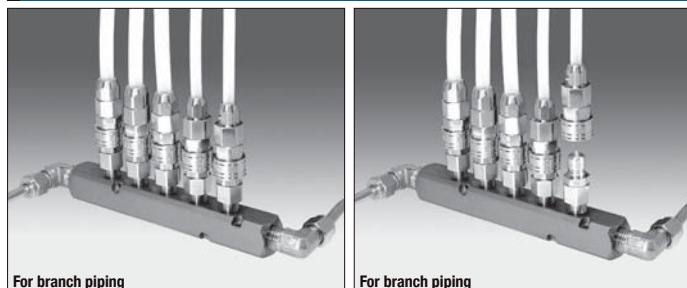

For Low Pressure

# CUBE CUPLA

Small and lightweight coupling for air supply lines.

<b>Working pressure</b>  1.0 MPa (10 kgf/cm <sup>2</sup> )	<b>Valve structure</b>  Two-way shut-off	 One-way shut-off	 Straight through	<b>Applicable fluids</b>  Air	 Water
---	--	----------------------	----------------------	-------------------------------------	-----------

Both socket and plug have built-in valve types and valveless types. Simple one action for connection or disconnection. Lightweight plastic coupling.

- In all five color variations to prevent piping mistakes.
- Ultra-lightweight, made of polyacetal resin. Compact design for space saving.
- Just push plug into socket for connection. Simply press the button on the socket for disconnection.
- Two-way shut-off type with valve on both sides and straight through type with low pressure loss are available.
- L type plug is suitable for piping in narrow spaces are available.
- Socket and plug cannot be disconnected unless two buttons on the socket are pressed simultaneously.

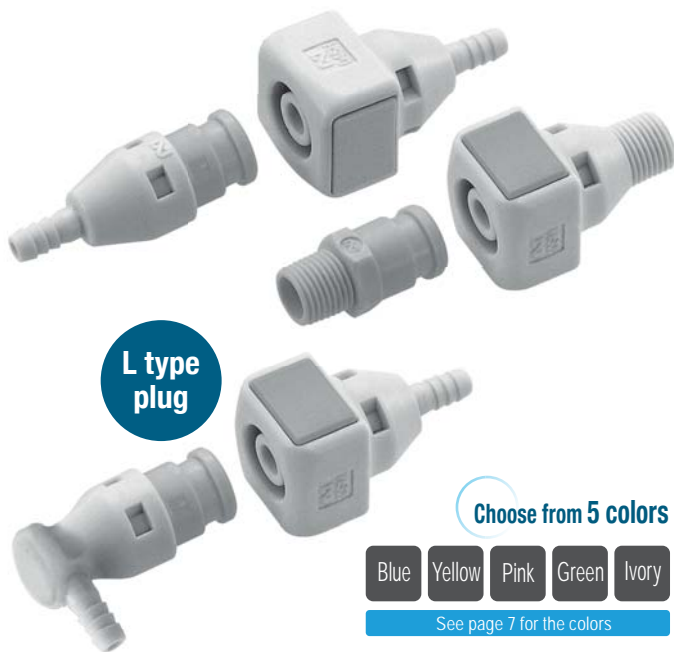

L type plug

Choose from 5 colors

Blue Yellow Pink Green Ivory

See page 7 for the colors

Push the buttons for quick disconnection

Push button for disconnection

Simple operation to push the buttons on the socket.

## Specifications

Body material	Polyacetal resin (POM)			
Size	4 mm and 6 mm ID tube, 1/8"			
Pressure unit	MPa	kgf/cm <sup>2</sup>	bar	PSI
Working pressure	1.0	10	10	145
Seal material	Seal material	Mark	Working temperature range	Remarks
Working temperature range <sup>1)</sup>	Nitrile rubber	NBR	-20°C to +60°C	Standard material

<sup>1)</sup> The operable temperature range depends on the operating conditions.

## Tightening Torque Range

Nm {kgf·cm}

Size (Thread)	R 1/8
Torque	0.9 to 1.1 (9.2 to 11)

## Flow Direction

Fluid flow can be bi-directional when socket and plug are connected.



## Interchangeability

Sockets and plugs can be connected regardless of end configurations. \*Do not use in the combination of valved sockets and valveless plugs. The valve in the socket will not open and the fluid will not flow.

## Connection capability

Select the combination of models suitable to your applications

Connection capability		Plug	
Valve		With	Without
Socket	With	 Two-way shut-off	Not connectable
	Without	 One-way shut-off	 Straight through

Note: When disconnected, the fluid from the valveless side will flow out. Take care if the fluid is water.

## Minimum Cross-Sectional Area (-VL means Valve less type) (mm<sup>2</sup>)

Socket / Plug	SPC-04SH	SPC-06SH	SPC-10SM	SPC-04SH -VL	SPC-06SH -VL	SPC-10SM -VL
SPC-04PH/PHB/PHL	5	5	5	5	5	5
SPC-06PH/PHB/PHL	5	8.6	8.6	5	8.6	8.6
SPC-10PM	5	8.6	8.6	5	8.6	8.6
SPC-04PH-VL/PHB-VL/PHL-VL	-	-	-	5	5	5
SPC-06PH-VL/PHB-VL	-	-	-	5	10.2	10.2
SPC-06PHL-VL	-	-	-	5	10.2	12.6
SPC-10PM-VL	-	-	-	5	10.2	16.6

## Suitability for Vacuum

53.0 kPa (400 mmHg)

Socket only	Plug only	When connected
-	-	Operational

## Admixture of Air on Connection (May vary depending upon the usage conditions.) (mL)

Volume of air admixture	0.60 (Built-in valve type only)
-------------------------	---------------------------------

## Volume of Spillage per Disconnection (May vary depending upon the usage conditions.) (mL)

Volume of spillage	0.51 (Built-in valve type only)
--------------------	---------------------------------

## Pressure - Flow Characteristics (The fluid flow will not differ by body color)

[Test conditions] - Fluid : Air — Solid line: Built-in valve type ..... Dotted line: Valveless type

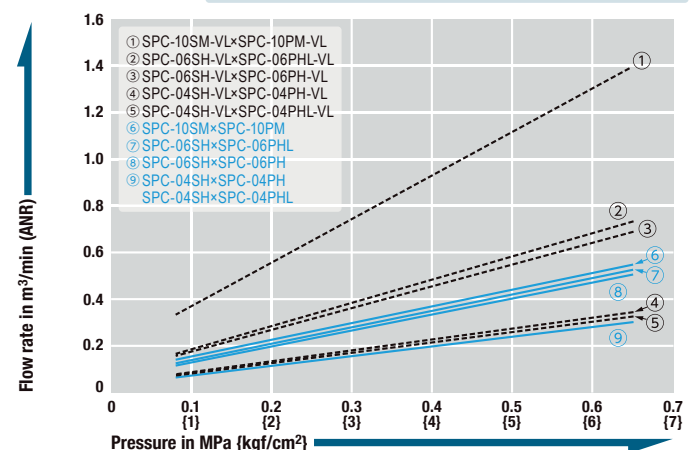

Models and Dimensions

**Plug PH type (Hose barb)**

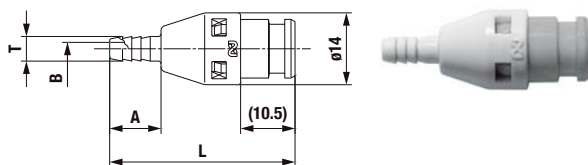

Color	Model	Application (Tube)	Built-in valve	Mass (g)	Dimensions (mm)			
					L	A	øT	øB
Ivory	SPC-04PH-IVR	4 mm ID	With	3.1	(36)	10	4.8	2.5
	SPC-04PH-VL-IVR	4 mm ID	Without	2.6	(36)	10	4.8	2.5
	SPC-06PH-IVR	6 mm ID	With	3.4	(40)	15	7	3.6
	SPC-06PH-VL-IVR	6 mm ID	Without	2.9	(40)	15	7	3.6
Blue	SPC-04PH-BLU	4 mm ID	With	3.1	(36)	10	4.8	2.5
	SPC-04PH-VL-BLU	4 mm ID	Without	2.6	(36)	10	4.8	2.5
	SPC-06PH-BLU	6 mm ID	With	3.4	(40)	15	7	3.6
	SPC-06PH-VL-BLU	6 mm ID	Without	2.9	(40)	15	7	3.6
Yellow	SPC-04PH-YEL	4 mm ID	With	3.1	(36)	10	4.8	2.5
	SPC-04PH-VL-YEL	4 mm ID	Without	2.6	(36)	10	4.8	2.5
	SPC-06PH-YEL	6 mm ID	With	3.4	(40)	15	7	3.6
	SPC-06PH-VL-YEL	6 mm ID	Without	2.9	(40)	15	7	3.6
Pink	SPC-04PH-PNK	4 mm ID	With	3.1	(36)	10	4.8	2.5
	SPC-04PH-VL-PNK	4 mm ID	Without	2.6	(36)	10	4.8	2.5
	SPC-06PH-PNK	6 mm ID	With	3.4	(40)	15	7	3.6
	SPC-06PH-VL-PNK	6 mm ID	Without	2.9	(40)	15	7	3.6
Green	SPC-04PH-GRN	4 mm ID	With	3.1	(36)	10	4.8	2.5
	SPC-04PH-VL-GRN	4 mm ID	Without	2.6	(36)	10	4.8	2.5
	SPC-06PH-GRN	6 mm ID	With	3.4	(40)	15	7	3.6
	SPC-06PH-VL-GRN	6 mm ID	Without	2.9	(40)	15	7	3.6

**Socket SH type (Hose barb)**

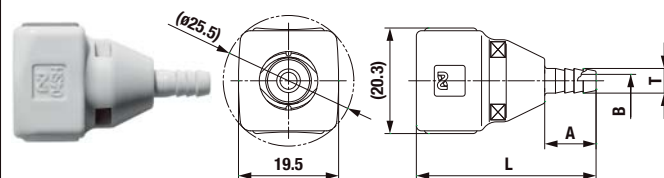

Color	Model	Application (Tube)	Built-in valve	Mass (g)	Dimensions (mm)			
					L	A	øT	øB
Ivory	SPC-04SH-IVR	4 mm ID	With	6.5	35	10	4.8	2.5
	SPC-04SH-VL-IVR	4 mm ID	Without	6.1	35	10	4.8	2.5
	SPC-06SH-IVR	6 mm ID	With	7.0	40	15	7	3.6
	SPC-06SH-VL-IVR	6 mm ID	Without	6.6	40	15	7	3.6
Blue	SPC-04SH-BLU	4 mm ID	With	6.5	35	10	4.8	2.5
	SPC-04SH-VL-BLU	4 mm ID	Without	6.1	35	10	4.8	2.5
	SPC-06SH-BLU	6 mm ID	With	7.0	40	15	7	3.6
	SPC-06SH-VL-BLU	6 mm ID	Without	6.6	40	15	7	3.6
Yellow	SPC-04SH-YEL	4 mm ID	With	6.5	35	10	4.8	2.5
	SPC-04SH-VL-YEL	4 mm ID	Without	6.1	35	10	4.8	2.5
	SPC-06SH-YEL	6 mm ID	With	7.0	40	15	7	3.6
	SPC-06SH-VL-YEL	6 mm ID	Without	6.6	40	15	7	3.6
Pink	SPC-04SH-PNK	4 mm ID	With	6.5	35	10	4.8	2.5
	SPC-04SH-VL-PNK	4 mm ID	Without	6.1	35	10	4.8	2.5
	SPC-06SH-PNK	6 mm ID	With	7.0	40	15	7	3.6
	SPC-06SH-VL-PNK	6 mm ID	Without	6.6	40	15	7	3.6
Green	SPC-04SH-GRN	4 mm ID	With	6.5	35	10	4.8	2.5
	SPC-04SH-VL-GRN	4 mm ID	Without	6.1	35	10	4.8	2.5
	SPC-06SH-GRN	6 mm ID	With	7.0	40	15	7	3.6
	SPC-06SH-VL-GRN	6 mm ID	Without	6.6	40	15	7	3.6

**Plug PM type (Male thread)**

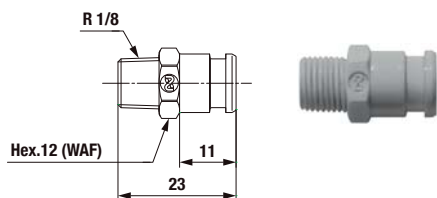

Dimensions (mm)

Color	Model	Application (Thread)	Built-in valve	Mass (g)
Ivory	SPC-10PM-IVR	Rc 1/8	With	2.0
	SPC-10PM-VL-IVR	Rc 1/8	Without	1.5
Blue	SPC-10PM-BLU	Rc 1/8	With	2.0
	SPC-10PM-VL-BLU	Rc 1/8	Without	1.5
Yellow	SPC-10PM-YEL	Rc 1/8	With	2.0
	SPC-10PM-VL-YEL	Rc 1/8	Without	1.5
Pink	SPC-10PM-PNK	Rc 1/8	With	2.0
	SPC-10PM-VL-PNK	Rc 1/8	Without	1.5
Green	SPC-10PM-GRN	Rc 1/8	With	2.0
	SPC-10PM-VL-GRN	Rc 1/8	Without	1.5

**Socket SM type (Male thread)**

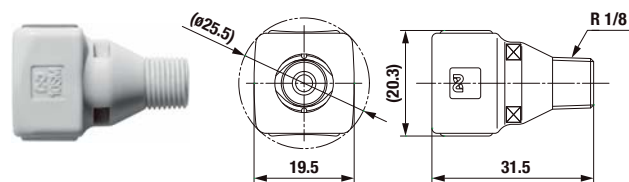

Dimensions (mm)

Color	Model	Application (Thread)	Built-in valve	Mass (g)
Ivory	SPC-10SM-IVR	Rc 1/8	With	6.8
	SPC-10SM-VL-IVR	Rc 1/8	Without	6.4
Blue	SPC-10SM-BLU	Rc 1/8	With	6.8
	SPC-10SM-VL-BLU	Rc 1/8	Without	6.4
Yellow	SPC-10SM-YEL	Rc 1/8	With	6.8
	SPC-10SM-VL-YEL	Rc 1/8	Without	6.4
Pink	SPC-10SM-PNK	Rc 1/8	With	6.8
	SPC-10SM-VL-PNK	Rc 1/8	Without	6.4
Green	SPC-10SM-GRN	Rc 1/8	With	6.8
	SPC-10SM-VL-GRN	Rc 1/8	Without	6.4



**Plug PHB Type (For panel mount)**

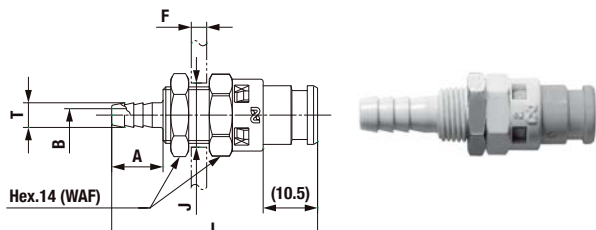

J: The diameter of the mount hole.  
F: Thickness of panel must be 5 mm or less.

Color	Model	Application (Tube)	Built-in valve	Mass (g)	Dimensions (mm)					
					L	A	øT	øB	F	øJ
Ivory	SPC-04PHB-IVR	4 mm ID	With	5.9	(40)	10	4.8	2.5	5 mm or less	11.1 <sup>+0.3</sup> <sub>0</sub>
	SPC-04PHB-VL-IVR	4 mm ID	Without	5.4	(40)	10	4.8	2.5	5 mm or less	11.1 <sup>+0.3</sup> <sub>0</sub>
	SPC-06PHB-IVR	6 mm ID	With	6.2	(45)	15	7	3.6	5 mm or less	11.1 <sup>+0.3</sup> <sub>0</sub>
	SPC-06PHB-VL-IVR	6 mm ID	Without	5.7	(45)	15	7	3.6	5 mm or less	11.1 <sup>+0.3</sup> <sub>0</sub>
Blue	SPC-04PHB-BLU	4 mm ID	With	5.9	(40)	10	4.8	2.5	5 mm or less	11.1 <sup>+0.3</sup> <sub>0</sub>
	SPC-04PHB-VL-BLU	4 mm ID	Without	5.4	(40)	10	4.8	2.5	5 mm or less	11.1 <sup>+0.3</sup> <sub>0</sub>
	SPC-06PHB-BLU	6 mm ID	With	6.2	(45)	15	7	3.6	5 mm or less	11.1 <sup>+0.3</sup> <sub>0</sub>
	SPC-06PHB-VL-BLU	6 mm ID	Without	5.7	(45)	15	7	3.6	5 mm or less	11.1 <sup>+0.3</sup> <sub>0</sub>
Yellow	SPC-04PHB-YEL	4 mm ID	With	5.9	(40)	10	4.8	2.5	5 mm or less	11.1 <sup>+0.3</sup> <sub>0</sub>
	SPC-04PHB-VL-YEL	4 mm ID	Without	5.4	(40)	10	4.8	2.5	5 mm or less	11.1 <sup>+0.3</sup> <sub>0</sub>
	SPC-06PHB-YEL	6 mm ID	With	6.2	(45)	15	7	3.6	5 mm or less	11.1 <sup>+0.3</sup> <sub>0</sub>
	SPC-06PHB-VL-YEL	6 mm ID	Without	5.7	(45)	15	7	3.6	5 mm or less	11.1 <sup>+0.3</sup> <sub>0</sub>
Pink	SPC-04PHB-PNK	4 mm ID	With	5.9	(40)	10	4.8	2.5	5 mm or less	11.1 <sup>+0.3</sup> <sub>0</sub>
	SPC-04PHB-VL-PNK	4 mm ID	Without	5.4	(40)	10	4.8	2.5	5 mm or less	11.1 <sup>+0.3</sup> <sub>0</sub>
	SPC-06PHB-PNK	6 mm ID	With	6.2	(45)	15	7	3.6	5 mm or less	11.1 <sup>+0.3</sup> <sub>0</sub>
	SPC-06PHB-VL-PNK	6 mm ID	Without	5.7	(45)	15	7	3.6	5 mm or less	11.1 <sup>+0.3</sup> <sub>0</sub>
Green	SPC-04PHB-GRN	4 mm ID	With	5.9	(40)	10	4.8	2.5	5 mm or less	11.1 <sup>+0.3</sup> <sub>0</sub>
	SPC-04PHB-VL-GRN	4 mm ID	Without	5.4	(40)	10	4.8	2.5	5 mm or less	11.1 <sup>+0.3</sup> <sub>0</sub>
	SPC-06PHB-GRN	6 mm ID	With	6.2	(45)	15	7	3.6	5 mm or less	11.1 <sup>+0.3</sup> <sub>0</sub>
	SPC-06PHB-VL-GRN	6 mm ID	Without	5.7	(45)	15	7	3.6	5 mm or less	11.1 <sup>+0.3</sup> <sub>0</sub>

**Plug PHL Type (Hose barb)**

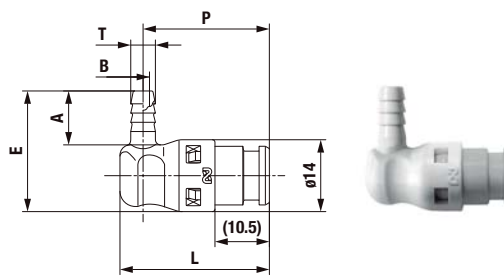

Color	Model	Application (Tube)	Built-in valve	Mass (g)	Dimensions (mm)					
					L	P	A	E	øT	øB
Ivory	SPC-04PHL-IVR	4 mm ID	With	3.5	(29)	(24.5)	10.5	23.5	4.8	2.5
	SPC-04PHL-VL-IVR	4 mm ID	Without	3	(29)	(24.5)	10.5	23.5	4.8	2.5
	SPC-06PHL-IVR	6 mm ID	With	3.9	(30.5)	(25.5)	15.5	28.5	7	4
	SPC-06PHL-VL-IVR	6 mm ID	Without	3.4	(30.5)	(25.5)	15.5	28.5	7	4
Blue	SPC-04PHL-BLU	4 mm ID	With	3.5	(29)	(24.5)	10.5	23.5	4.8	2.5
	SPC-04PHL-VL-BLU	4 mm ID	Without	3	(29)	(24.5)	10.5	23.5	4.8	2.5
	SPC-06PHL-BLU	6 mm ID	With	3.9	(30.5)	(25.5)	15.5	28.5	7	4
	SPC-06PHL-VL-BLU	6 mm ID	Without	3.4	(30.5)	(25.5)	15.5	28.5	7	4
Yellow	SPC-04PHL-YEL	4 mm ID	With	3.5	(29)	(24.5)	10.5	23.5	4.8	2.5
	SPC-04PHL-VL-YEL	4 mm ID	Without	3	(29)	(24.5)	10.5	23.5	4.8	2.5
	SPC-06PHL-YEL	6 mm ID	With	3.9	(30.5)	(25.5)	15.5	28.5	7	4
	SPC-06PHL-VL-YEL	6 mm ID	Without	3.4	(30.5)	(25.5)	15.5	28.5	7	4
Pink	SPC-04PHL-PNK	4 mm ID	With	3.5	(29)	(24.5)	10.5	23.5	4.8	2.5
	SPC-04PHL-VL-PNK	4 mm ID	Without	3	(29)	(24.5)	10.5	23.5	4.8	2.5
	SPC-06PHL-PNK	6 mm ID	With	3.9	(30.5)	(25.5)	15.5	28.5	7	4
	SPC-06PHL-VL-PNK	6 mm ID	Without	3.4	(30.5)	(25.5)	15.5	28.5	7	4
Green	SPC-04PHL-GRN	4 mm ID	With	3.5	(29)	(24.5)	10.5	23.5	4.8	2.5
	SPC-04PHL-VL-GRN	4 mm ID	Without	3	(29)	(24.5)	10.5	23.5	4.8	2.5
	SPC-06PHL-GRN	6 mm ID	With	3.9	(30.5)	(25.5)	15.5	28.5	7	4
	SPC-06PHL-VL-GRN	6 mm ID	Without	3.4	(30.5)	(25.5)	15.5	28.5	7	4

Choose from 5 colors

- Blue
- Yellow
- Pink
- Green
- Ivory

The following ■ part shown below are colored. The other plastic parts are ivory.

See page 7 for the colors

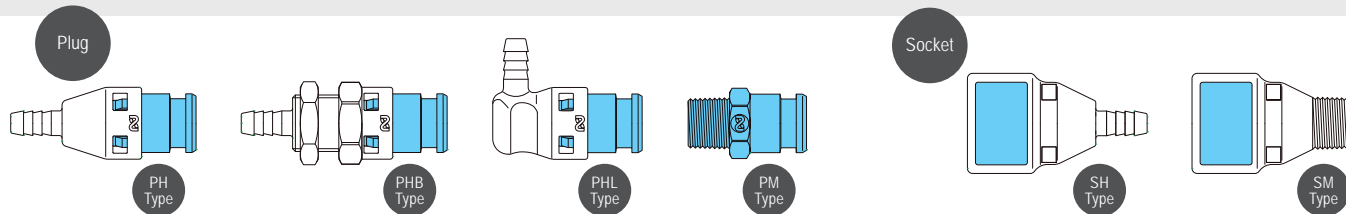

- Resin (POM) such as the main body ... Conforms to article No.3-D-2-(2)-2 and has passed both material and elution tests specified in the Food sanitation Act and the standards For Food and Food additives (Notice No. 370 of 1959 issued by the Ministry of Health and Welfare of Japan).
- O-ring (NBR) ... Conforms to article No.3-D-3-(1) and has passed both material and elution tests specified in the Food sanitation Act and the standards For Food and Food additives (Notice No. 370 of 1959 issued by the Ministry of Health and Welfare of Japan).
- Silicone type grease (NSF H1, NSF 61 registered product) is applied to the sealing material.
- Evaluation shall be made by the customer before use to determine the suitability with applications that require sanitation control.

Small size

Lightweight  
made of resin

**Compared with products of the same specification**

(Our products with similar working pressure / flow rate)

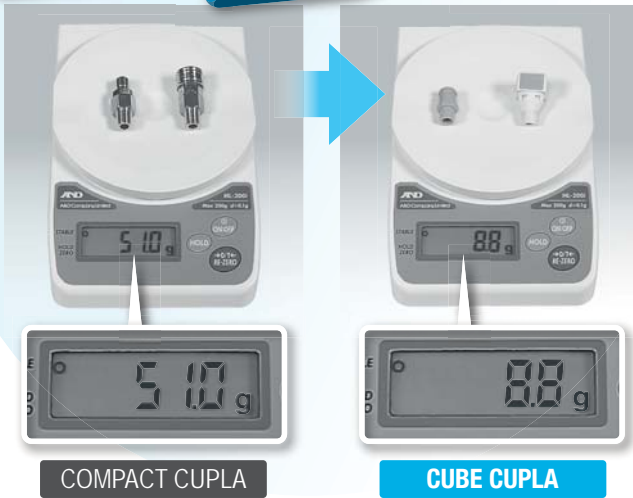

The weight is about ...

1/5

Push-to-connect  
operation

Push in

A clicking  
sound

Push button  
easy  
disconnection

Push button  
for disconnection  
2 places on the  
socket side

Just push  
the buttons

Push button  
easy  
disconnection

For Low Pressure (Air)

# SUPER CUPLA

Light, compact for air piping connections

Working pressure <b>1.0</b> 1.0 MPa (10 kgf/cm <sup>2</sup> )	Valve structure  One-way shut-off	Applicable fluid  Air
--	---	-----------------------------

## The lightweight design is suitable for power tools! Push-to-connect for easy operation.

- Lightweight design suits direct connection to power tools. Aluminum body is adopted for some models to reduce the weight.
- Just push the plug into socket for easy one hand connection.
- Available in various end configurations for a wide range of pneumatic applications.
- Model 02S20P can be connected with sockets of HI CUPLA Models 10, 17, 20, 30, 40 and 60.
- Also available with quick connect/disconnect Tube Fitter type.

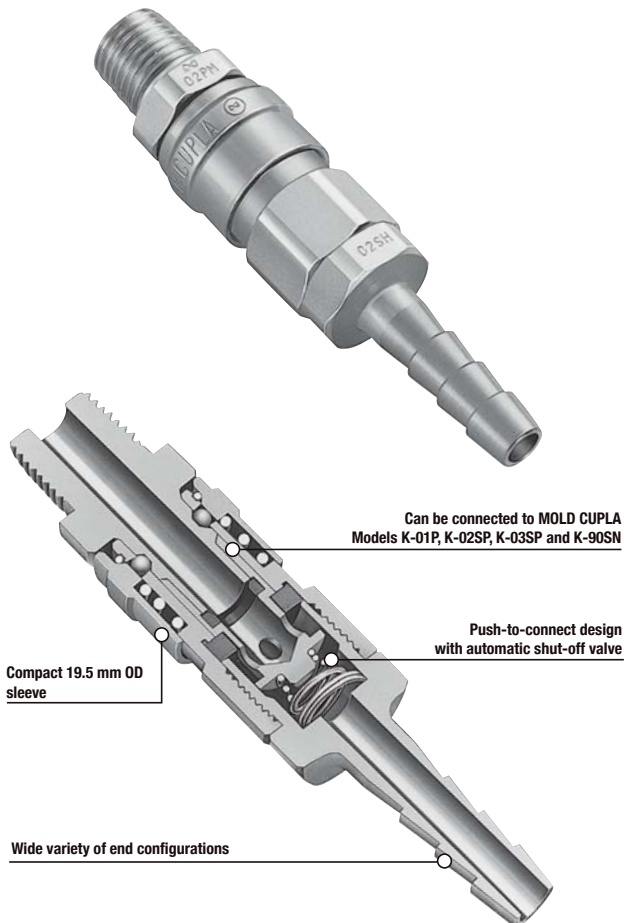

### Specifications

<b>Body material</b>		CUPLA : Steel (Chrome plated), Aluminum alloy *2 Tube Fitter Part : Brass (Nickel plated) , Plastic			
<b>Size</b>	<b>Thread</b>	1/8", 1/4"			
	<b>Hose barb</b>	1/4", Urethane hose : $\phi 5 \times \phi 8$ , $\phi 6.5 \times \phi 10$			
	<b>Tube barb (Tube fitter) *1</b>	Polyurethane tube: Outside Dia. $\phi 6 \pm 0.1$ , $\phi 8 \pm 0.15$ Polyamide tube: Outside Dia. $\phi 6^{+0.05}_{-0.08}$ , $\phi 8^{+0.05}_{-0.1}$ Fluorine contained resin tube: Outside Dia. $\phi 6 \pm 0.07$ , $\phi 8 \pm 0.07$			
<b>Pressure unit</b>	<b>MPa</b>	<b>kgf/cm<sup>2</sup></b>	<b>bar</b>	<b>PSI</b>	
<b>Working pressure</b>	1.0	10	10	145	
<b>Seal material</b>	<b>Seal material</b>	<b>Mark</b>	<b>Working temperature range</b>	<b>Remarks</b>	
<b>Working temperature range *3</b>	Nitrile rubber	NBR	-20°C to +80°C	Standard material	

- Above specifications apply only to CUPLA. Maximum working pressure and working temperature range may vary depending on tube materials you use with and the working temperature.  
\*1: When connecting an extremely soft tube such as soft polyurethane or soft nylon, attach the insert ring specified by the tube manufacturer to the inner diameter of the tube to be connected.  
\*2: Aluminum alloy is used for the body of 01SN, 02SN, 02SMF, 02SC-6, 02SC-8, 02SCL-6, 02SCL-8, 02SCB-6, 02SCB-8.  
\*3: The operable temperature range depends on the operating conditions.

### Maximum Tightening Torque

Size (Thread)	1/8"	1/4"
<b>Torque</b>	7 {71}	14 {143}

### Tightening Torque Range

PN Type, SN Type	Nm {kgf·cm}
9 to 11 {92 to 112}	

To mount on urethane hose, slide it over to the hose barb and tighten the nut until it is flush against the hose barb base. It is recommended that grease GRE-M1 is applied to the inside of the nut (threaded part and hose contact part) for easy tightening.

### Flow Direction



### Interchangeability

Sockets and plugs can be connected regardless of end configurations and sizes.  
\*Interchangeable with MOLD CUPLA.  
\*Sockets of HI CUPLA models 10, 17, 20, 30, 40, and 60 can be connected when 02S20P is used.

### Minimum Cross-Sectional Area (mm<sup>2</sup>)

Plug / Socket	01PN	02PC-6 / 02PCL-6	02PC-8 / 02PCL-8	02PH / 01PM	02PN	02PM / 02PFF
	01SN	11.3	11.3	11.3	11.3	11.3
02SC-6/02SCL-6/02SCB-6	11.3	12.5	12.5	12.5	12.5	12.5
02SC-8/02SCL-8/02SCB-8	11.3	12.5	19	19	19	19
02SH	11.3	12.5	19	19.6	19.6	19.6
02SN	11.3	12.5	19	19.6	22	22
02SM/02SF/02SMF	11.3	12.5	19	19.6	22	28.2
02S20P	11.3	12.5	19	19.6	22	28.2

### Suitability for Vacuum

Not suitable for vacuum application in either connected or disconnected condition.

### Pressure - Flow Characteristics

[Test conditions] - Fluid : Air - Tube size :  $\phi 6 \text{ mm} \times \phi 4 \text{ mm}$ ,  $\phi 8 \text{ mm} \times \phi 6 \text{ mm}$  (SUPER CUPLA with Tube Fitter)

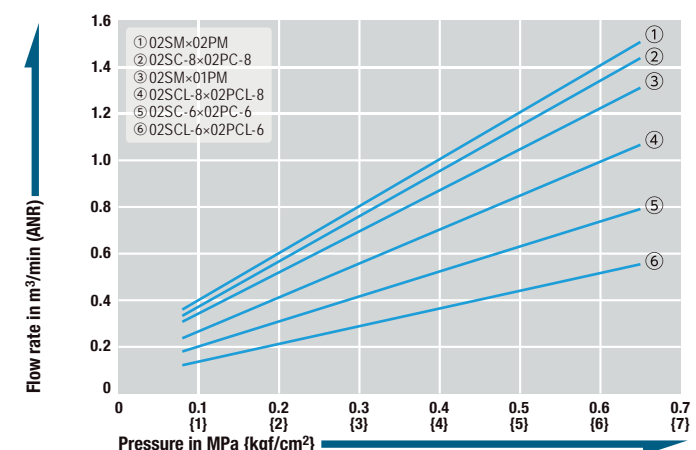

Models and Dimensions

**Plug** O2PH type (Hose barb)

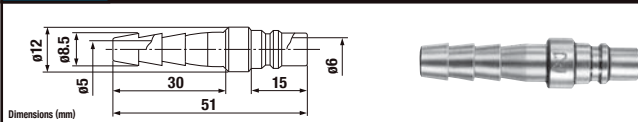

Model	Application (Hose)	Mass (g)
O2PH	1/4"	16

**Plug** PN type (For connection to urethane hose)

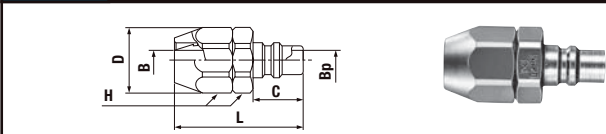

Model	Application (Hose)	Mass (g)	Dimensions (mm)					
			L	C	øD	H(WAF)	øBp	øB
O1PN	ø5 mm×ø8 mm	35.9	(38.5)	15	18.5	Hex.17	6	3.8
O2PN	ø6.5 mm×ø10 mm	35.3	(38.5)	15	18.5	Hex.17	6	5.3

**Plug** PM type (Male thread)

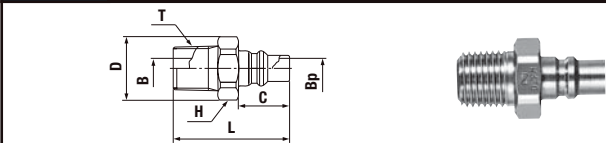

Model	Application (Thread)	Mass (g)	Dimensions (mm)						
			L	C	øD	H(WAF)	T	øBp	øB
O1PM	Rc 1/8	12	31	15	-	Hex.12	R 1/8	6	5
O2PM	Rc 1/4	22.7	34	15	18.5	Hex.17	R 1/4	6	6

**Plug** O2PFF type (Parallel female thread)

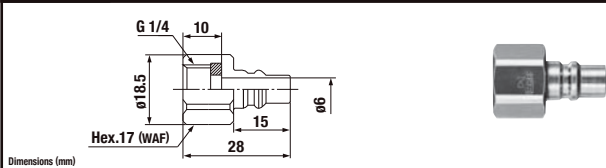

Model	Application (Thread)	Mass (g)
O2PFF	G 1/4	17.7

**Plug/Socket** Model O2S20P (Conversion model to connect HI CUPLA socket)

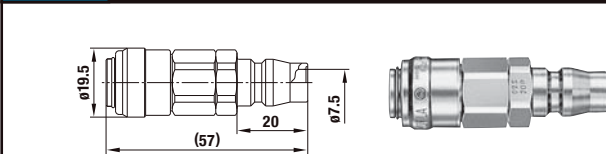

Model	Application	Mass (g)
O2S20P	HI CUPLA (Socket)	58

**Plug** PC type (With Tube Fitter)

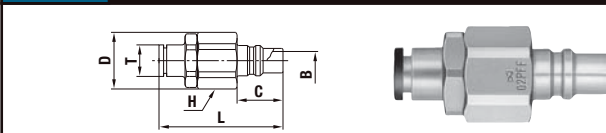

Model	Application (Tube)	Mass (g)	Dimensions (mm)						
			L	C	øD	E	H(WAF)	øT	øB
O2PC-6	6 mm OD	28.5	(40.5)	15	18.5	18.5	Hex.17	10.3	6
O2PC-8	8 mm OD	33	(47.5)	15	18.5	18.5	Hex.17	13.5	6

**Plug** PCL type (With L-shaped Tube Fitter)

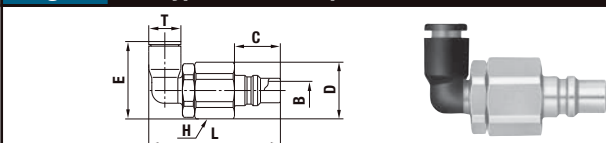

Model	Application (Tube)	Mass (g)	Dimensions (mm)						
			L	C	øD	E	H(WAF)	øT	øB
O2PCL-6	6 mm OD	29.5	(43)	15	18.5	(25.3)	Hex.17	10.5	6
O2PCL-8	8 mm OD	34.5	(46.5)	15	18.5	(32.3)	Hex.17	13.5	6

**Socket** O2SH type (Hose barb)

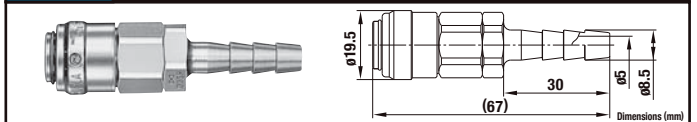

Model	Application (Hose)	Mass (g)
O2SH	1/4"	56

**Socket** SN type (For connection to urethane hose)

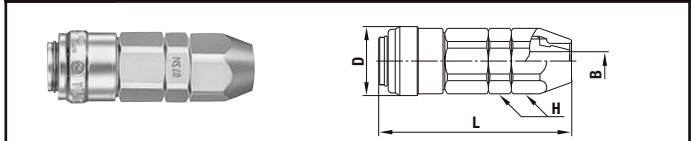

Model	Application (Hose)	Mass (g)	Dimensions (mm)			
			L	øD	H(WAF)	øB
O1SN	ø5 mm×ø8 mm	45.8	(54.5)	19.5	Hex.17	3.8
O2SN	ø6.5 mm×ø10 mm	44.4	(54.5)	19.5	Hex.17	5.3

**Socket** SM type (Male thread)

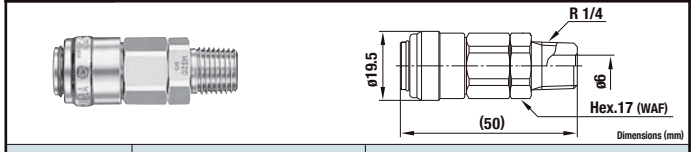

Model	Application (Thread)	Mass (g)
O2SM	Rc 1/4	57

**Socket** O2SF type (Female thread)

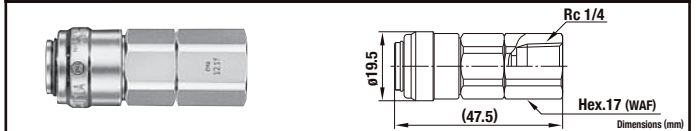

Model	Application (Thread)	Mass (g)
O2SF	R 1/4	56.4

**Socket** O2SMF type (Parallel male thread)

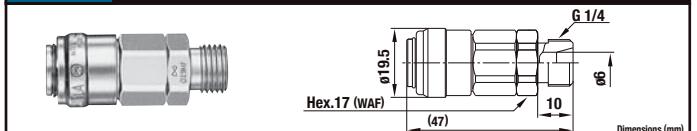

Model	Application (Thread)	Mass (g)
O2SMF	G 1/4	27

**Socket** SC type (With Tube Fitter)

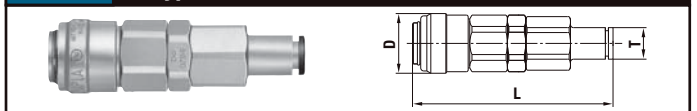

Model	Application (Tube)	Mass (g)	Dimensions (mm)		
			L	øD	øT
O2SC-6	6 mm OD	46	(65.5)	19.5	10.5
O2SC-8	8 mm OD	50.5	(70)	19.5	13.5

**Socket** SCL type (With L-shaped Tube Fitter)

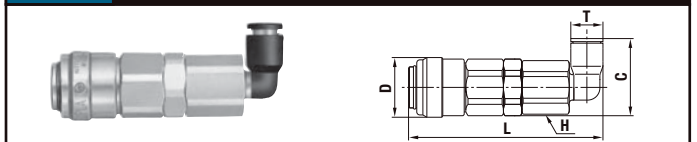

Model	Application (Tube)	Mass (g)	Dimensions (mm)				
			L	øD	H(WAF)	C	øT
O2SCL-6	6 mm OD	47.5	(63.5)	19.5	Hex.16	(25.7)	10.3
O2SCL-8	8 mm OD	49.5	(67.7)	19.5	Hex.16	(32.8)	13.5

**Socket** SCB type (With Tube Fitter for panel mounting)

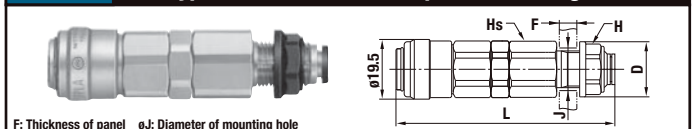

Model	Application (Tube)	Mass (g)	Dimensions (mm)					
			L	øD	Hs(WAF)	H(WAF)	F	øJ
O2SCB-6	6 mm OD	58.5	(71.5)	18	Hex.17	Hex.15	7 or less	12.5 <sup>+0.3</sup>
O2SCB-8	8 mm OD	60.4	(72)	21	Hex.17	Hex.18	8 or less	15.5 <sup>+0.3</sup>

F: Thickness of panel øJ: Diameter of mounting hole



For Low Pressure

# HI CUPLA

Universal purpose couplings for air lines

Working pressure

Valve structure

Applicable fluids (Steel applies to air only)

1.5 MPa (15 kgf/cm<sup>2</sup>)    1.0 MPa (10 kgf/cm<sup>2</sup>)

One-way shut-off

Air    Water

From factory air line to pneumatic tool connection, available in various body materials, sizes and end configurations. Excellent durability.

- An excellent general purpose coupling for connecting factory air supply to pneumatic tools.
- Steel coupling is suitable for air. Brass or stainless steel is suitable for water. Note that fluid will come out from the plug when disconnected.
- Critical structural parts of steel models are heat-treated for increased strength giving greater durability and resistance to wear.
- Available in various body materials, sizes and end configurations applicable to a wide range of applications.

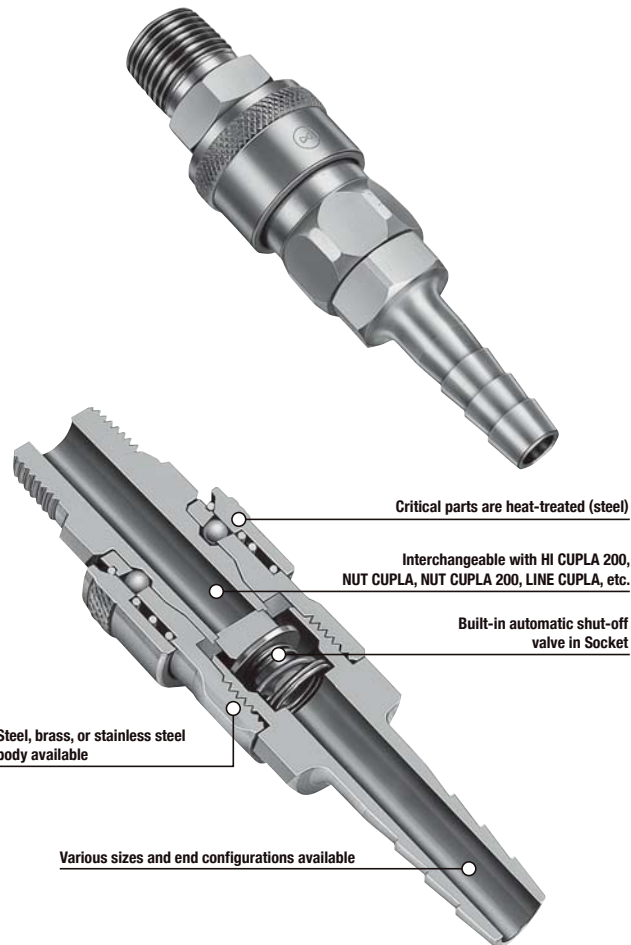

### Suitability for Vacuum

Not suitable for vacuum application in either connected or disconnected condition.

### Specifications

Body material		Steel (Chrome plated)	Brass	Stainless steel (SUS304)
Size	Thread and hose barb	Thread and hose barb 1/8" to 1", 1/4" to 1" hose		
	Tube barb (Tube fitter) <sup>1</sup>	Polyurethane tube: Outer dia. $\phi 6 \pm 0.1$ , $\phi 8 \pm 0.15$ , $\phi 10 \pm 0.15$ Polyamide tube: Outer dia. $\phi 6^{+0.05}_{-0.08}$ , $\phi 8^{+0.05}_{-0.1}$ , $\phi 10^{+0.05}_{-0.1}$ Fluorine contained resin tube: Outer dia. $\phi 6 \pm 0.07$ , $\phi 8 \pm 0.07$ , $\phi 10 \pm 0.07$		
Working pressure	MPa	1.5	1.0	1.5
	kgf/cm <sup>2</sup>	15	10	15
	bar	15	10	15
	PSI	218	145	218
Seal material		Nitrile rubber	Fluoro rubber	
Working temperature range <sup>2</sup>		-20°C to +80°C	-20°C to +180°C	Standard material
		Mark	NBR	FKM

<sup>1</sup> Above specifications apply only to CUPLA. Maximum working pressure and working temperature range may vary depending on tube materials you use with and the working temperature.

<sup>2</sup> When connecting an extremely soft tube such as soft polyurethane or soft nylon, attach the insert ring specified by the tube manufacturer to the inner diameter of the tube to be connected.

<sup>3</sup> The operable temperature range depends on the operating conditions.

### Maximum Tightening Torque

Size (Thread)		1/8"	1/4"	3/8"	1/2"	3/4"	1"
Torque	Steel	7 {71}	14 {143}	22 {224}	60 {612}	100 {1020}	120 {1224}
	Brass	5 {51}	9 {92}	11 {112}	30 {306}	50 {510}	65 {663}
	Stainless steel	-	14 {143}	22 {224}	60 {612}	100 {1020}	120 {1224}

### Flow Direction



### Interchangeability

- 1 Sockets and plugs of models 10, 17, 20, 30, 40, and 60 can be connected with each other regardless of end configurations.
- 2 Sockets and plugs of models 400, 600, and 800 can be connected with each other regardless of end configurations. 1 and 2 can not be connected across each group.
- 3 Interchangeable with each models of NUT CUPLA series and HI CUPLA series. Please see page 21 for "HI CUPLA Series Interchangeability".

### Minimum Cross-Sectional Area

(mm<sup>2</sup>)

10, 17, 20, 30, 40, 60 type		17PH	20PH	30PH	40PH	10PM	20PM	30PM	40PM	20PF	30PF	40PF
Socket	Plug											
10SM		16	20	20	20	13	20	20	20	20	20	20
17SH		16	16	16	16	13	16	16	16	16	16	16
20SH		16	20	20	20	13	20	20	20	20	20	20
20SM, SF		16	20	33	33	13	33	33	33	33	33	33
30SH		16	20	33	33	13	33	33	33	33	33	33
30SM, SF		16	20	33	33	13	33	33	33	33	33	33
40SH		16	20	33	33	13	33	33	33	33	33	33
40SM, SF		16	20	33	33	13	33	33	33	33	33	33
60SM		16	20	33	33	13	33	33	33	33	33	33

### 400, 600, 800 type

400, 600, 800 type		400PH	600PH	800PH	400PM	600PM	800PM	400PF	600PF	800PF
Socket	Plug									
400SH		64	64	64	64	64	64	64	64	64
400SM, SF		64	94	94	94	94	94	94	94	94
600SH		64	94	94	94	94	94	94	94	94
600SM, SF		64	94	94	94	94	94	94	94	94
800SH		64	94	94	94	94	94	94	94	94
800SM, SF		64	94	94	94	94	94	94	94	94

### Pressure - Flow Characteristics

[Test conditions] - Fluid : Air

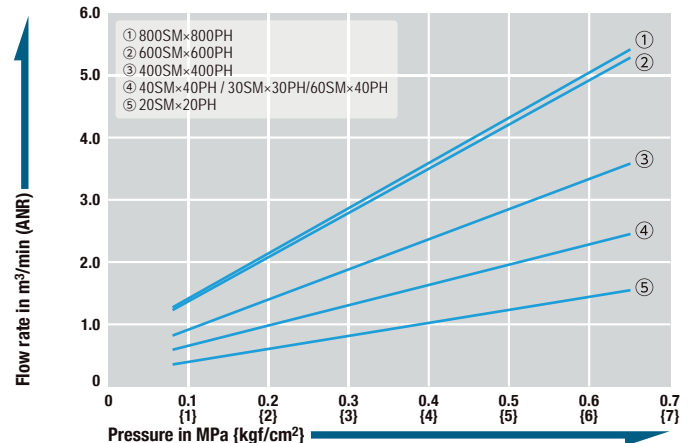



Models and Dimensions

**Plug PH type (Hose barb)**

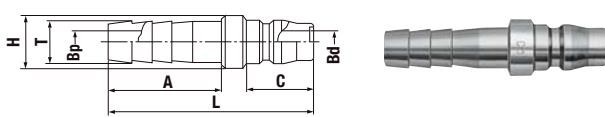

Model	Application (Hose)	Body material • Mass (g)			Dimensions (mm)						
		Steel	Brass	Stainless steel	L	øH	A	C	øT	øBp	øBd
17PH	1/4"	24	-	-	54	16	27	20	7.2	4.5	7.5
20PH	1/4"	28	31	27	57	16	30	20	9	5	7.5
30PH	3/8"	32	34	33	61	16	34	20	11.3	7.5	7.5
40PH	1/2"	59	64	60	63	20	36	20	15	9	7.5
400PH	1/2"	65	71	66	66	22	36	23	15	9	13
600PH	3/4"	123	130	124	77	30	45	23	21	13	13
800PH	1"	151	161	151	85	34	54	23	27	20	13

**Socket SH type (Hose barb)**

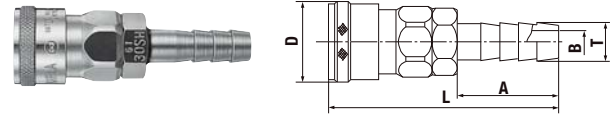

Model	Application (Hose)	Body material • Mass (g)			Dimensions (mm)				
		Steel	Brass	Stainless steel	L	øD	A	øT	øB
17SH	1/4"	99	-	-	(69.5)	(26.5)	27	7.2	4.5
20SH	1/4"	99	105	97	(72.5)	(26.5) <sup>+1</sup>	30	9	5
30SH	3/8"	102	107	100	(76.5)	(26.5) <sup>+1</sup>	34	11.3	7.5
40SH	1/2"	115	122	113	(78.5)	(26.5) <sup>+1</sup>	36	15	9
400SH	1/2"	220	235	230	(83)	35	36	15	9
600SH	3/4"	243	262	242	(92)	35	45	21	14
800SH	1"	327	350	325	(102)	35	55	27	16

**Plug PM type (Male thread)**

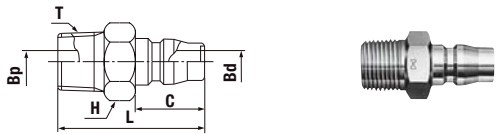

Model	Application (Thread)	Body material • Mass (g)			Dimensions (mm)					
		Steel	Brass	Stainless steel	L	H(WAF)	C	T	øBp	øBd
10PM	Rc 1/8	22	24	-	37	Hex.14	20	R 1/8	4	7.5
20PM	Rc 1/4	25	27	26	41	Hex.14	20	R 1/4	7.5	7.5
30PM	Rc 3/8	40	43	41	42	Hex.19 <sup>-3</sup>	20	R 3/8	7.5	7.5
40PM	Rc 1/2	60	65	60	46	Hex.22	20	R 1/2	12	7.5
400PM	Rc 1/2	70	73	69	50	Hex.22	23	R 1/2	13	13
600PM	Rc 3/4	113	121	114	55	Hex.32	23	R 3/4	19	13
800PM	Rc 1	182	196	183	63	Hex.35	23	R 1	22	13

**Socket SM type (Male thread)**

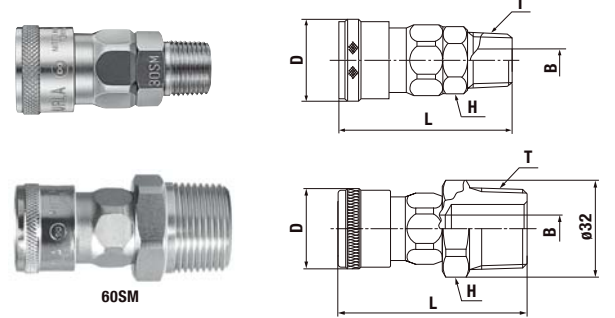

Model	Application (Thread)	Body material • Mass (g)			Dimensions (mm)				
		Steel	Brass	Stainless steel	L	øD	H(WAF)	T	øB
10SM	Rc 1/8	97	-	-	(52.5)	(26.5)	Hex.19	R 1/8	5
20SM	Rc 1/4	97	103	96	(55.5)	(26.5) <sup>+1</sup>	Hex.19	R 1/4	7
30SM	Rc 3/8	104	108	100	(56.5)	(26.5) <sup>+1</sup>	Hex.19	R 3/8	8 <sup>-4</sup>
40SM	Rc 1/2	127	135	126	(59.5)	(26.5) <sup>+1</sup>	Hex.23 <sup>-2</sup>	R 1/2	9
60SM	Rc 3/4	158	-	-	(62.5)	(26.5)	Hex.29	R 3/4	9
400SM	Rc 1/2	210	224	212	(63)	35	Hex.29	R 1/2	13
600SM	Rc 3/4	242	259	243	(67)	35	Hex.32	R 3/4	16
800SM	Rc 1	329	353	328	(72)	35	Hex.36	R 1	16

**Plug PF type (Female thread)**

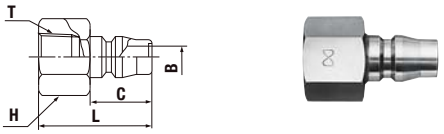

Model	Application (Thread)	Body material • Mass (g)			Dimensions (mm)				
		Steel	Brass	Stainless steel	L	H(WAF)	C	T	øB
20PF	R 1/4	28	31	29	36	Hex.17	20	Rc 1/4	7.5
30PF	R 3/8	35	41	38	37	Hex.21	20	Rc 3/8	7.5
40PF	R 1/2	69	76	70	38	Hex.29	20	Rc 1/2	7.5
400PF	R 1/2	82	86	81	41	Hex.29	23	Rc 1/2	13
600PF	R 3/4	115	124	115	45	Hex.35	23	Rc 3/4	13
800PF	R 1	189	207	190	54	Hex.41	23	Rc 1	13

**Socket SF type (Female thread)**

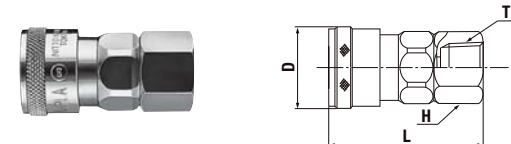

Model	Application (Thread)	Body material • Mass (g)			Dimensions (mm)			
		Steel	Brass	Stainless steel	L	øD	H(WAF)	T
20SF	R 1/4	97	101	94	(49.5)	(26.5) <sup>-1</sup>	Hex.19	Rc 1/4
30SF	R 3/8	98	103	95	(50.5)	(26.5) <sup>-1</sup>	Hex.21	Rc 3/8
40SF	R 1/2	136	146	138	(52.5)	(26.5) <sup>-1</sup>	Hex.29	Rc 1/2
400SF	R 1/2	216	233	215	(57)	35	Hex.29	Rc 1/2
600SF	R 3/4	259	277	257	(61)	35	Hex.35	Rc 3/4
800SF	R 1	329	361	327	(68)	35	Hex.41	Rc 1

**Plug PFF type (Parallel female thread)**

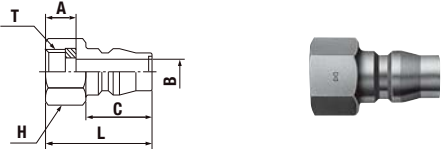

Model	Application (Thread)	Body material • Mass (g)			Dimensions (mm)					
		Steel	Brass	Stainless steel	L	H(WAF)	A	C	T	øB
20PFF	G 1/4	23	-	-	32	Hex.17	9	20	G 1/4	7.5

**Plug PC type (Tube Fitter)**

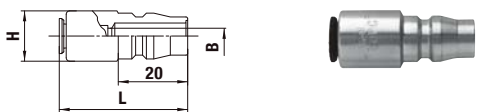

Model	Application (Tube)	Mass (g)	Dimensions (mm)		
			L	øH	øB
60PC	For 6 mm OD tube	25	(37)	14.5	4.5
80PC	For 8 mm OD tube	30	(41)	16.5	6.5
100PC	For 10 mm OD tube	43	(45)	19.5	7.5

• Above pictures are plugs and sockets of steel 20, 30 and 40 models.  
 \*1 : D = 25.4 for brass and stainless steel models.  
 \*2 : H = Hex. 22 for brass and stainless steel models.  
 \*3 : H = Hex. 17 for brass and stainless steel models.  
 \*4 : B = 9 for brass and stainless steel models.

**Plug and tube can be connected in one push-to-connect operation.**

Just push the tube into CUPLA and then it is locked.  
 Polyurethane, Polyamide and Fluorine contained resin tubes.

**PC type (Tube Fitter)**

For Low Pressure

# HI CUPLA BL

Universal purpose couplings with separation prevention mechanism for air lines

Working pressure **1.5** MPa (15 kgf/cm<sup>2</sup>)

Valve structure: One-way shut-off

Applicable fluids (Steel applies to air only): Air, Water

## Separation prevention mechanism is easily locked by turning the sleeve after connection.

- Separation prevention mechanism prevents accidental disconnection.
- An excellent general purpose coupling for connecting factory air supply to pneumatic tools.
- Steel coupling is suitable for air. Stainless steel is suitable for water.
- Note that fluid will come out from the plug when disconnected.
- Critical structural parts made of steel are heat-treated for increased strength giving greater durability and resistance to wear.
- Various body materials, sizes, and end configurations are available.
- SN-BL type for connection to urethane hose requires no hose clamp.



Specifications				
Body material		Steel (Chrome plated)	Stainless steel (SUS304)	
Size	Thread and hose barb	1/4", 3/8", 1/2"		
	SN Type for urethane hose	For ø6.5×ø10 mm hose		
		For ø8×ø12 mm hose For ø8.5×ø12.5 mm hose		
Pressure unit	MPa	kgf/cm <sup>2</sup>	bar	PSI
Working pressure	1.5	15	15	218
Seal material	Seal material	Mark	Working temperature range	Remarks
Working temperature range *1	Nitrile rubber	NBR	-20 °C to +80 °C	Standard material

\*1: Working temperature range of SN-BL type is -20 °C to +60 °C.  
The operable temperature range depends on the operating conditions.

Maximum Tightening Torque		Nm {kgf·cm}		
Size (Thread)		1/4"	3/8"	1/2"
Torque	Steel	14 {143}	22 {224}	60 {612}
	Stainless steel	14 {143}	22 {224}	60 {612}

Tightening Torque Range		Nm {kgf·cm}		
SN Type for urethane hose				
9 to 11 {92 to 112}				

To mount on urethane hose, slide it over to the hose barb and tighten the nut until it is flush against the hose barb base. It is recommended that grease GRE-M1 is applied to the inside of the nut (threaded part and hose contact part) for easy tightening.

### Flow Direction

Fluid must run from socket to plug.

### Interchangeability

Interchangeable with plugs of HI CUPLA models 10, 17, 20, 30 and 40. Interchangeable with each models of NUT CUPLA series and HI CUPLA series (except models 400, 600, and 800). Please see page 21 for "HI CUPLA Series Interchangeability".

Minimum Cross-Sectional Area		(mm <sup>2</sup> )										
Socket	Plug	17PH	20PH	30PH	40PH	10PM	20PM	30PM	40PM	20PF	30PF	40PF
20SH-BL		16	20	20	20	13	20	20	20	20	20	20
20SM-BL		16	20	33	33	13	33	33	33	33	33	33
20SF-BL		16	20	33	33	13	33	33	33	33	33	33
30SH-BL		16	20	33	33	13	33	33	33	33	33	33
30SM-BL		16	20	33	33	13	33	33	33	33	33	33
30SF-BL		16	20	33	33	13	33	33	33	33	33	33
40SH-BL		16	20	33	33	13	33	33	33	33	33	33
40SM-BL		16	20	33	33	13	33	33	33	33	33	33
40SF-BL		16	20	33	33	13	33	33	33	33	33	33
65SN-BL		16	20	22	22	13	22	22	22	22	22	22
80SN-BL		16	20	33	33	13	33	33	33	33	33	33
85SN-BL		16	20	33	33	13	33	33	33	33	33	33

### Suitability for Vacuum

Not suitable for vacuum application in either connected or disconnected condition.

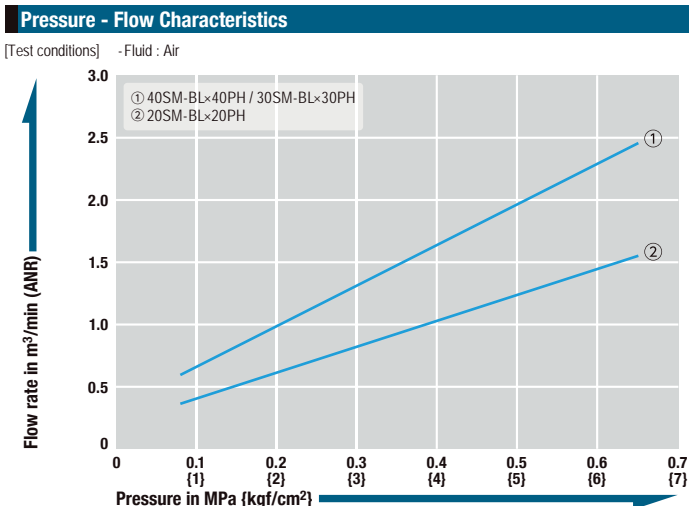

Models and Dimensions

Steel

Socket SH-BL type (Hose barb)

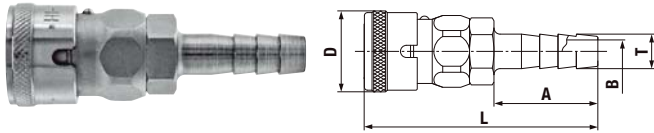

Model	Application (Hose)	Mass (g)	Dimensions (mm)				
			L	øD	A	øT	øB
20SH-BL	1/4"	103	(72.5)	(26.5)	30	9	5
30SH-BL	3/8"	106	(76.5)	(26.5)	34	11.3	7.5
40SH-BL	1/2"	118	(78.5)	(26.5)	36	15	9

Socket SM-BL type (Male thread)

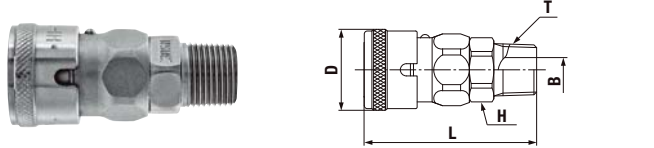

Model	Application (Thread)	Mass (g)	Dimensions (mm)				
			L	øD	H(WAF)	T	øB
20SM-BL	Rc 1/4	101	(55.5)	(26.5)	Hex.19	R 1/4	7
30SM-BL	Rc 3/8	108	(56.5)	(26.5)	Hex.19	R 3/8	8
40SM-BL	Rc 1/2	131	(59.5)	(26.5)	Hex.23	R 1/2	9

Socket SF-BL type (Female thread)

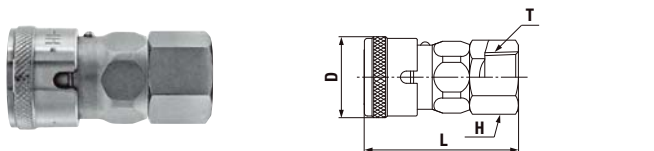

Model	Application (Thread)	Mass (g)	Dimensions (mm)			
			L	øD	H(WAF)	T
20SF-BL	R 1/4	95	(49.5)	(26.5)	Hex.19	Rc 1/4
30SF-BL	R 3/8	103	(50.5)	(26.5)	Hex.21	Rc 3/8
40SF-BL	R 1/2	139	(52.5)	(26.5)	Hex.29	Rc 1/2

Socket SN-BL type (For urethane hose connection)

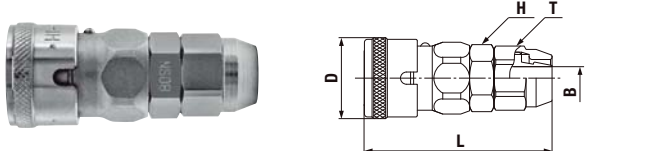

Model	Application (Hose)	Mass (g)	Dimensions (mm)				
			L	øD	øB	H(WAF)	T(WAF)
65SN-BL	ø6.5×ø10	115	(59.5)	(26.5)	5.3	Hex.19	Hex.17
80SN-BL	ø8×ø12	120	(61.5)	(26.5)	7.5	Hex.19	Hex.19
85SN-BL	ø8.5×ø12.5	120	(61.5)	(26.5)	7.5	Hex.19	Hex.19

\* Above pictures are sockets of 30 and 80 models.



Stainless steel

Socket SH-BL type (Hose barb)

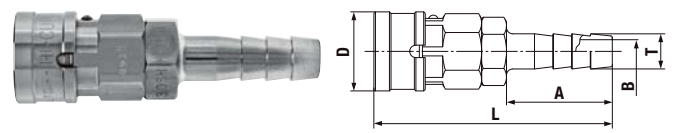

Model	Application (Hose)	Mass (g)	Dimensions (mm)				
			L	øD	A	øT	øB
20SH-BL	1/4"	100	(72.5)	25.4	30	9	5
30SH-BL	3/8"	101	(76.5)	25.4	34	11.3	7.5
40SH-BL	1/2"	118	(78.5)	25.4	36	15	9

Socket SM-BL type (Male thread)

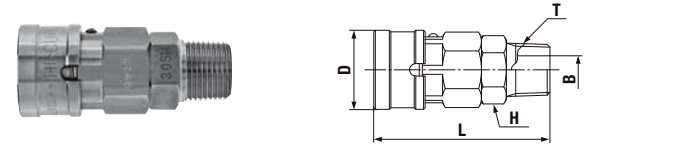

Model	Application (Thread)	Mass (g)	Dimensions (mm)				
			L	øD	H(WAF)	T	øB
20SM-BL	Rc 1/4	96	(55.5)	25.4	Hex.19	R 1/4	7
30SM-BL	Rc 3/8	105	(56.5)	25.4	Hex.19	R 3/8	9
40SM-BL	Rc 1/2	120	(59.5)	25.4	Hex.22	R 1/2	9

Socket SF-BL type (Female thread)

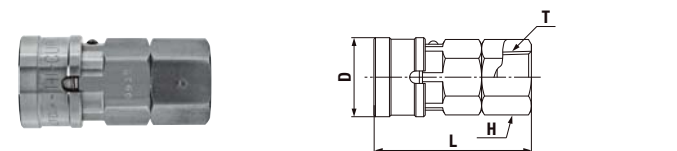

Model	Application (Thread)	Mass (g)	Dimensions (mm)			
			L	øD	H(WAF)	T
20SF-BL	R 1/4	98	(49.5)	25.4	Hex.19	Rc 1/4
30SF-BL	R 3/8	99	(50.5)	25.4	Hex.21	Rc 3/8
40SF-BL	R 1/2	138	(52.5)	25.4	Hex.29	Rc 1/2

**Unlocked**

Align the cutout in the sleeve with the ball stopper, and pull the sleeve to connect the plug.

The stopper is marked with blue for visual understanding.

**Locking the sleeve**

Without alignment of the cutout with the ball stopper disconnection cannot be made.

**Accidental disconnection is prevented.**

Align the cutout in the sleeve with the ball stopper, and pull the sleeve for disconnection.

For Low Pressure (Air)

# HI CUPLA 200

Push-to-connect type for air lines

Working pressure



Valve structure



Applicable fluid



**Simple and secure push-to-connect type! Big flow rate! End-face seal design. Gives excellent handling touch.**

- Just push the plug into the socket for simple and secure connection. This reduces connection time and improves efficiency.
- New valve design for low pressure loss to achieve flow rate increase (15% up over the conventional model).
- End-face seal is achieved when connected.
- Enhanced operability with low connection resistance.
- End-face seal design is superior to external seal with an O-ring due to no seal damage caused by exhausted lubrication.
- Available only with steel body. Not suitable for water or oil.
- Also available with quick connect/disconnect Tube Fitter type.



▼ With Tube Fitter

## Specifications

Body material		Steel (Chrome plated)			
Size	Thread and hose barb	1/4", 3/8", 1/2"			
	Tube barb (Tube fitter) <sup>1</sup>	Polyurethane tube: Outer dia. $\phi 6 \pm 0.1$ , $\phi 8 \pm 0.15$ , $\phi 10 \pm 0.15$ Polyamide tube: Outer dia. $\phi 6^{+0.05}_{-0.08}$ , $\phi 8^{+0.05}_{-0.1}$ , $\phi 10^{+0.05}_{-0.1}$ Fluorine contained resin tube: Outer dia. $\phi 6 \pm 0.07$ , $\phi 8 \pm 0.07$ , $\phi 10 \pm 0.07$			
Pressure unit	MPa	kgf/cm <sup>2</sup>	bar	PSI	
Working pressure	1.5	15	15	218	
Seal material	Seal material	Mark	Working temperature range	Remarks	
Working temperature range <sup>2</sup>	Nitrile rubber	NBR	-20°C to +60°C	Standard material	

- Above specifications apply only to CUPLA. Maximum working pressure and working temperature range may vary depending on tube materials you use with and the working temperature.

\*1: When connecting an extremely soft tube such as soft polyurethane or soft nylon, attach the insert ring specified by the tube manufacturer to the inner diameter of the tube to be connected.

\*2: The operable temperature range depends on the operating conditions.

## Maximum Tightening Torque

Nm {kgf·cm}

Size (Thread)	1/4"	3/8"	1/2"
Torque	14 {143}	22 {224}	60 {612}

## Flow Direction

Fluid must run from socket to plug.



## Interchangeability

Interchangeable with plugs of HI CUPLA models 10, 17, 20, 30 and 40. Interchangeable with each models of NUT CUPLA series and HI CUPLA series (except models 400, 600, and 800). Please see page 21 for "HI CUPLA Series Interchangeability".

## Minimum Cross-Sectional Area

(mm<sup>2</sup>)

Socket \ Plug	Plug										
	17PH	20PH	30PH	40PH	10PM	20PM	30PM	40PM	20PF	30PF	40PF
200-17SH	16	16	16	16	13	16	16	16	16	16	16
200-20SH	16	20	20	20	13	20	20	20	20	20	20
200-30SH	16	20	41	41	13	41	41	41	41	41	41
200-40SH	16	20	41	41	13	41	41	41	41	41	41
200-20SM	16	20	41	41	13	41	41	41	41	41	41
200-30SM	16	20	41	41	13	41	41	41	41	41	41
200-40SM	16	20	41	41	13	41	41	41	41	41	41
200-20SF	16	20	41	41	13	41	41	41	41	41	41
200-30SF	16	20	41	41	13	41	41	41	41	41	41
200-40SF	16	20	41	41	13	41	41	41	41	41	41

## Suitability for Vacuum

Not suitable for vacuum application in either connected or disconnected condition.

## Pressure - Flow Characteristics

[Test conditions] - Fluid : Air

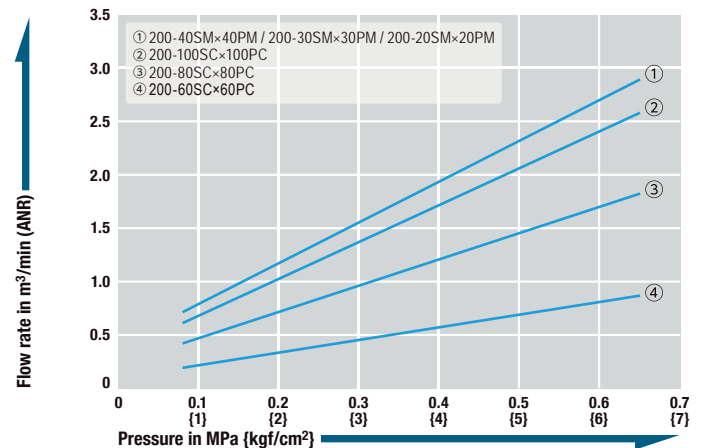



**Models and Dimensions**

WAF - WAF stands for width across flats.

**Socket SH type (Hose barb)**

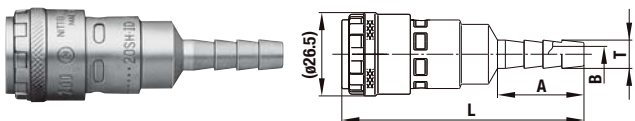

Model	Application (Hose)	Mass (g)	Dimensions (mm)			
			L	A	øT	øB
200-17SH	1/4"	86	(77)	27	7.2	4.5
200-20SH	1/4"	90	(77)	27.5	9	5
200-30SH	3/8"	92	(79)	32	11.3	7.5
200-40SH	1/2"	104	(79.5)	32	15	10

**Socket SM type (Male thread)**

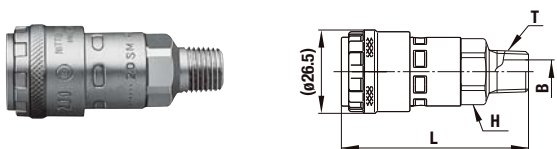

Model	Application (Thread)	Mass (g)	Dimensions (mm)			
			L	H(WAF)	T	øB
200-20SM	Rc 1/4	89	(60)	Hex.19	R 1/4	7.5
200-30SM	Rc 3/8	91	(60.5)	Hex.19	R 3/8	10
200-40SM	Rc 1/2	102	(56)	Hex.24	R 1/2	13

**Socket SF type (Female thread)**

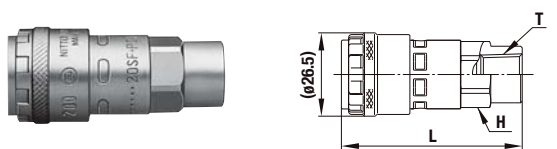

Models	Application (Thread)	Mass (g)	Dimensions (mm)		
			L	H(WAF)	T
200-20SF	R 1/4	94	(57.5)	Hex.19	Rc 1/4
200-30SF	R 3/8	103	(55.5)	Hex.22	Rc 3/8
200-40SF	R 1/2	138	(57.5)	Hex.29	Rc 1/2

**Socket SC type (Tube Fitter)**

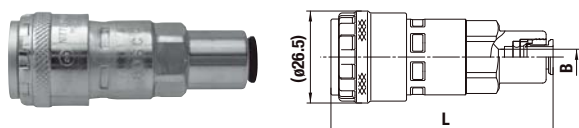

Model	Application (Tube)	Mass (g)	Dimensions (mm)	
			L	øB
200-60SC	For 6 mm OD tube	100	(64)	5
200-80SC	For 8 mm OD tube	105	(67.5)	6.5
200-100SC	For 10 mm OD tube	123	(70.5)	8.5

• The outer dimensions of Model 200-100SC are a little bit different from those of other models.

**Application example**

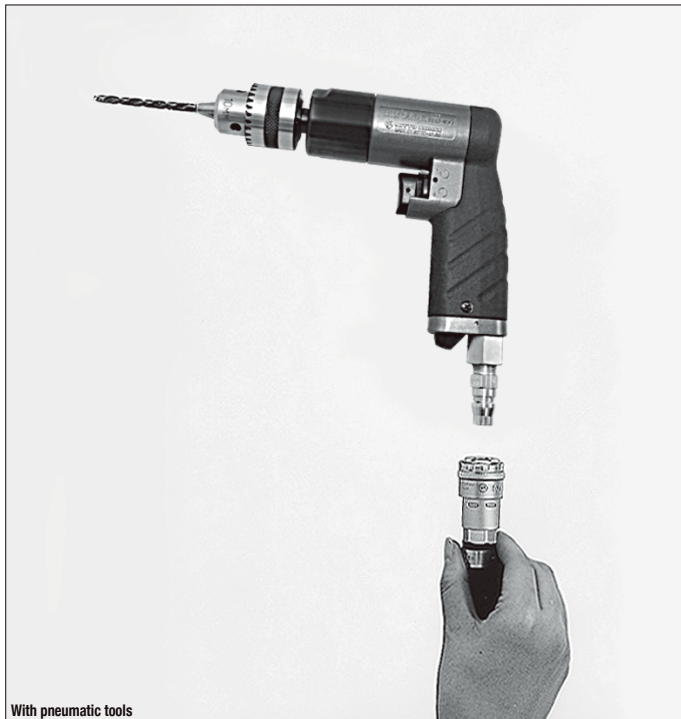

With pneumatic tools

**Socket and tube can be connected in one push-to-connect operation.**

Just push the tube into CUPLA and then it is locked.  
Polyurethane, Polyamide and Fluorine contained resin tubes.

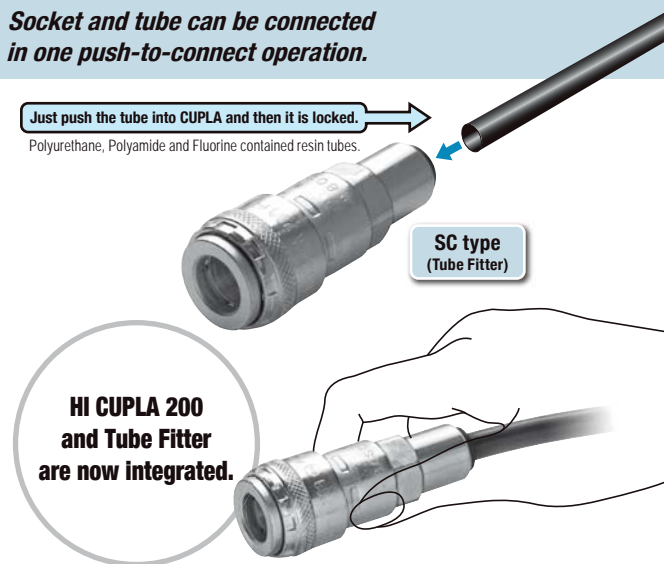

**HI CUPLA 200 and Tube Fitter are now integrated.**

Major applications: miniature pneumatic equipment, automatic control equipment, physicochemical equipment and medical devices.

**Just push in for quick connection.**



## For Low Pressure (Air)

# HI CUPLA for Connection to Braided Hoses

## NUT CUPLA

## NUT CUPLA 200

## ROTARY NUT CUPLA

For connection to urethane hose, braided hose

Working pressure

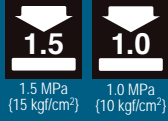

Valve structure



Applicable fluids (Steel applies to air only)



**No hose clamp required!**  
**Fitted with hose guard nut to prevent possible kinking.**  
**HI CUPLA for connection to braided hoses is now available.**

- Nut types are available in HI CUPLA Series and HI CUPLA 200 Series. Hose guard nut type available to prevent hose kinking.
- To mount on hose, simply slide it over the nipple and tighten the nut.
- The design to tighten outside of hose reduces hose slip away or fluid leaks.
- Also available are ROTARY NUT CUPLA equipped with ball bearing swivel mechanism to prevent and relieve tension on operator's hands.

NUT CUPLA

NUT CUPLA 200

NUT CUPLA 200 with hose guard nut



HI CUPLA for Connection to Braided Hoses

### Specifications (NUT CUPLA / NUT CUPLA 200 / ROTARY NUT CUPLA)

Body material	Steel (Chrome plated), Stainless Steel (SUS304)			
Urethane hose size	For ø5 mm×ø8 mm, ø6 mm×ø9 mm hose For ø6.5 mm×ø10 mm, ø8 mm×ø12 mm hose For ø8.5 mm×ø12.5 mm, ø11 mm×ø16 mm hose			
Pressure unit	MPa	kgf/cm <sup>2</sup>	bar	PSI
Working pressure	1.5	15	15	218
Seal material	Seal material	Mark	Working temperature range	Remarks
Working temperature range <sup>*1</sup>	Nitrile rubber	NBR	-20°C to +60°C	Standard material

\*1: The operable temperature range depends on the operating conditions.

### Specifications (HI CUPLA for Connection to Braided Hoses)

Body material	Steel (Chrome plated)		Brass	
Braided hose size	For ø9 mm×ø15 mm hose			
Working pressure	MPa	1.5	1.0	
	kgf/cm <sup>2</sup>	15	10	
	bar	15	10	
	PSI	218	145	
Seal material	Seal material	Mark	Working temperature range	Remarks
Working temperature range <sup>*1</sup>	Nitrile rubber	NBR	-20°C to +60°C	Standard material

- Maximum working pressure and temperature range of PN/SN type for braided hoses depends upon the specification of the braided hose to be used.

\*1: The operable temperature range depends on the operating conditions.

### Tightening Torque Range

Nm {kgf·cm}

Model	SN, PN, SNR Type	65SNG, PNG, SNRG Type	85SNG, PNG, SNRG Type
Torque	9 to 11 {92 to 112}	5 to 6 {51 to 61}	7 to 8 {71 to 82}

To mount on braided hose or urethane hose, slide it over to the hose barb and tighten the nut until it is flush against the hose barb base. It is recommended that grease is applied to the inside of the nut (threaded part and hose contact part) for easy tightening.

### Flow Direction

Fluid must run from socket to plug.



### Interchangeability

Interchangeable with HI CUPLA models 10, 17, 20, 30, 40, and 60.

Interchangeable with each models of NUT CUPLA series and HI CUPLA series (except models 400, 600, and 800). Please see page 21 for "HI CUPLA Series Interchangeability".

### Minimum Cross-Sectional Area

(mm<sup>2</sup>)

Socket	Plug	17PH	20PH	30PH	40PH	10PM	20PM	30PM	40PM	20PF	30PF	40PF	90PN-BH
		200-50SN	16	16	16	16	13	16	16	16	16	16	16
200-60SN	16	20	22	22	13	22	22	22	22	22	22	22	22
200-65SN	16	20	22	22	13	22	22	22	22	22	22	22	22
200-80SN	16	20	41	41	13	41	41	41	41	41	41	41	41
200-85SN	16	20	41	41	13	41	41	41	41	41	41	41	41
200-110SN	16	20	41	41	13	41	41	41	41	41	41	41	41
200-50SNG	16	16	16	16	13	16	16	16	16	16	16	16	16
200-65SNG	16	20	22	22	13	22	22	22	22	22	22	22	22
200-85SNG	16	20	40	41	13	41	41	41	41	41	41	41	41
90SN-BH	16	20	33	33	13	33	33	33	33	33	33	33	33

### Suitability for Vacuum

Not suitable for vacuum application in either connected or disconnected condition.

### Pressure - Flow Characteristics

[Test conditions] - Fluid: Air

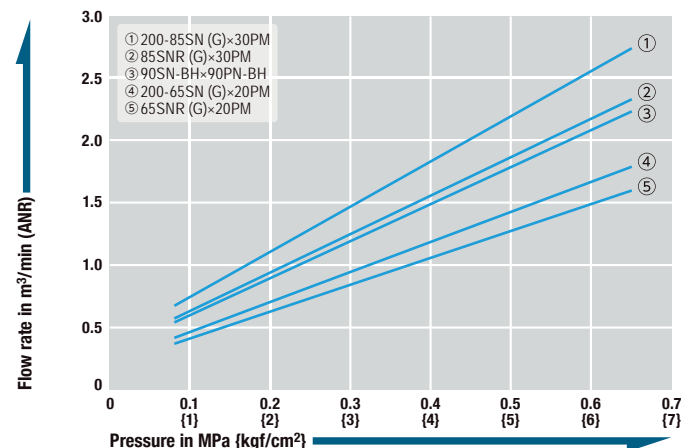

**Plug PN type (HI CUPLA for connection to braided hoses)**

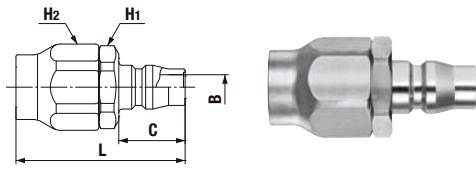

Grease is applied to the threaded part of steel nut to prevent galling.

Model	Application (Hose) <sup>1)</sup>		Body material·Mass (g)		Dimensions (mm)				
	Size (mm)	Hose wall thickness (mm)	Steel	Brass	L	H1(WAF)	H2(WAF)	C	øB
90PN-BH	ø9×ø15	3±0.3	86	88	(51)	Hex.23	Hex.24	20	7.5

**Socket SN type (HI CUPLA for connection to braided hoses)**

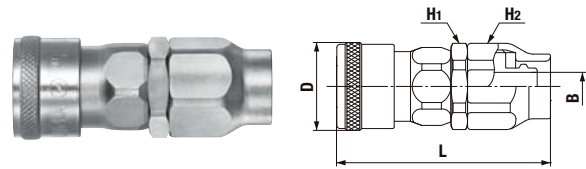

Grease is applied to the threaded part of steel nut to prevent galling.

Model	Application (Hose) <sup>1)</sup>		Body material·Mass (g)		Dimensions (mm)				
	Size (mm)	Hose wall thickness (mm)	Steel	Brass	L	øD	H1(WAF)	H2(WAF)	øB
90SN-BH	ø9×ø15	3±0.3	147	154	(64.5)	(26.5) <sub>2</sub>	Hex.24	Hex.24	8.5

**Plug PN type (NUT CUPLA for urethane hose connection)**

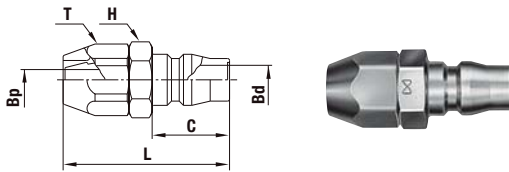

Grease is applied to the threaded part of stainless steel nut to prevent galling.

Model	Application (Hose)	Body material·Mass (g)		Dimensions (mm)					
		Steel	Stainless steel	L	C	øBp	øBd	H(WAF)	T(WAF)
50PN	ø5×ø8	30	-	(43)	20	4.5	7.5	Hex.17	Hex.17
60PN	ø6×ø9	40	-	(43)	20	5.3	7.5	Hex.17	Hex.17
65PN	ø6.5×ø10	42	43	(43)	20	5.3	7.5	Hex.17	Hex.17
80PN	ø8×ø12	50	52	(45)	20	7.5	7.5	Hex.19	Hex.19
85PN	ø8.5×ø12.5	52	53	(45)	20	7.5	7.5	Hex.19	Hex.19
110PN	ø11×ø16	75	-	(52)	20	7.5	7.5	Hex.23	Hex.24

**Socket SN type (NUT CUPLA for urethane hose connection)**

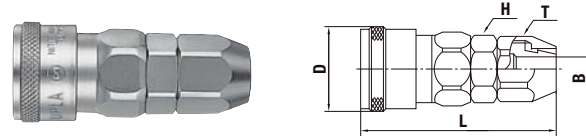

Grease is applied to the threaded part of stainless steel nut to prevent galling.

Model	Application (Hose)	Body material·Mass (g)		Dimensions (mm)				
		Steel	Stainless steel	L	øD	øB	H(WAF)	T(WAF)
50SN	ø5×ø8	117	-	(60)	(26.5)	4.5	Hex.19	Hex.17
60SN	ø6×ø9	115	-	(59.5)	(26.5)	5.3	Hex.19	Hex.17
65SN	ø6.5×ø10	115	110	(59.5)	(26.5) <sub>3</sub>	5.3	Hex.19	Hex.17
80SN	ø8×ø12	120	114	(61.5)	(26.5) <sub>3</sub>	7.5	Hex.19	Hex.19
85SN	ø8.5×ø12.5	120	115	(61.5)	(26.5) <sub>3</sub>	7.5	Hex.19	Hex.19
110SN	ø11×ø16	153	-	(64.5)	(26.5)	10	Hex.23	Hex.24

**Socket SN type (NUT CUPLA 200 for urethane hose connection)**

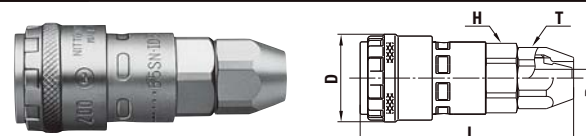

Model	Application (Hose)	Mass (g)	Dimensions (mm)				
			L	øD	øB	H(WAF)	T(WAF)
200-50SN	ø5×ø8	105	(64.5)	(26.5)	4.5	Hex.19	Hex.17
200-60SN	ø6×ø9	105	(64.5)	(26.5)	5.3	Hex.19	Hex.17
200-65SN	ø6.5×ø10	106	(64.5)	(26.5)	5.3	Hex.19	Hex.17
200-80SN	ø8×ø12	112	(66.5)	(26.5)	7.5	Hex.19	Hex.19
200-85SN	ø8.5×ø12.5	113	(66.5)	(26.5)	7.5	Hex.19	Hex.19
200-110SN	ø11×ø16	127	(62)	(26.5)	10	Hex.23	Hex.24

**Plug PNG type (For urethane hose with hose guard nut connection)**

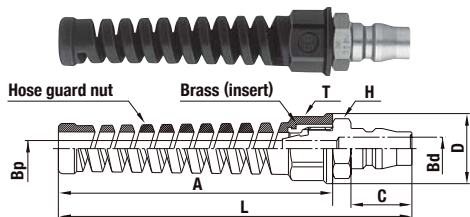

Model	Application (Hose)	Mass (g)	Dimensions (mm)							
			L	C	A	øD	øBp	øBd	H(WAF)	T(WAF)
50PNG *4	ø5×ø8	41	(116)	20	90	23	4.5	7.5	Hex.17	Hex.19
65PNG	ø6.5×ø10	43	(116)	20	90	23	5.3	7.5	Hex.17	Hex.19
85PNG	ø8.5×ø12.5	55	(116)	20	90	26	7.5	7.5	Hex.19	Hex.22

**Socket SNG type (For urethane hose with hose guard nut connection)**

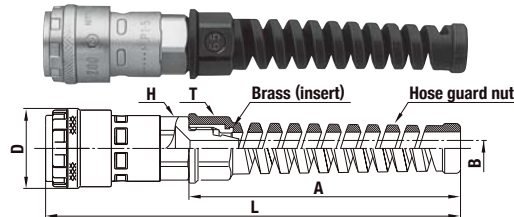

Model	Application (Hose)	Mass (g)	Dimensions (mm)					
			L	A	øD	øB	H(WAF)	T(WAF)
200-50SNG *4	ø5×ø8	105	(137.5)	90	(26.5)	4.5	Hex.19	Hex.19
200-65SNG	ø6.5×ø10	107	(137.5)	90	(26.5)	5.3	Hex.19	Hex.19
200-85SNG	ø8.5×ø12.5	116	(137.5)	90	(26.5)	7.5	Hex.19	Hex.22

**Socket SNR type (ROTARY NUT CUPLA with swivel mechanism)**

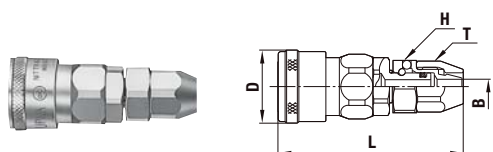

Model	Application (Hose)	Mass (g)	Dimensions (mm)				
			L	øD	øB	H(WAF)	T(WAF)
65SNR	ø6.5×ø10	120	(67.3)	(26.5)	5.3	Hex.19	Hex.17
85SNR	ø8.5×ø12.5	136	(69.3)	(26.5)	7.5	Hex.21	Hex.19

**Socket SNRG type (ROTARY NUT CUPLA with swivel mechanism)**

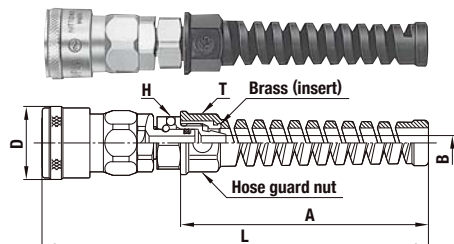

Model	Application (Hose)	Mass (g)	Dimensions (mm)					
			L	A	øD	øB	H(WAF)	T(WAF)
65SNRG	ø6.5×ø10	121	(140.3)	90	(26.5)	5.3	Hex.19	Hex.19
85SNRG	ø8.5×ø12.5	139	(140.3)	90	(26.5)	7.5	Hex.21	Hex.22

The pictures of HI CUPLA for connection to braided hoses and PN type and SN type of NUT CUPLA show steel bodies.

\*1 Braided hoses for HI CUPLA for Connection to Braided Hoses should be made of soft PVC and woven by reinforcement thread. \*2: Brass: øD=25.4 \*3: Stainless steel: øD=25.4 \*4: Made-to-order item

For Low Pressure (Air)

# LOCK CUPLA 200

Air line coupling with separation prevention mechanism

Working pressure: **1.5** MPa (15 kgf/cm<sup>2</sup>)

Valve structure: One-way shut-off

Applicable fluid: Air

## Push-to-connect operation. Added easy lock design for safety!

- Separation prevention mechanism prevents accidental disconnection after connection. Good for connections between hoses.
- Simple one push of plug and socket to each other for connection. Easy handling improves job efficiency.
- Ball bearing swivel mechanism prevents hose twists and relieves load on holding hands (SNRG type).
- To mount on hose, simply slide it over the nipple and tighten the nut (SNRG type).
- Hose guard nut to prevent hose from kinking as a standard feature (SNRG type).
- Low pressure loss valve design gives improved flow rate.



### Suitability for Vacuum

Not suitable for vacuum application in either connected or disconnected condition.

### Minimum Cross-sectional Area (mm<sup>2</sup>)

Plug	17PH	20PH	30PH	40PH	10PM	20PM	30PM	40PM	20PF	30PF	40PF
LOCK CUPLA 200											
L200-20SH	16	20	20	20	13	20	20	20	20	20	20
L200-30SH	16	20	41	41	13	41	41	41	41	41	41
L200-40SH	16	20	41	41	13	41	41	41	41	41	41
L200-20SM	16	20	41	41	13	41	41	41	41	41	41
L200-30SM	16	20	41	41	13	41	41	41	41	41	41
L200-40SM	16	20	41	41	13	41	41	41	41	41	41
L200-20SF	16	20	41	41	13	41	41	41	41	41	41
L200-30SF	16	20	41	41	13	41	41	41	41	41	41
L200-40SF	16	20	41	41	13	41	41	41	41	41	41
L200-65SNRG	16	20	20	20	13	20	20	20	20	20	20
L200-85SNRG	16	38	38	38	13	38	38	38	38	38	38

### Pressure - Flow Characteristics

[Test conditions] - Fluid : Air

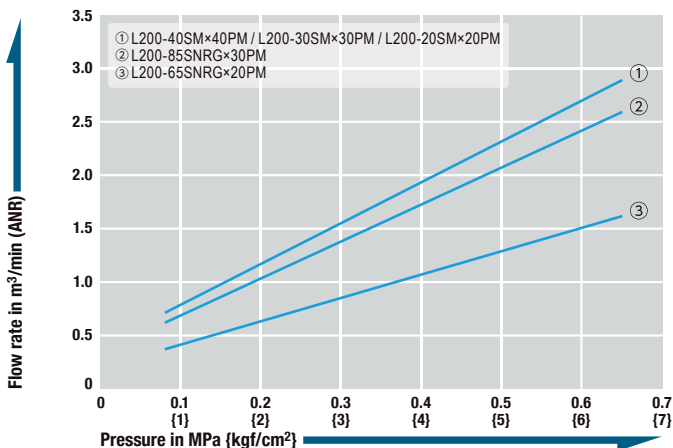

Specifications				
Body material	Steel (Chrome plated)			
Size	Thread and hose barb	1/4", 3/8", 1/2"		
	SNRG type	For ø6.5 mm×ø10 mm, ø8.5 mm×ø12.5 mm hose		
Pressure unit	MPa	kgf/cm <sup>2</sup>	bar	PSI
Working pressure	1.5	15	15	218
Seal material	Seal material	Mark	Working temperature range	Remarks
Working temperature range <sup>*1</sup>	Nitrile rubber	NBR	-20°C to +60°C	Standard material

\*1: The operable temperature range depends on the operating conditions.

### Maximum Tightening Torque, Tightening Torque Range Nm {kgf·cm}

Type of connection	Thread			Hose guard nut	
Applicable size	1/4"	3/8"	1/2"	ø6.5 mm×ø10 mm	ø8.5 mm×ø12.5 mm
Torque	14 {143}	22 {224}	60 {612}	5 to 6 {51 to 61}	7 to 8 {71 to 82}

To mount on urethane hose, slide it over to the hose barb and tighten the nut until it is flush against the hose barb base. It is recommended that grease is applied to the inside of the nut (threaded part and hose contact part) for easy tightening.

### Flow Direction

Fluid must run from socket to plug.



### Interchangeability

Interchangeable with plugs of HI CUPLA models 10, 17, 20, 30 and 40. Interchangeable with each models of NUT CUPLA series and HI CUPLA series. Please see page 21 for "HI CUPLA Series Interchangeability".

### Models and Dimensions

WAF : WAF stands for width across flats.

#### Socket SH type (Hose barb)

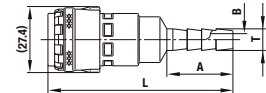

Model	Application (Hose)	Mass (g)	Dimensions (mm)			
			L	A	øT	øB
L200-20SH	1/4"	90	(77)	27.5	9	5
L200-30SH	3/8"	92	(79)	32	11.3	7.5
L200-40SH	1/2"	104	(79.5)	32	15	10

#### Socket SM type (Male thread)

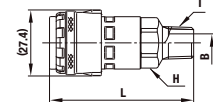

Model	Application (Thread)	Mass (g)	Dimensions (mm)			
			L	H(WAF)	T	øB
L200-20SM	Rc 1/4	89	(60)	Hex.19	R 1/4	7.5
L200-30SM	Rc 3/8	91	(60.5)	Hex.19	R 3/8	10
L200-40SM	Rc 1/2	102	(56)	Hex.24	R 1/2	13

#### Socket SF type (Female thread)

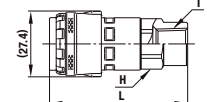

Model	Application (Thread)	Mass (g)	Dimensions (mm)		
			L	H(WAF)	T
L200-20SF	R 1/4	94	(57.5)	Hex.19	Rc 1/4
L200-30SF	R 3/8	103	(55.5)	Hex.22	Rc 3/8
L200-40SF	R 1/2	138	(57.5)	Hex.29	Rc 1/2

#### Socket SNRG type (For hose with hose guard nut connection)

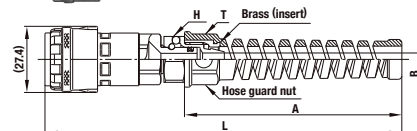
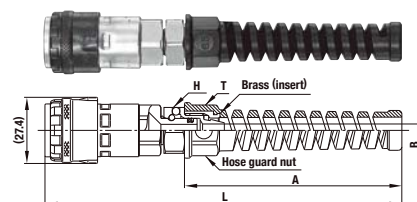

Model	Application (Hose)	Mass (g)	Dimensions (mm)				
			L	A	H(WAF)	T(WAF)	øB
L200-65SNRG	ø6.5 mm×ø10 mm	125	(147.8)	(90)	Hex.19	Hex.19	5.3
L200-85SNRG	ø8.5 mm×ø12.5 mm	132	(146.8)	(90)	Hex.21	Hex.22	7.5

For Low Pressure (Air)

# HI CUPLA Two Way Type

For bi-directional compressed air flow

Working pressure



Valve structure



Applicable fluid



Air flows in either direction from plug or from socket side when coupled.  
Ideal for connection of factory air supply lines to pneumatic devices.

- Can be connected with plugs for HI CUPLA Models 10, 17, 20, 30 and 40 and allows fluid to flow from either plug or socket side when coupled.
- Wide range of connections such as from ports on air pipes in factory to individual pneumatic devices.
- Critical structural parts are heat-treated for increased strength giving greater durability and resistance to wear.
- Available in various sizes and end configurations to suit a wide range of applications.



## Pressure - Flow Characteristics

[Test conditions] - Fluid : Air

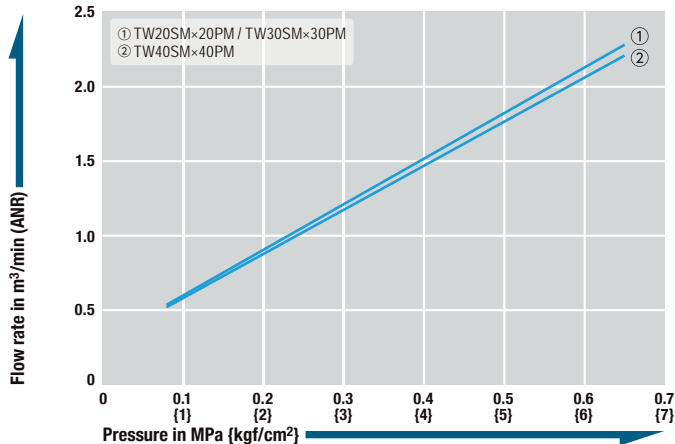

## Specifications

Body material of brass or stainless steel is available as made-to-order item.

Body material		Steel (Chrome plated)			
Size	Thread	1/4", 3/8", 1/2"			
	Hose barb	For ø6.5 mm×ø10 mm, ø8.5 mm×ø12.5 mm hose			
Pressure unit	MPa	kgf/cm <sup>2</sup>	bar	PSI	
Working pressure	1.5	15	15	218	
Seal material	Seal material	Mark	Working temperature range	Remarks	
Working temperature range *1	Nitrile rubber	NBR	-20°C to +80°C	Standard material	
	Fluoro rubber	FKM	-20°C to +180°C	Made-to-order item	

\*1: The operable temperature range depends on the operating conditions.

## Maximum Tightening Torque

Nm {kgf·cm}

Size (Thread)	1/4"	3/8"	1/2"
Torque	14 {143}	22 {224}	60 {612}

## Flow Direction

Fluid flow can be bi-directional when socket and plug are connected.



## Interchangeability

Interchangeable with plugs of HI CUPLA models 10, 17, 20, 30 and 40.  
Interchangeable with each models of NUT CUPLA series and HI CUPLA series.  
Please see page 21 for "HI CUPLA Series Interchangeability".

## Suitability for Vacuum

Not suitable for vacuum application in either connected or disconnected condition.

## Models and Dimensions

WAF : WAF stands for width across flats.

### Socket SH type (Hose barb)

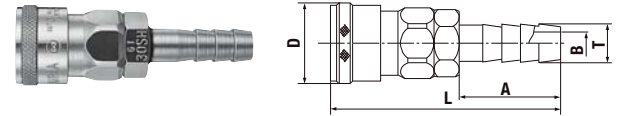

Model	Application (Hose)	Mass (g)	Dimensions (mm)				
			L	øD	A	øT	øB
TW20SH	1/4"	98	(72.5)	(26.5)	30	9	5
TW30SH	3/8"	102	(76.5)	(26.5)	34	11.3	7.5
TW40SH	1/2"	117	(78.5)	(26.5)	36	15	9

### Socket SM type (Male thread)

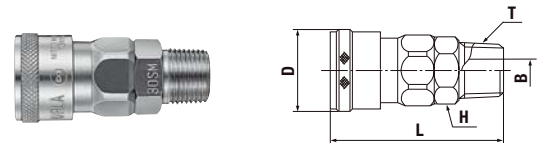

Model	Application (Thread)	Mass (g)	Dimensions (mm)				
			L	øD	H(WAF)	T	øB
TW20SM	Rc 1/4	95	(55.5)	(26.5)	Hex.19	R 1/4	7
TW30SM	Rc 3/8	109	(56.5)	(26.5)	Hex.19	R 3/8	8
TW40SM	Rc 1/2	116	(59.5)	(26.5)	Hex.23	R 1/2	9

### Socket SF type (Female thread)

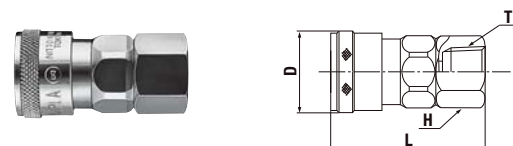

Model	Application (Thread)	Mass (g)	Dimensions (mm)			
			L	øD	H(WAF)	T
TW20SF	R 1/4	95	(49.5)	(26.5)	Hex.19	Rc 1/4
TW30SF	R 3/8	96	(50.5)	(26.5)	Hex.21	Rc 3/8
TW40SF	R 1/2	137	(52.5)	(26.5)	Hex.29	Rc 1/2



For Low Pressure (Air)

# FULL BLOW CUPLA

Air line coupling with low pressure loss, high flow rate, and built-in purge function

<p>Working pressure</p> <p>1.5 MPa (15 kgf/cm<sup>2</sup>)</p>	<p>Valve structure</p> <p>One-way shut-off</p>	<p>Applicable fluid</p> <p>Air</p>
--	--	------------------------------------

Unique full-open gate type valve mechanism realizes low pressure loss and high flow rate, which reduces required source air volume.

- The flow rate is increased by up to 40% more than that of HI CUPLA.
- During connection and disconnection, the valve is closed, enabling connection/disconnection under zero line pressure.
- When the sleeve of socket is returned to its original position, the purge mechanism releases the residual air pressure in the plug, eliminating unpleasant popping noise and hose whip motion on disconnection.
- Separation prevention mechanism prevents accidental disconnection of CUPLA, ensuring safe operation.
- The valve can be opened and closed while the socket and plug are connected.
- The weight is reduced by 30 to 45% compared with that of conventional CUPLA.
- Plug and socket with hose guard nut are also available (see page 68 of NK CUPLA HOSE for details).

Note: Direct mounting of FULL BLOW CUPLA to percussive and vibrating tools should be avoided.

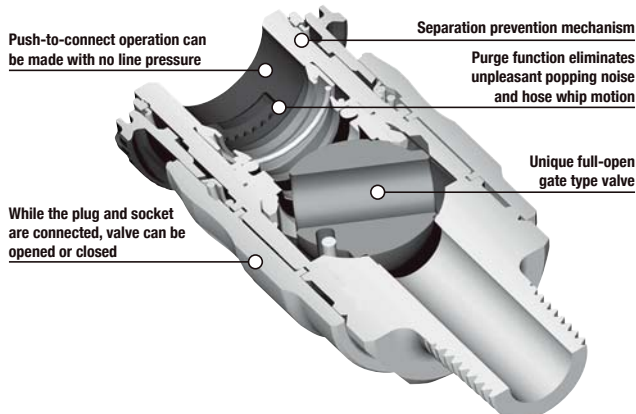

Specifications				
Body material	Aluminum alloy			
Size	Thread and hose barb	1/4", 3/8", 1/2"		
	SN type for urethane hose	For ø6.5 mm×ø10 mm, ø8 mm×ø12 mm polyurethane hose For ø8.5 mm×ø12.5 mm, ø11 mm×ø16 mm polyurethane hose		
Pressure unit	MPa	kgf/cm <sup>2</sup>	bar	PSI
Working pressure	1.5	15	15	218
Seal material	Seal material	Mark	Working temperature range	Remarks
Working temperature range <sup>*1</sup>	Nitrile rubber	NBR	-20 °C to +60 °C	Standard material

\*1: The operable temperature range depends on the operating conditions.

Maximum Tightening Torque			Nm {kgf·cm}
Size (Thread)	1/4"	3/8"	1/2"
Torque	14 {143}	22 {224}	60 {612}

Tightening Torque Range		Nm {kgf·cm}
SN Type for urethane hose		
		9 to 11 {92 to 112}

To mount on urethane hose, slide it over to the hose barb and tighten the nut until it is flush against the hose barb base. It is recommended that grease is applied to the inside of the nut (threaded part and hose contact part) for easy tightening.

**Flow Direction**

Fluid must run from socket to plug.

**Interchangeability**

Interchangeable with plugs of HI CUPLA models 10, 17, 20, 30 and 40. Interchangeable with each models of NUT CUPLA series and HI CUPLA series. Not interchangeable with some plugs of plastic HI CUPLA 250 (discontinued product). Please see page 21 for "HI CUPLA Series Interchangeability".

Minimum Cross-Sectional Area		(mm <sup>2</sup> )										
Socket	Plug	17PH	20PH	30PH	40PH	10PM	20PM	30PM	40PM	20PF	30PF	40PF
FBH-20SH		16	20	24	24	13	24	24	24	24	24	24
FBH-30SH		16	20	44	44	13	44	44	44	44	44	44
FBH-40SH		16	20	44	44	13	44	44	44	44	44	44
FBH-20SM		16	20	44	44	13	44	44	44	44	44	44
FBH-30SM		16	20	44	44	13	44	44	44	44	44	44
FBH-40SM		16	20	44	44	13	44	44	44	44	44	44
FBH-20SF		16	20	44	44	13	44	44	44	44	44	44
FBH-30SF		16	20	44	44	13	44	44	44	44	44	44
FBH-40SF		16	20	44	44	13	44	44	44	44	44	44
FBH-65SN		16	20	24	24	13	24	24	24	24	24	24
FBH-80SN		16	20	44	44	13	44	44	44	44	44	44
FBH-85SN		16	20	44	44	13	44	44	44	44	44	44
FBH-110SN		16	20	44	44	13	44	44	44	44	44	44

**Suitability for Vacuum**

Not suitable for vacuum application in either connected or disconnected condition.

**Pressure - Flow Rated Characteristics (Comparison with HI CUPLA)**

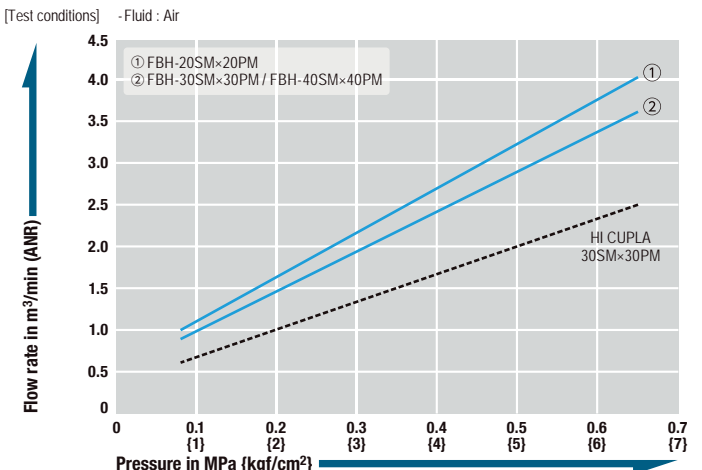



**Models and Dimensions** WAF · WAF stands for width across flats.

**Socket SH type (Hose barb)**

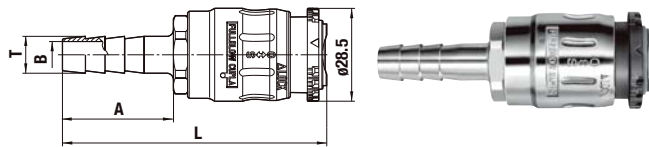

Model	Application (Hose)	Mass (g)	Dimensions (mm)			
			L	A	øT	øB
FBH-20SH	1/4"	70	(77)	30	9	5.5
FBH-30SH	3/8"	74	(81)	34	11.3	8
FBH-40SH	1/2"	85	(83)	36	15	10

**Socket SM type (Male thread)**

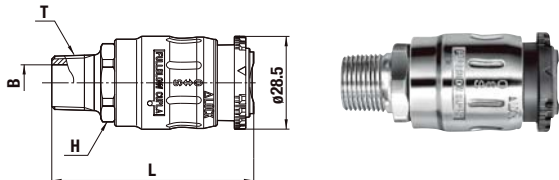

Model	Application (Thread)	Mass (g)	Dimensions (mm)			
			L	H(WAF)	T	øB
FBH-20SM	Rc 1/4	71	(62)	Hex.22	R 1/4	8
FBH-30SM	Rc 3/8	75	(62)	Hex.22	R 3/8	11
FBH-40SM	Rc 1/2	86	(66)	Hex.22	R 1/2	15

**Socket SF type (Female thread)**

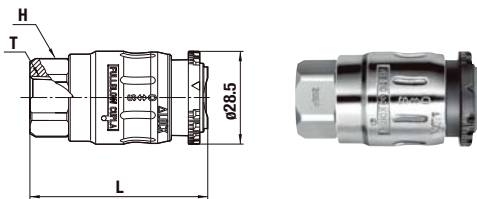

Model	Application (Thread)	Mass (g)	Dimensions (mm)		
			L	H(WAF)	T
FBH-20SF	R 1/4	77	(54.5)	Hex.22	Rc 1/4
FBH-30SF	R 3/8	69	(54.5)	Hex.22	Rc 3/8
FBH-40SF	R 1/2	90	(61)	Hex.26	Rc 1/2

**Socket SN type (For urethane hose connection)**

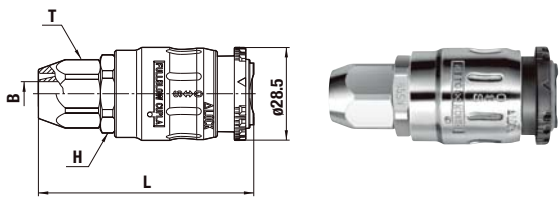

Model	Application (Hose)	Mass (g)	Dimensions (mm)			
			L	H(WAF)	T(WAF)	øB
FBH-65SN	ø6.5 mm×ø10 mm	64	(64)	Hex.22	Hex.17	5.5
FBH-80SN	ø8 mm×ø12 mm	67	(66)	Hex.22	Hex.19	7.5
FBH-85SN	ø8.5 mm×ø12.5 mm	68	(66)	Hex.22	Hex.19	7.5
FBH-110SN	ø11 mm×ø16 mm	86	(71)	Hex.26	Hex.24	10

**Features of FULL BLOW CUPLA**

**Up to about 40% increase in flow rate.**

Pressure loss is reduced to the ultimate level. Up to about 40% increase in flow rate compared with conventional CUPLA.

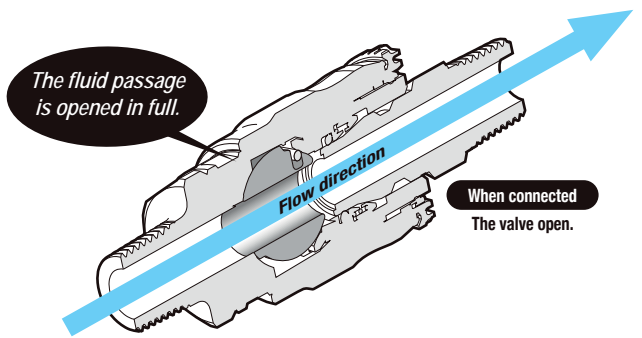
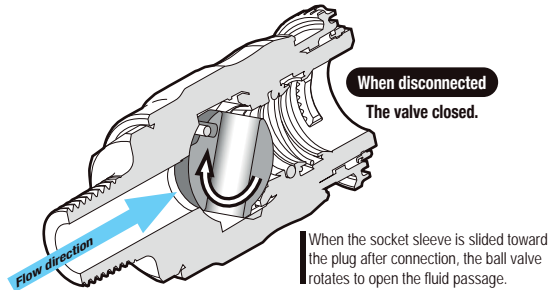

**Accessory**

**Soft plastic cover for FULL BLOW CUPLA SLEEVE COVER**

- Easier sliding operation is achieved by attaching an additional plastic cover over the socket sleeve of FULL BLOW CUPLA.
- Plastic covers reduce the risk of damage if CUPLA strikes other components or products.

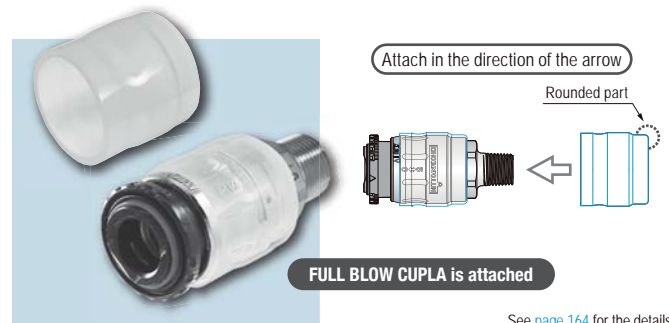

See page 164 for the details.

**How It Works**

**1. Open the valve**

Only after connection with the plug, you can slide the socket sleeve B toward the plug in order to open the built-in valve. Full flow path is then obtained.

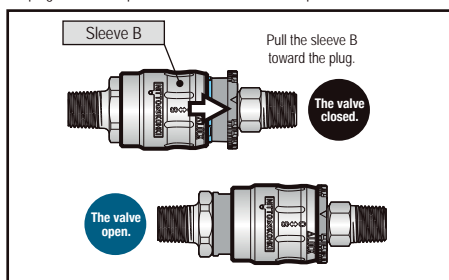

**2. Lock the sleeve**

Rotate the flange counterclockwise to lock the sleeve B. Without unlocking the plug you cannot disconnect.

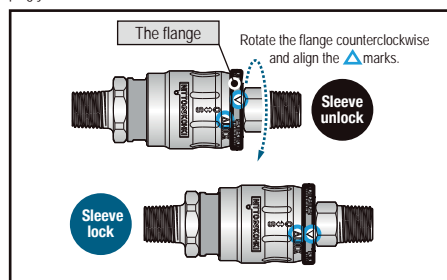

**3. Purge the residual air**

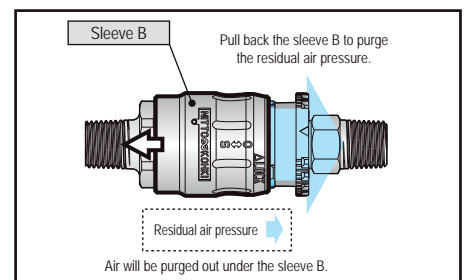

To disconnect the plug, first turn the flange back to its original position for unlocking and then pull the sleeve B back to the original position. The built-in valve will be closed to purge the residual air pressure.



For Low Pressure (Air)

# PURGE HI CUPLA PVR Type

Air line coupling with built-in residual air pressure release function

<p>Working pressure</p>  <p>1.5 MPa (15 kgf/cm<sup>2</sup>)</p>	<p>Valve structure</p>  <p>One-way shut-off</p>	<p>Applicable fluid</p>  <p>Air</p>
---	--	--

Connection can be made smoothly regardless of the existing pressure inside the socket.

- Push-to-connect operation. Easy one-hand operation.
- Built-in separation prevention mechanism prevents accidental disconnection of CUPLA, ensuring safe operation.
- Upon completion of sleeve locking the valve will open to supply air.
- When the sleeve is turned back to its original position, the valve is closed and purges residual air pressure in the plug without unpleasant popping noise and hose whip motion on disconnection.
- Even after connection, valve opening/closing control is possible.
- Flow rate increases by approximately 20% over that of HI CUPLA Model 400SM.
- Can be connected with plugs for HI CUPLA Models 400, 600 and 800.

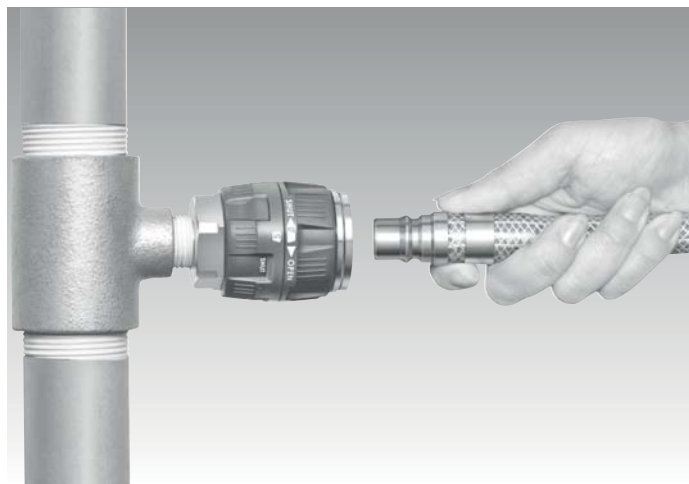

Specifications				
Body material	Zinc alloy (part Brass and others)			
Size	Thread	1/2", 3/4", 1"		
	Hose barb	1/2", 3/4", 1" hose		
Pressure unit	MPa	kgf/cm <sup>2</sup>	bar	PSI
Working pressure	1.5	15	15	218
Seal material	Seal material	Mark	Working temperature range	Remarks
Working temperature range <sup>*1</sup>	Nitrile rubber	NBR	-20°C to +60°C	Standard material

\*1: The operable temperature range depends on the operating conditions.

Maximum Tightening Torque	Nm {kgf·cm}		
Size (Thread)	1/2"	3/4"	1"
Torque	30 {306}	50 {510}	65 {663}

**Flow Direction**

Fluid must run from socket to plug.

**Interchangeability**

Can be connected with plugs of HI CUPLA models 400, 600 and 800. Please see page 21 for "HI CUPLA Series Interchangeability".

Socket \ Plug	Minimum Cross-Sectional Area (mm <sup>2</sup> )								
	400PH	600PH	800PH	400PM	600PM	800PM	400PF	600PF	800PF
PVR-400SH	64	71	71	71	71	71	71	71	71
PVR-600SH	64	116	116	116	116	116	116	116	116
PVR-800SH	64	116	116	116	116	116	116	116	116
PVR-400SM	64	116	116	116	116	116	116	116	116
PVR-600SM	64	116	116	116	116	116	116	116	116
PVR-800SM	64	116	116	116	116	116	116	116	116
PVR-400SF	64	116	116	116	116	116	116	116	116
PVR-600SF	64	116	116	116	116	116	116	116	116
PVR-800SF	64	116	116	116	116	116	116	116	116

**Suitability for Vacuum**

Not suitable for vacuum application in either connected or disconnected condition.

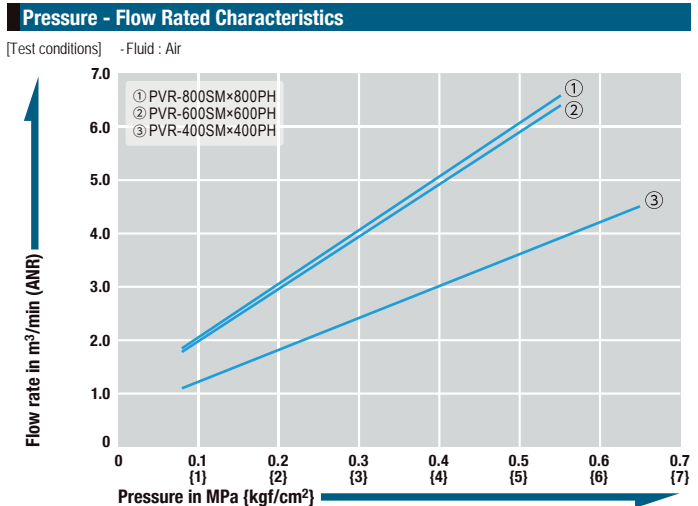

**Models and Dimensions**

WAF : WAF stands for width across flats.

**Socket SH type (Hose barb)**

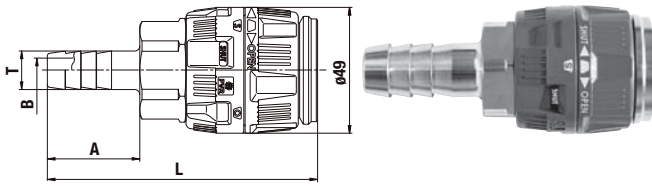

Model	Application (Hose)	Mass (g)	Dimensions (mm)			
			L	A	øT	øB
PVR-400SH	1/2"	380	(105)	36	15	9.5
PVR-600SH	3/4"	361	(109)	45	21	14
PVR-800SH	1"	440	(118)	55	27	16

**Socket SM type (Male thread)**

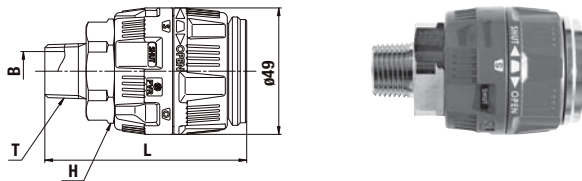

Model	Application (Thread)	Mass (g)	Dimensions (mm)			
			L	H(WAF)	T	øB
PVR-400SM	Rc 1/2	327	(78)	Hex.35	R 1/2	14
PVR-600SM	Rc 3/4	345	(82)	Hex.35	R 3/4	18
PVR-800SM	Rc 1	374	(84)	Hex.35	R 1	24

**Socket SF type (Female thread)**

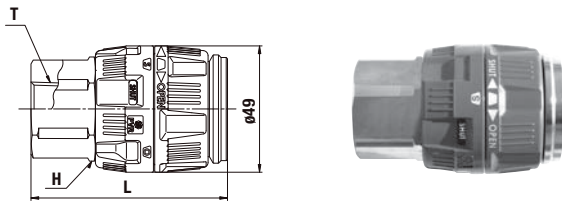

Model	Application (Thread)	Mass (g)	Dimensions (mm)		
			L	H(WAF)	T
PVR-400SF	R 1/2	394	(76)	Hex.35	Rc 1/2
PVR-600SF	R 3/4	370	(77)	Hex.35	Rc 3/4
PVR-800SF	R 1	440	(82)	Hex.41	Rc 1

**Function of PURGE HI CUPLA PVR Type**

**1. Connection**

Valve opening/closing operation and plug connection to socket can be made independently. Push-to-connect operation is achieved regardless of existing pressure inside the pipe.

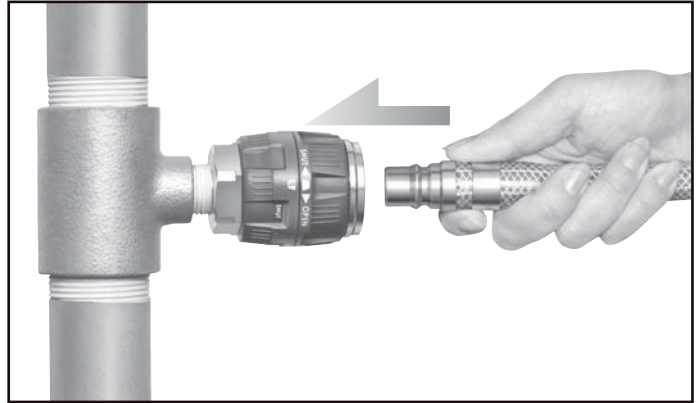

**2. Open the valve and lock the sleeve.**

Turning the operation ring will open the valve in the socket to supply air and lock the sleeve to prevent accidental disconnection.

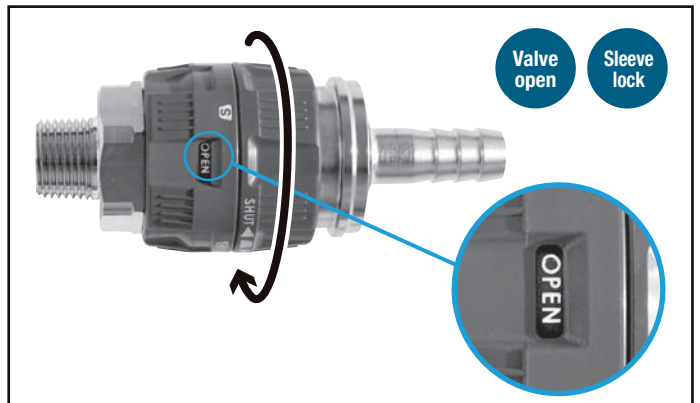

**3. Close the valve and unlock the sleeve**

Turning the operation ring back to its original position will close the valve and stop air flow, release the residual air pressure in the plug, and unlock the sleeve.

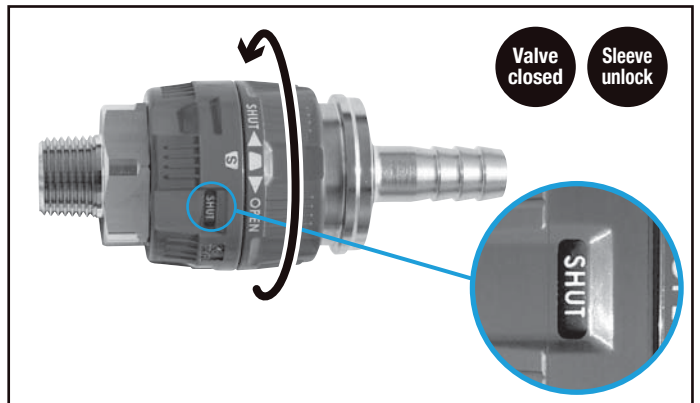

**4. Disconnection**

Disconnection can be made without unpleasant popping noise and hose whip motion due to no residual air pressure inside the plug.

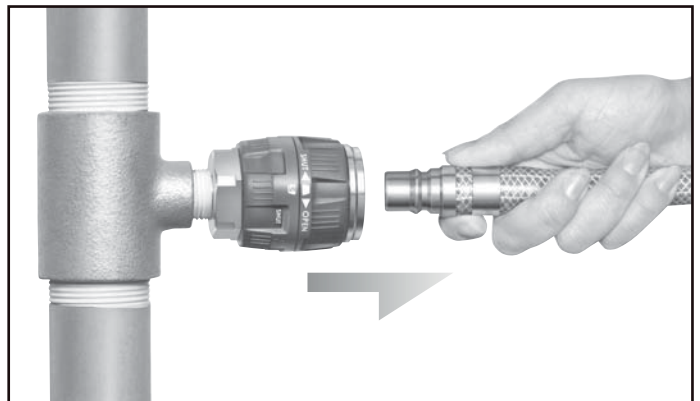

For Low Pressure (Air)

# PURGE HI CUPLA

Air line coupling with residual pressure release function

<b>Working pressure</b>	<b>Valve structure</b>	<b>Applicable fluid</b>
1.0 MPa (10 kgf/cm <sup>2</sup> )	One-way shut-off	Air

**Push-to-connect operation even with existing internal pressure! Eliminates unpleasant popping noise and hose whip motion on disconnection.**

- Just push in the plug for connection regardless of internal pressure in socket.
- Even after connection, lever operation gives perfect control over valve opening/closing.
- In disconnection, lever action releases residual air pressure in the plug without unpleasant popping noise and hose whip motion.
- Safe design prevents lever-operated valve from opening when plug is not connected.

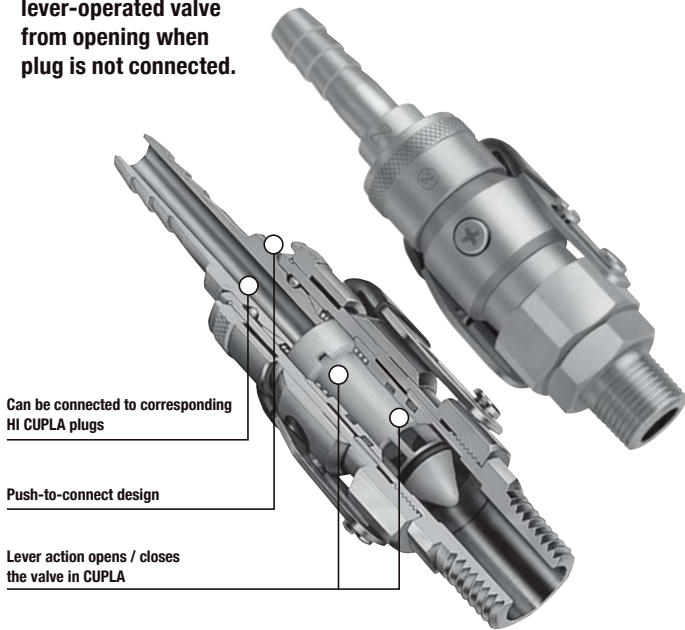

## How to Operate

<b>1</b> 	Just push the plug into socket. (In this stage the valve of the socket is not open.)
<b>2</b> 	Turning down the lever opens the valve and allows the fluid flow. (The turned-down lever works as a sleeve stopper and prevents disconnection.)
<b>3</b> 	When the lever is pulled up, residual air pressure in the plug is purged without unpleasant popping noise and hose whip motion on disconnection. In this stage, the socket valve is still closed.

## Specifications

Body material	Brass (Chrome plated)			
Size (Thread)	1/4", 3/8", 1/2", 3/4"			
Pressure unit	MPa	kgf/cm <sup>2</sup>	bar	PSI
Working pressure	1.0	10	10	145
Seal material	Seal material	Mark	Working temperature range	Remarks
Working temperature range *1	Nitrile rubber	NBR	-20°C to +60°C	Standard material

\*1: The operable temperature range depends on the operating conditions.

## Maximum Tightening Torque

Nm {kgf·cm}

Model	PV-20SM	PV-30SM	PV-40SM	PV-400SM	PV-600SM
Torque	9 {92}	11 {112}	30 {306}	30 {306}	50 {510}

## Flow Direction

Fluid must run from socket to plug.

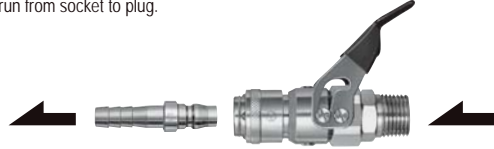

## Interchangeability

Models 20, 30 and 40 can be connected to plugs of HI CUPLA Models 10, 17, 20, 30 and 40. Interchangeable with each models of NUT CUPLA series and HI CUPLA series. Models 400 and 600 can be connected with plugs of HI CUPLA models 400, 600 and 800. Please see page 21 for "HI CUPLA Series Interchangeability".

## Minimum Cross-Sectional Area

(mm<sup>2</sup>)

Model	PV-20SM	PV-30SM	PV-40SM	PV-400SM	PV-600SM
Min. cross-sectional area	38	41	41	94	94

## Suitability for Vacuum

Not suitable for vacuum application in either connected or disconnected condition.

## Pressure - Flow Characteristics

[Test conditions] - Fluid : Air

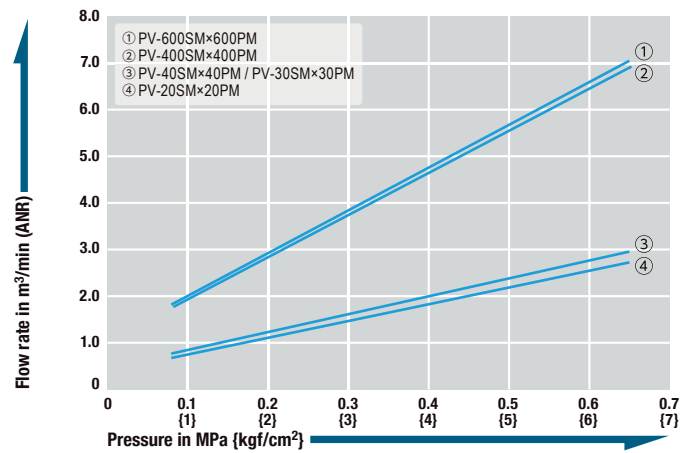

## Models and Dimensions

WAF : WAF stands for width across flats.

### Socket

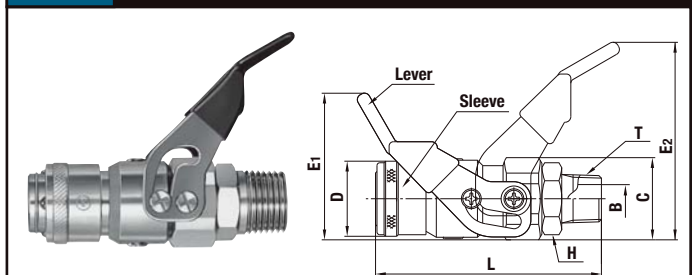



Model	Application (Thread)	Mass (g)	Dimensions (mm)						
			L	øD	E <sub>1</sub>	E <sub>2</sub>	H(WAF)	øC	T
PV-20SM	Rc 1/4	225 (79)	26.5	(50.5)	(70)	Hex.22	29	R 1/4	7
PV-30SM	Rc 3/8	229 (80)	26.5	(50.5)	(70)	Hex.22	29	R 3/8	10
PV-40SM	Rc 1/2	235 (82)	26.5	(50.5)	(70)	Hex.22	29	R 1/2	14
PV-400SM	Rc 1/2	411 (94)	35	(61.5)	(82)	Hex.30	37.5	R 1/2	13
PV-600SM	Rc 3/4	424 (97)	35	(61.5)	(82)	Hex.30	37.5	R 3/4	18



For Low Pressure (Air)

# PURGE LINE CUPLA

Simple air line coupling manifold with residual pressure release function

<p>Working pressure</p>  <p>1.0 MPa (10 kgf/cm<sup>2</sup>)</p>	<p>Valve structure</p>  <p>One-way shut-off</p>	<p>Applicable fluid</p>  <p>Air</p>
--	--	--

**Residual pressure can be released by a mere lever turn. Very smooth connection/disconnection!**

- Single action, just push in the plug to connect regardless of internal pressure in socket.
- No unpleasant noise of air pressure discharge and no hose whip motion on disconnection for safety operation.
- Safe design – socket valve will not open or close unless plug is connected.
- Even after connection, a lever turn will open/close valve with perfect control of air flow or line shut-off.
- Enables simultaneous air supply to three outlets from a single air line.  
(A single outlet PURGE HI CUPLA is also available - see the pages of PURGE HI CUPLA for details.)



## Application Example



## Specifications

Body material	Brass (Chrome plated)			
Size	Inlet	R 1/2		
	Outlet	Socket (PV-30SM)		
Pressure unit	MPa	kgf/cm <sup>2</sup>	bar	PSI
Working pressure	1.0	10	10	145
Seal material	Seal material	Mark	Working temperature range	Remarks
Working temperature range <sup>*1</sup>	Nitrile rubber	NBR	-20°C to +60°C	Standard material

\*1: The operable temperature range depends on the operating conditions.

## Maximum Tightening Torque

Nm {kgf·cm}

Size (Thread)	1/2"
Torque	30 {306}

## Flow Direction

Fluid must run from the intake port to the outlet ports. Please refer to the flow directions (arrows) on the \* Models and Dimensions. \*

## Interchangeability

Interchangeable with plugs of HI CUPLA models 10, 17, 20, 30 and 40. Interchangeable with each models of NUT CUPLA series and HI CUPLA series. Please see page 21 for "HI CUPLA Series Interchangeability".

## Minimum Cross-Sectional Area

(mm<sup>2</sup>)

Min. cross-sectional area	41
---------------------------	----

## Suitability for Vacuum

Not suitable for vacuum application in either connected or disconnected condition.

## Pressure - Flow Characteristics

[Test conditions] - Fluid : Air

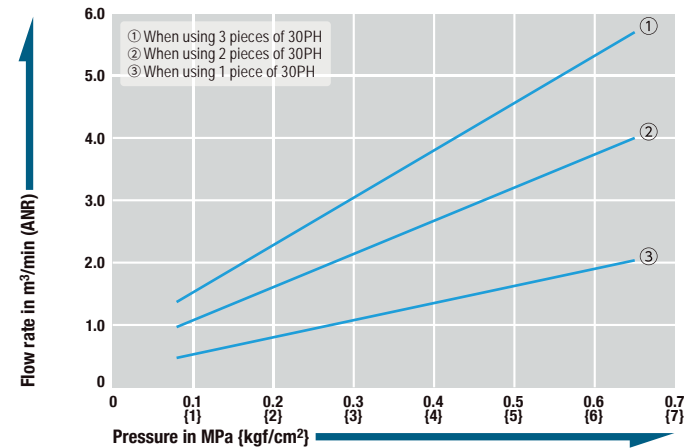

## Models and Dimensions

WAF : WAF stands for width across flats.

### Socket RE-PV-30 type (For three outlets)

Mass : 1090 g

• Fluid must run in the direction of the arrow.

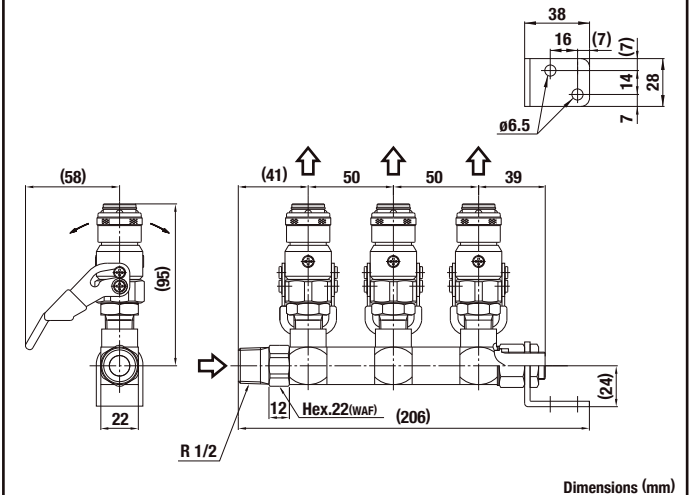



Dimensions (mm)



For Low Pressure (Air)

# ROTARY LINE CUPLA

Simple design air line couplings on free turn manifold

<p>Working pressure</p>  <p>1.5 MPa (15 kgf/cm<sup>2</sup>)</p>	<p>Valve structure</p>  <p>One-way shut-off</p>	<p>Applicable fluid</p>  <p>Air</p>
---	--	--

Each air outlet can be turned freely to any angle independently.

- Multiple outlets are available from single air supply source.
- Sideway air outlets are rotatable to any angle. Possible hose twists can be eliminated by the component couplings' swivel mechanism.
- Choose either RT type (2 outlets) or RE type (3 outlets) to suit your application.

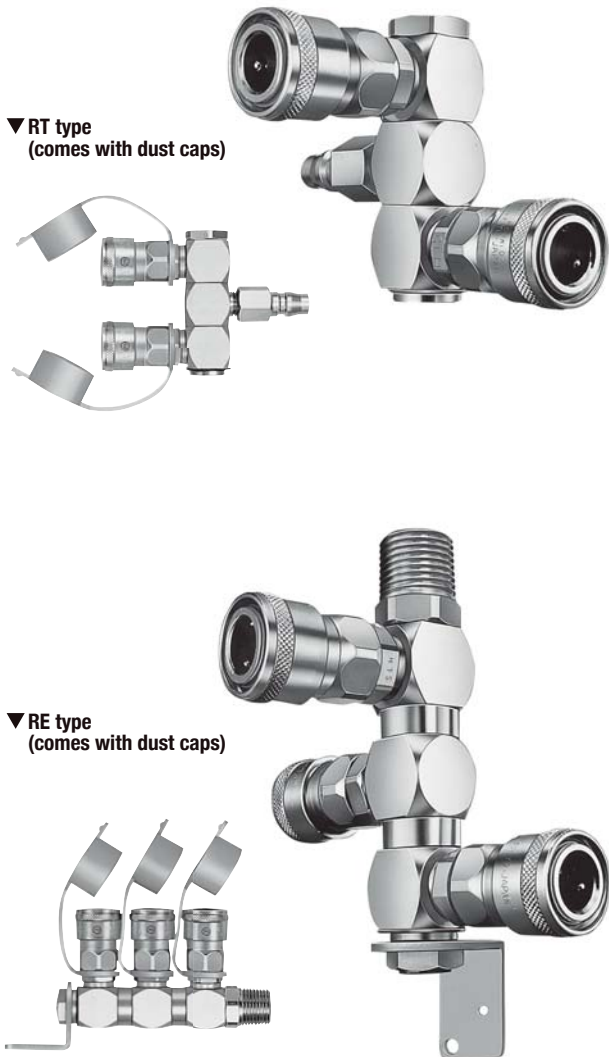

Specifications				
Body material	Body : Brass (Chrome plated), CUPLA : Steel (Chrome plated)			
Model	RT Type (for two branch lines)		RE Type (for three branch lines)	
Size	Inlet	HI CUPLA Plug 20PF	Inlet	R 1/2
	Outlet	2 sockets for HI CUPLA Socket Model 20		Outlet
Pressure unit	MPa	kgf/cm <sup>2</sup>	bar	PSI
Working pressure	1.5	15	15	218
Seal material	Seal material	Mark	Working temperature range	Remarks
Working temperature range *1	Nitrile rubber	NBR	-20 °C to +60 °C	Standard material

\* The products come with dustproof caps.  
\*1: The operable temperature range depends on the operating conditions.

Maximum Tightening Torque (RE Type)		Nm {kgf·cm}
Size (Thread)	1/2"	
Torque	30 {306}	

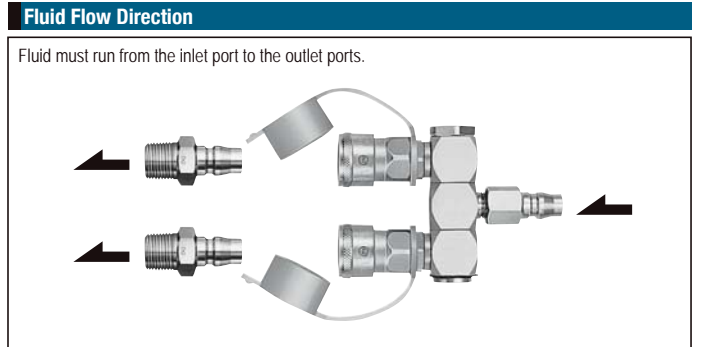

**Interchangeability**

Interchangeable with plugs of HI CUPLA models 10, 17, 20, 30 and 40.  
Interchangeable with each models of NUT CUPLA series and HI CUPLA series.  
Please see page 21 for "HI CUPLA Series Interchangeability".

Minimum Cross-Sectional Area (mm <sup>2</sup> )		
Model	RT type	RE type
Minimum cross-sectional area	33	

**Suitability for Vacuum**

Not suitable for vacuum application in either connected or disconnected condition.

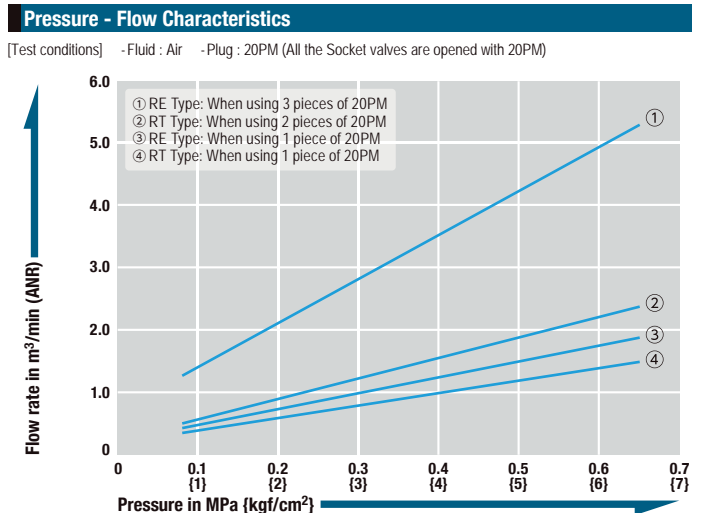

Models and Dimensions

**Socket RT type (For two outlets)**

Mass : 490 g

- Fluid must run in the direction of the arrow.
- The product comes with dust caps.

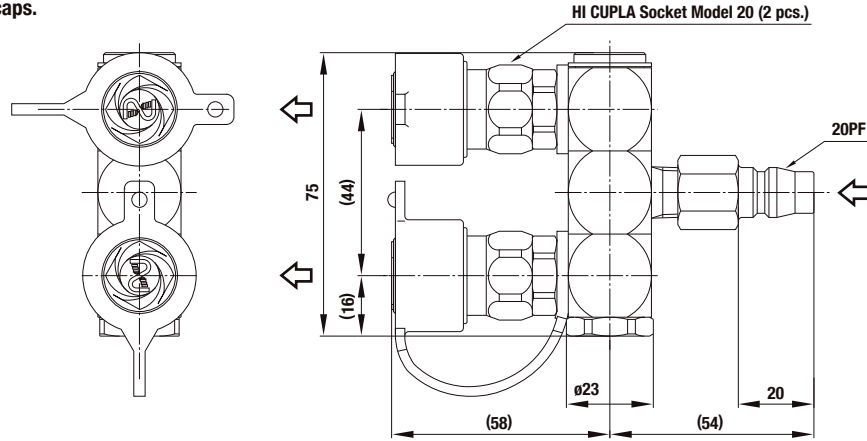

Dimensions (mm)

**Socket RE type (For three outlets)**

Mass : 660 g

- Fluid must run in the direction of the arrow.
- The product comes with dust caps.

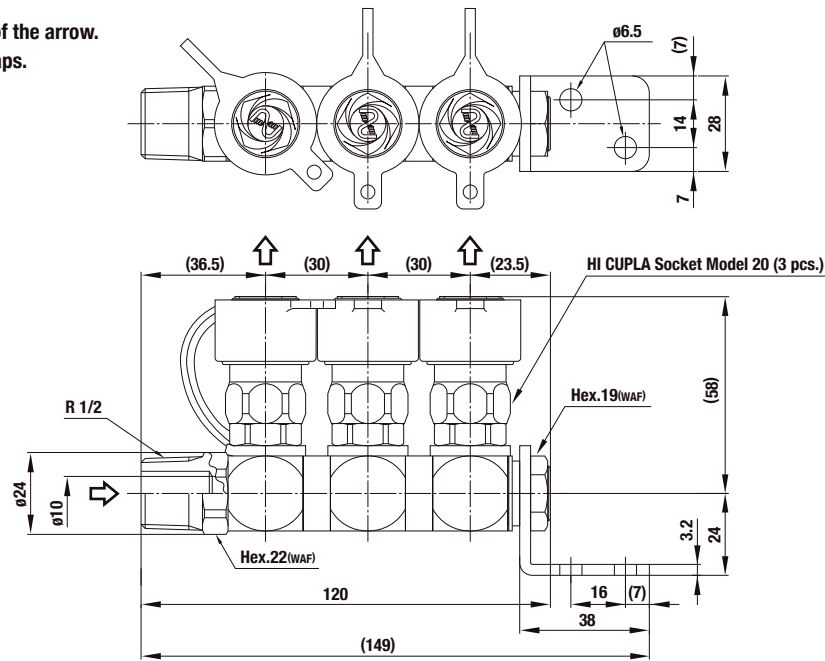

Dimensions (mm)

For Low Pressure (Air)

# LINE CUPLA

## 200T Type, 200L Type, 200S Type

Simple design air line coupling on manifold

Working pressure



Valve structure



Applicable fluid

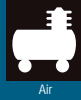

### Enables several air lines to be taken simultaneously from one supply line!

- Just push in the plug into socket for simple and secure connection.
- Multiple outlets are available from single air supply source.
- Choose from the 2-outlet type (Model 200T), the 5-outlet straight type (Model 200L) and the 5-outlet star type (Model 200S) to suit your application.



**200T type**  
(comes with dust caps)

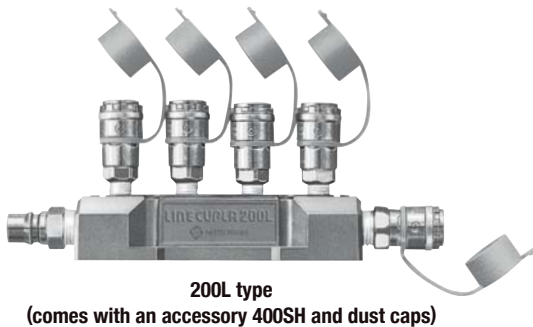

**200L type**  
(comes with an accessory 400SH and dust caps)



**200S type**  
(comes with an accessory 400SH and dust caps)

### Specifications

Body material	Body : Aluminum alloy, CUPLA : Steel (Chrome plated)			
Size	Inlet	200T Type : 20PM 200L Type / 200S Type : 400PM		
	Outlet	200T Type : 200-20SM 200L Type / 200S Type : 200-20SM, 200-40SM		
Pressure unit	MPa	kgf/cm <sup>2</sup>	bar	PSI
Working pressure	1.5	15	15	218
Seal material	Seal material	Mark	Working temperature range	Remarks
Working temperature range *1	Nitrile rubber	NBR	-20°C to +60°C	Standard material

- The products come with dustproof caps.

\*1: The operable temperature range depends on the operating conditions.

### Flow Direction

Fluid must run from the inlet port to the outlet ports.

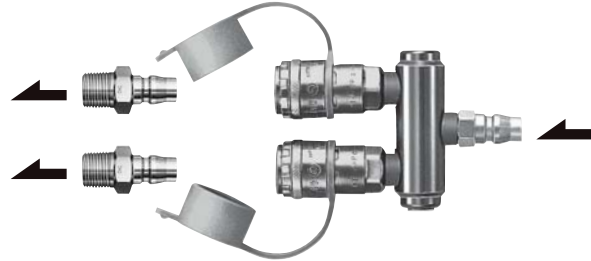

### Interchangeability

Interchangeable with plugs of HI CUPLA models 10, 17, 20, 30 and 40.

Interchangeable with each models of NUT CUPLA series and HI CUPLA series.

Please see [page 21](#) for "HI CUPLA Series Interchangeability".

### Minimum Cross-Sectional Area

(mm<sup>2</sup>)

Model	200T type, 200L type, 200S type
Minimum cross-sectional area	19

### Suitability for Vacuum

Not suitable for vacuum application in either connected or disconnected condition.

### Pressure - Flow Characteristics

[Test conditions] - Fluid : Air

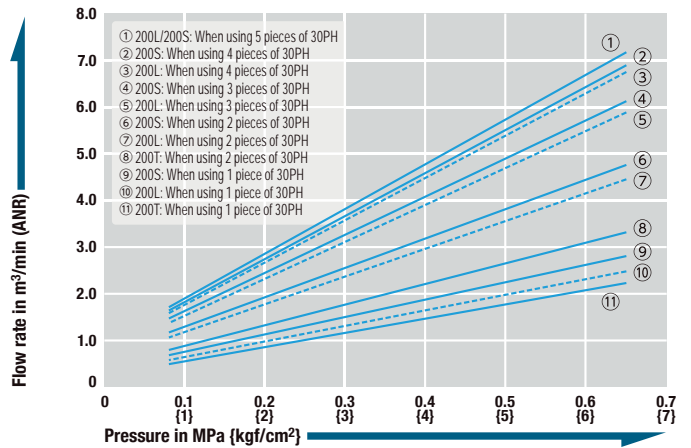

Models and Dimensions

**Socket 200T type (For two outlets)**

Mass : 272 g

- Fluid must run in the direction of the arrow.
- The product comes with dust caps.

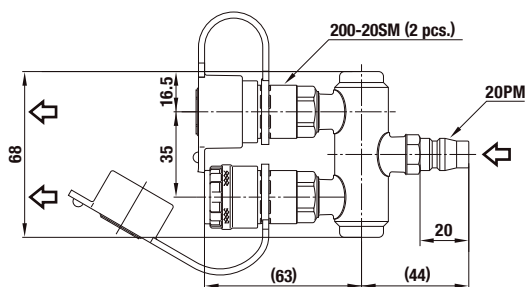

Dimensions (mm)

**Socket 200L type (For five outlets, in-line type)**

Mass : 890 g

- Fluid must run in the direction of the arrow.
- The product comes with dust caps.
- Accessory : 400SH

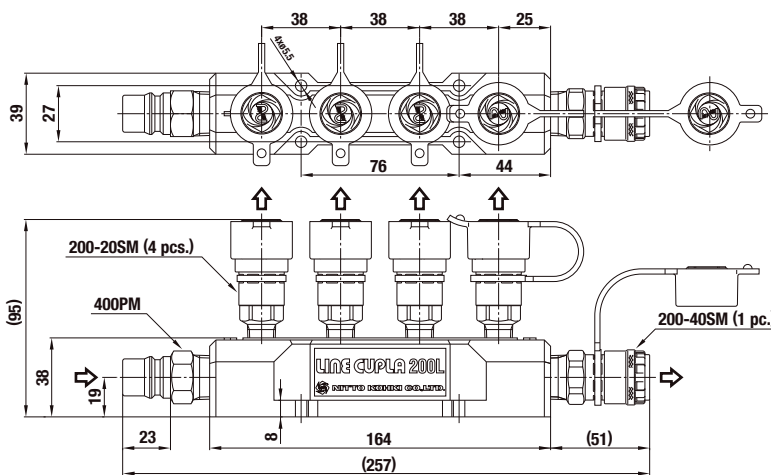

Dimensions (mm)

**Socket 200S type (For five outlets, star type)**

Mass : 769 g

- Fluid must run in the direction of the arrow.
- The product comes with dust caps.
- Accessory : 400SH

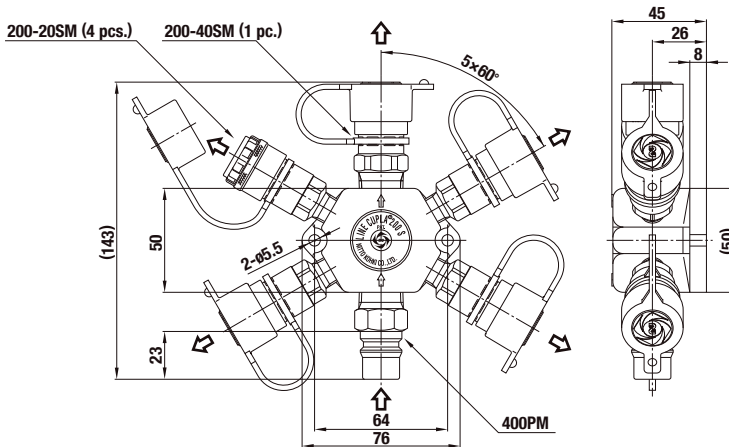

Dimensions (mm)

Application Example

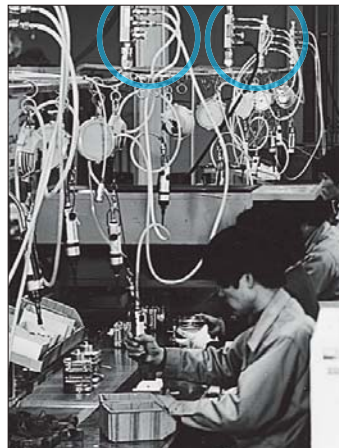

For Low Pressure (Air)

# ROTARY FULL BLOW LINE CUPLA

Free rotating branch air line coupling with low pressure loss & high flow rate

Working pressure <b>1.5</b> 1.5 MPa (15 kgf/cm <sup>2</sup> )	Valve structure  One-way shut-off	Applicable fluid  Air
--	---	-----------------------------

Each air outlet can be turned freely to any angle independently.

- Multiple outlets are available from single air supply source.
- Sideway air outlets are rotatable to any angle.
- Choose either RT type (2 outlets) or RE type (3 outlets) to suit your application.
- The flow rate increases by 40% to 50% over that of ROTARY LINE CUPLA RT type/RE type.
- During connection and disconnection, the valve is closed, enabling connection/disconnection under zero line pressure.
- When the sleeve of socket is returned to its original position, the purge mechanism releases the residual air pressure in the plug, eliminating unpleasant popping noise and hose whip motion on disconnection.
- Built-in separation prevention mechanism prevents accidental disconnection of CUPLA, ensuring safe operation.
- The valve can be opened and closed while the socket and plug is connected.

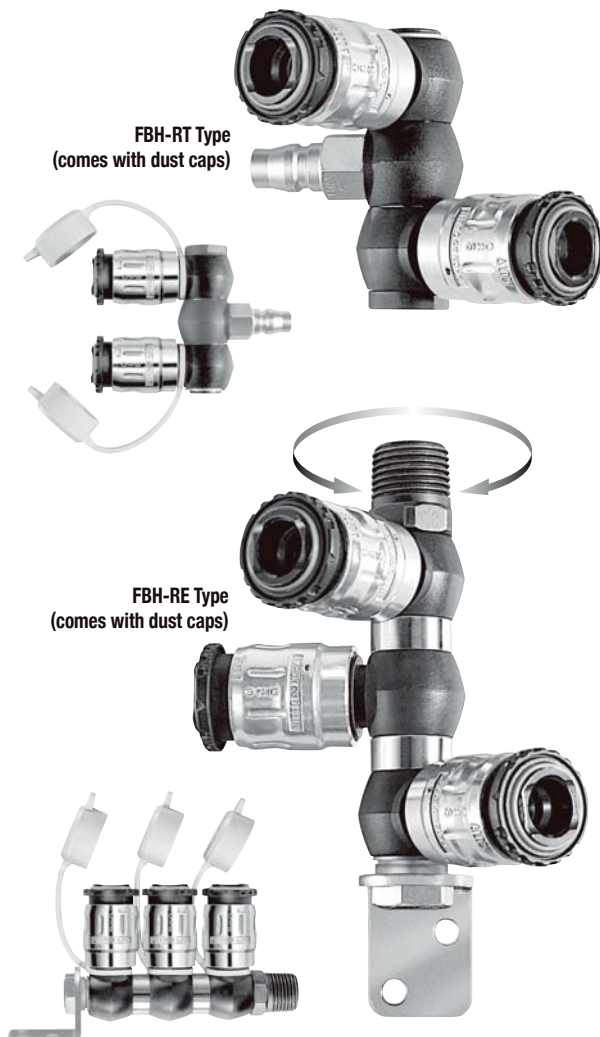

Specifications				
Body material	Zinc alloy			
Size	RT type (For two outlets)		RE type (For three outlets)	
	Inlet	Plug (20PFF)	Inlet	R 1/2
	Outlet	FULL BLOW CUPLA	Outlet	FULL BLOW CUPLA
Pressure unit	MPa	kgf/cm <sup>2</sup>	bar	PSI
Working pressure	1.5	15	15	218
Seal material	Seal material	Mark	Working temperature range	Remarks
Working temperature range <sup>*1</sup>	Nitrile rubber	NBR	-20 °C to +60 °C	Standard material

\* The products come with dustproof caps.

\*1: The operable temperature range depends on the operating conditions.

Maximum Tightening Torque (FBH-RE Type)		Nm {kgf·cm}
Size (Thread)	1/2"	
Torque	30 {306}	

### Flow Direction

Fluid must run from the inlet port to the outlet ports.

### Interchangeability

Interchangeable with plugs of HI CUPLA models 10, 17, 20, 30 and 40.  
Interchangeable with each models of NUT CUPLA series and HI CUPLA series.  
Not interchangeable with some plugs of plastic HI CUPLA 250 (discontinued product).  
Please see page 21 for "HI CUPLA Series Interchangeability".

Minimum Cross-Sectional Area (mm <sup>2</sup> )		
Model	FBH-RT	FBH-RE
Minimum cross-sectional area	44	44

### Suitability for Vacuum

Not suitable for vacuum application in either connected or disconnected condition.

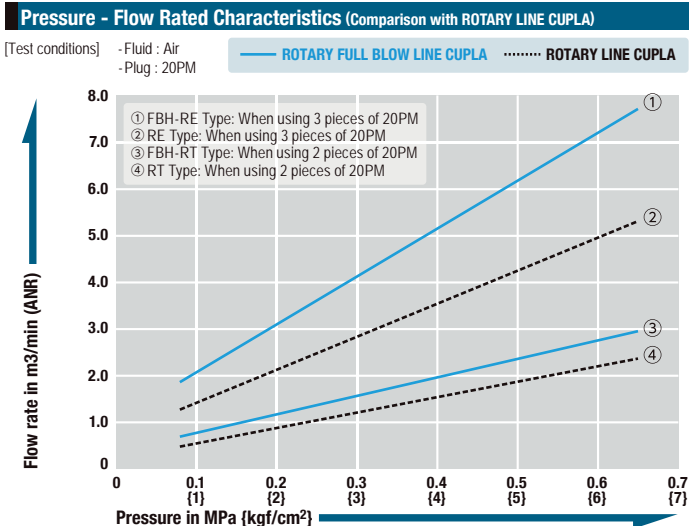



Models and Dimensions

**Socket FBH-RT type (For two branch lines)**

- Inlet : 1/4" HI CUPLA (20PFF)
- Outlet : FULL BLOW CUPLA (2 pcs.)
- Mass : 358 g
- Fluid must run in the direction of the arrow.

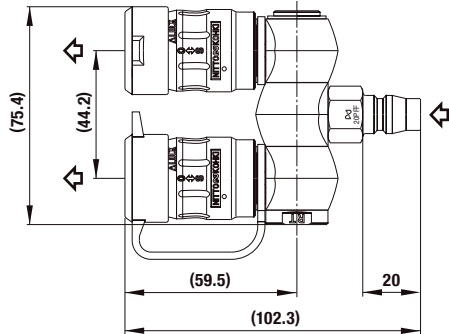

• The product comes with dust caps.

Dimensions (mm)

**Socket FBH-RE type (For three branch lines)**

- Inlet : R 1/2
- Outlet : FULL BLOW CUPLA (3 pcs.)
- Mass : 527 g
- Fluid must run in the direction of the arrow.

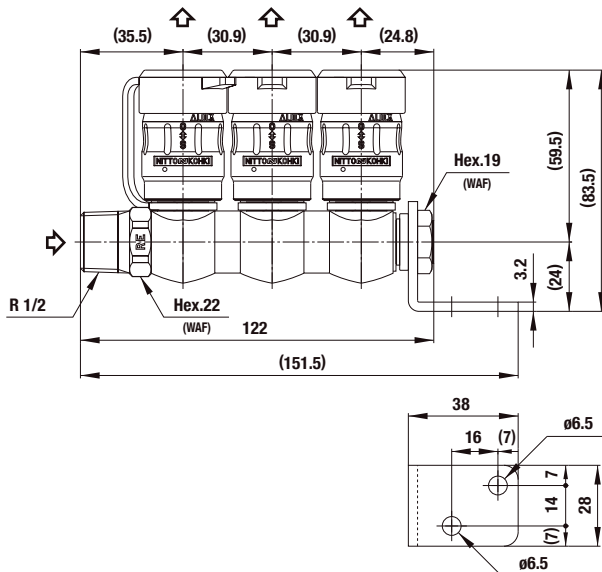

- The product comes with dust caps.

Dimensions (mm)

Features of ROTARY FULL BLOW LINE CUPLA

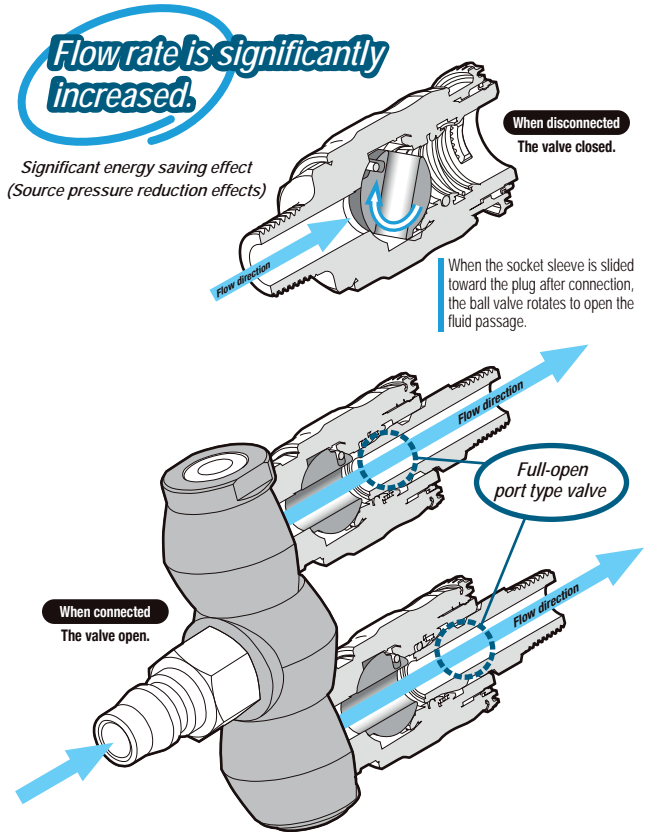

How It Works

1. Open the valve

Only after connection with the plug, you can slide the socket sleeve B toward the plug in order to open the built-in valve. Full flow path is then obtained.

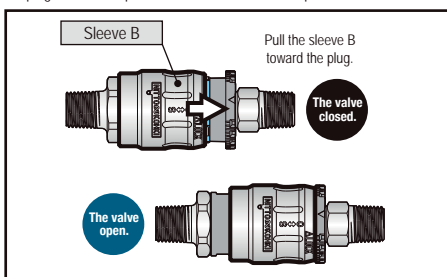

2. Lock the sleeve

Rotate the flange counterclockwise to lock the sleeve B. Without unlocking the plug you cannot disconnect.

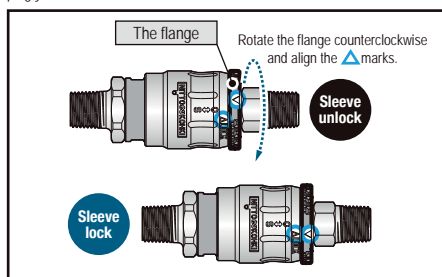

3. Purge the residual air

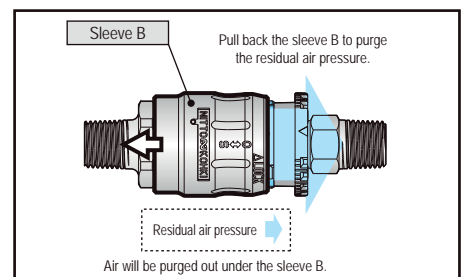

To disconnect the plug, first turn the flange back to its original position for unlocking and then pull the sleeve B back to the original position. The built-in valve will be closed to purge the residual air pressure.



For Low Pressure

# HI CUPLA ACE

Lightweight plastic coupling with separation prevention mechanism for air line applications

<b>Working pressure</b>	<b>Valve structure</b>	<b>Applicable fluids</b>
 1.5 MPa (15 kgf/cm <sup>2</sup> )	 One-way shut-off	 Air Water

The weight is merely a quarter of steel HI CUPLA's and smooth push-in connection is achieved. Separation prevention mechanism for safety operation.

- Pressure ratings comparable to steel CUPLA.
- A built-in separation prevention mechanism locks the sleeve upon connection, thus prevents accidental disconnection.
- Just push plug into socket for simple connection.
- The weight is a quarter of steel HI CUPLA for easy handling.
- Can be used for air and water.
- Air flows in either direction from plug or from socket side when coupled.
- Plug and socket with hose guard nut are also available (see page 68 of NK CUPLA HOSE/NK CUPLA COIL HOSE for details).



## Specifications

<b>Body material</b>		Engineering plastics (PBT, POM)		
<b>Size</b>	<b>Thread and hose barb</b>	1/4", 3/8" / 1/4", 3/8"		
	<b>PN type, SN type (PNG type, SNG type)</b>	For ø5 mm×ø8 mm, ø6 mm×ø9 mm, ø6.5 mm×ø10 mm, ø8 mm×ø12 mm, ø8.5 mm×ø12.5 mm polyurethane hose		
	<b>T type</b>	HA-T type · Inlet : 20P-PLA · Outlet : HA-65S		
<b>Working pressure</b>	<b>MPa</b>	1.5	1.0 for plastic plug and Model HA-T	
	<b>kgf/cm<sup>2</sup></b>	15	10 for plastic plug and Model HA-T	
	<b>bar</b>	15	10 for plastic plug and Model HA-T	
	<b>PSI</b>	218	145 for plastic plug and Model HA-T	
<b>Seal material</b>	<b>Seal material</b>	<b>Mark</b>	<b>Working temperature range</b>	<b>Remarks</b>
<b>Working temperature range</b> <sup>*1</sup>	Nitrile rubber	NBR	-20°C to +60°C	Standard material

\*1: The operable temperature range depends on the operating conditions.

## Tightening Torque Range

Model	Nm {kgf·cm}			
	20/30SM 20/30PM	50/60/65SN 50/60/65PN 50/65SNG 50/65PNG	80/85SN 80/85PN 85SNG 85PNG	20PFF
<b>Torque</b>	2.5 to 3.0 {26 to 31}	1.6 to 2.0 {16 to 20}	2.2 to 2.8 {22 to 29}	2.0 to 2.5 {20 to 25}

## Flow Direction

Fluid flow can be bi-directional when socket and plug are connected.



## Interchangeability

Interchangeable with HI CUPLA models 10, 17, 20, 30, 40 and 60.  
Interchangeable with each models of NUT CUPLA series and HI CUPLA series (except models 400, 600, and 800).  
Please see page 21 for "HI CUPLA Series Interchangeability".

## Suitability for Vacuum

Not suitable for vacuum application in either connected or disconnected condition.

## Pressure - Flow Characteristics

[Test conditions] - Fluid : Air

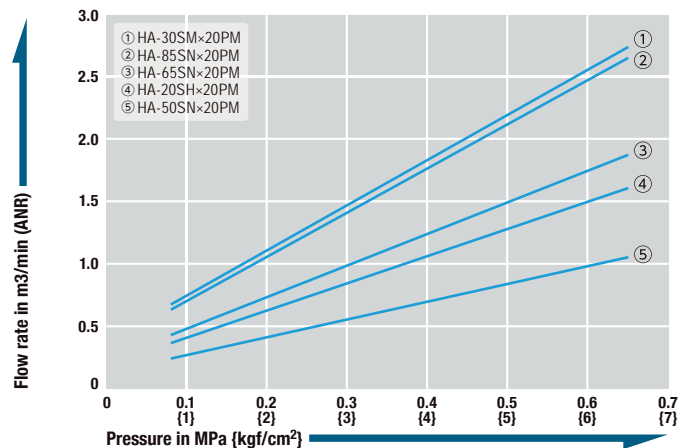

## Separation prevention mechanism

When the sleeve (Yellow color) is aligned to the lock position prior to connection, the sleeve will be locked to prevent accidental disconnection.

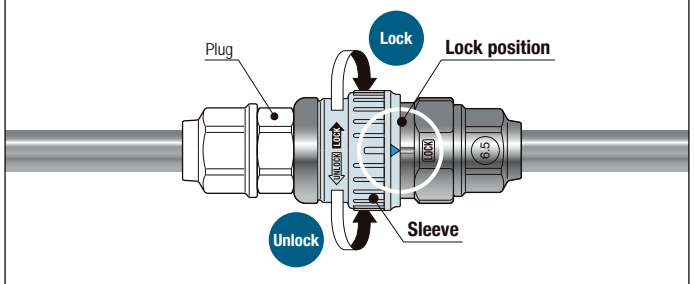

Models and Dimensions

**Plug PH type (Plastic plug / Hose barb)**

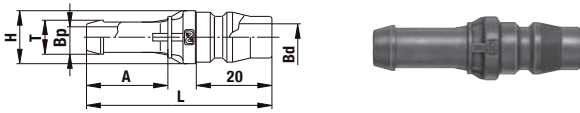

Model	Application (Hose)	Mass (g)	Dimensions (mm)					
			L	øH	A	øT	øBp	øBd
20PH-PLA	1/4"	3	49	14	21.5	9	5.5	7
30PH-PLA	3/8"	4	52	16	23.5	11.5	7.5	7

**Plug PM type (Plastic plug / Male thread)**

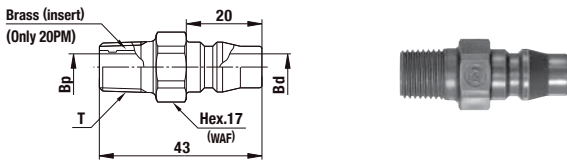

Model	Application (Thread)	Mass (g)	Dimensions (mm)		
			T	øBp	øBd
20PM-PLA	Rc 1/4	8	R 1/4	7.1	7.4
30PM-PLA	Rc 3/8	6	R 3/8	10	7.4

**Plug PN type (Plastic plug / For urethane hose connection)**

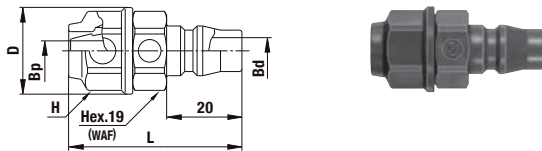

Model	Application (Hose)	Mass (g)	Dimensions (mm)				
			L	øH	Hp(WAF)	øBp	øBd
50PN-PLA	ø5 mm×ø8 mm	9	(46)	23	Hex.19	4	7
60PN-PLA	ø6 mm×ø9 mm	9	(46)	23	Hex.19	4.7	7
65PN-PLA	ø6.5 mm×ø10 mm	9	(46)	23	Hex.19	5.3	7
80PN-PLA	ø8 mm×ø12 mm	12	(48.5)	26	Hex.22	6.5	7
85PN-PLA	ø8.5 mm×ø12.5 mm	12	(48.5)	26	Hex.22	7	7

**Plug PPF type (Plastic plug / Parallel female thread)**

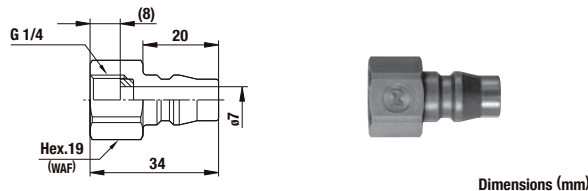

Model	Application (Thread)	Mass (g)
20PPF-PLA	G 1/4	6

**Plug PNG type (Plastic plug / For hose with hose guard nut connection)**

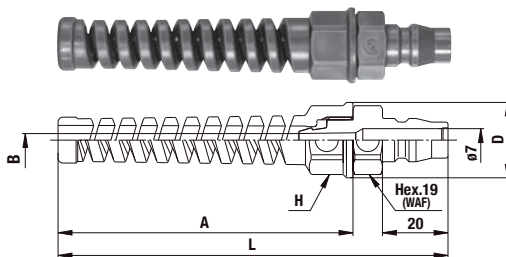

Model	Application (Hose)	Mass (g)	Dimensions (mm)				
			L	øD	H(WAF)	A	øB
50PNG-PLA	ø5 mm×ø8 mm	14	(119)	23	Hex.19	(90)	4
65PNG-PLA	ø6.5 mm×ø10 mm	15	(119)	23	Hex.19	(90)	5.3
85PNG-PLA	ø8.5 mm×ø12.5 mm	17	(119)	26	Hex.22	(90)	7

**Socket SH type (Hose barb)**

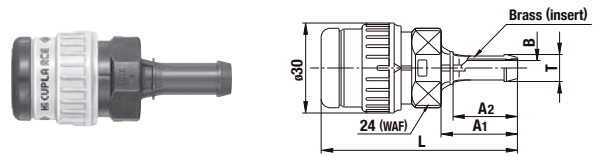

Model	Application (Hose)	Mass (g)	Dimensions (mm)				
			L	A1	A2	øT	øB
HA-20SH	1/4"	26	(65.5)	25.5	21.5	9	5
HA-30SH	3/8"	28	(68)	28	23.5	11.5	7

**Socket SM type (Male thread)**

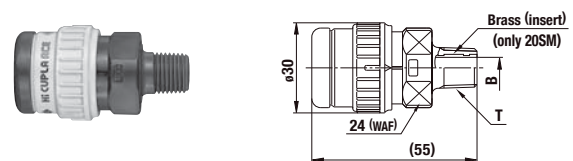

Model	Application (Thread)	Mass (g)	Dimensions (mm)	
			T	øB
HA-20SM	Rc 1/4	27	R 1/4	7.1
HA-30SM	Rc 3/8	26	R 3/8	8

**Socket SN type (For urethane hose connection)**

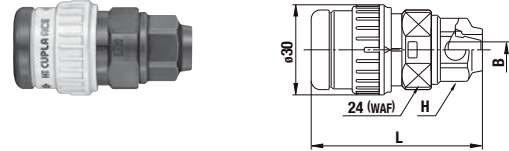

Model	Application (Hose)	Mass (g)	Dimensions (mm)		
			L	H(WAF)	øB
HA-50SN	ø5 mm×ø8 mm	27	(57)	Hex.19	4
HA-60SN	ø6 mm×ø9 mm	27	(57)	Hex.19	4.7
HA-65SN	ø6.5 mm×ø10 mm	27	(57)	Hex.19	5.3
HA-80SN	ø8 mm×ø12 mm	29	(59.5)	Hex.22	6.5
HA-85SN	ø8.5 mm×ø12.5 mm	29	(59.5)	Hex.22	7

**Socket T type (For two branch lines)**

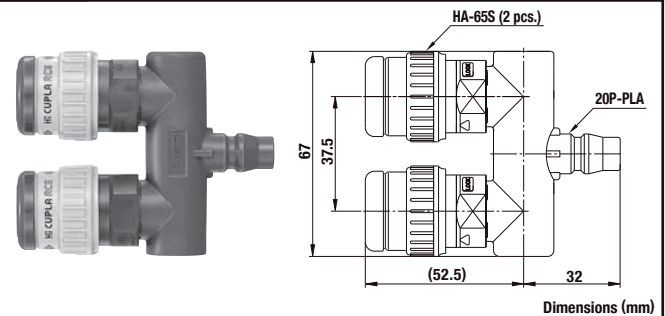

Model	Inlet / Outlet	Mass (g)
HA-T	20P-PLA / HA-65S (2 pcs.)	73

**Socket SNG type (For hose with hose guard nut connection)**

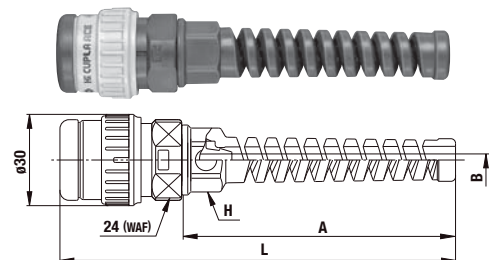

Model	Application (Hose)	Mass (g)	Dimensions (mm)			
			L	H(WAF)	A	øB
HA-50SNG	ø5 mm×ø8 mm	31	(130)	Hex.19	(90)	4
HA-65SNG	ø6.5 mm×ø10 mm	33	(130)	Hex.19	(90)	5.3
HA-85SNG	ø8.5 mm×ø12.5 mm	35	(130)	Hex.22	(90)	7

For Low Pressure (Air)

# ROTARY PLUG

For pneumatic tools and devices

Working pressure <b>1.5</b> 1.5 MPa (15 kgf/cm <sup>2</sup> )	Valve structure  One-way shut-off	Applicable fluid  Air
--	---	-----------------------------

**Rotary function allows 360° swivelling!**  
**Big improvement for handling of pneumatic tools!**

- Rotary neck plug for hose connection to pneumatic tools and pneumatic devices.
- Fits at 45° angle to the tool eliminating annoying offset load caused by connected hose.
- Ideal compact design enables optimum workability by simple body structure. Now far lighter and smaller than conventional models.
- New dust-proof design for increased durability.
- For air tackers, nailers, impact wrenches and other pneumatic tools.

**Comparison by appearance**

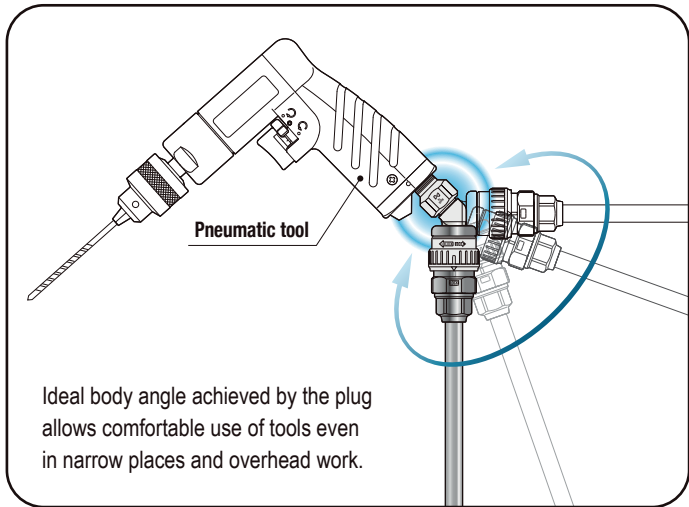
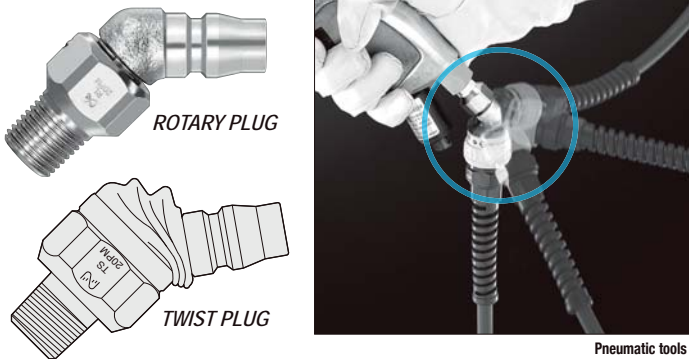

Specifications				
Body material	Steel (Nickel plated)			
Size (Thread)	1/4", 3/8"			
Pressure unit	MPa	kgf/cm <sup>2</sup>	bar	PSI
Working pressure	1.5	15	15	218
Seal material	Seal material	Mark	Working temperature range	Remarks
Working temperature range *1	Nitrile rubber	NBR	-20°C to +80°C	Standard material

\*1: The operable temperature range depends on the operating conditions.

Maximum Tightening Torque	Nm {kgf·cm}	
Size (Thread)	1/4"	3/8"
Torque	14 {143}	22 {224}

**Flow Direction**

Fluid flow can be bi-directional when socket and plug are connected.

**Interchangeability**

Interchangeable with sockets of HI CUPLA models 10, 17, 20, 30, 40 and 60. Interchangeable with each models of NUT CUPLA series and HI CUPLA series (except models 400, 600, and 800). Please see page 21 for "HI CUPLA Series Interchangeability".

Minimum Cross-Sectional Area	(mm <sup>2</sup> )		
Model	RL-20PM	RL-30PM	RL-20PFF
Minimum cross-sectional area	28	28	28

**Suitability for Vacuum**

Not suitable for vacuum application in either connected or disconnected condition.

**Models and Dimensions** WAF : WAF stands for width across flats.

**Plug PM type (Male thread)**

Model	Application (Thread)	Mass (g)	Dimensions (mm)		
			L	D	T
RL-20PM	Rc 1/4	52	(52.1)	(34.1)	R 1/4
RL-30PM	Rc 3/8	73	(50.8)	(32.8)	R 3/8

**Plug Model RL-20PFF type (Female thread)**

● Application (Thread) : G 1/4  
● Mass : 57 g

Dimensions (mm)



For Low Pressure (Air)

# TWIST PLUG

For pneumatic tools and devices

Working pressure <b>1.0</b> 1.0 MPa (10 kgf/cm <sup>2</sup> )	Valve structure  One-way shut-off	Applicable fluid  Air
--	---	-----------------------------

**Eliminates hose twisting, kinking, or bending! Greatly improves working efficiency!**

- A plug with a free twisting neck for hose connections to pneumatic tools and devices.
- Free angle control (max.70° flexible) provides comfortable job positions, even in narrow spaces or with overhead works.
- The flexible part is reinforced with self-lubricating plastics to give smooth bending action and excellent durability.
- Dust protector over the flexible part prevents dirt and swarf from entering.



Pneumatic tools

## Models and Dimensions

WAF : WAF stands for width across flats.

### Plug PM type (Male thread)

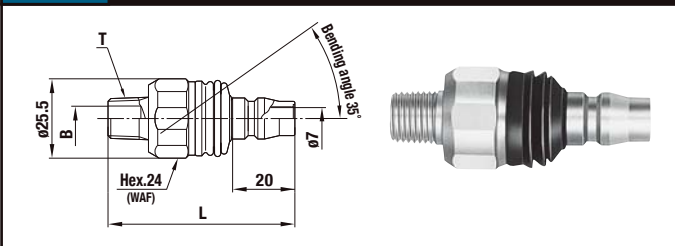

Model	Application (Thread)	Mass (g)	Dimensions (mm)		
			L	øB	T
TS-10PM	Rc 1/8	59	(57.5)	4	R 1/8
TS-20PM	Rc 1/4	59	(60)	8	R 1/4
TS-30PM	Rc 3/8	65	(60)	10	R 3/8

### Plug Model TS-20PFF (Female thread)

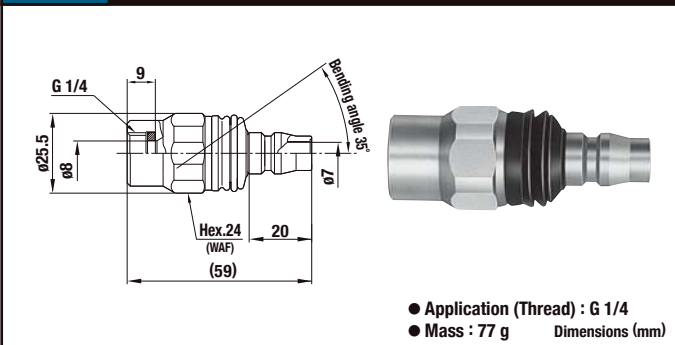

## Specifications

Body material	Steel (Nickel plated)			
Size (Thread)	1/8", 1/4", 3/8"			
Pressure unit	MPa	kgf/cm <sup>2</sup>	bar	PSI
Working pressure	1.0	10	10	145
Seal material	Seal material	Mark	Working temperature range	Remarks
Working temperature range *1	Nitrile rubber	NBR	-20°C to +60°C	Standard material

\*1: The operable temperature range depends on the operating conditions.

## Maximum Tightening Torque

Nm {kgf·cm}

Size (Thread)	1/8"	1/4"	3/8"
Torque	7 {71}	14 {143}	22 {224}

## Flow Direction

Fluid flow can be bi-directional when socket and plug are connected.



## Interchangeability

Interchangeable with sockets of HI CUPLA models 10, 17, 20, 30, 40 and 60.  
Interchangeable with each models of NUT CUPLA series and HI CUPLA series (except models 400, 600, and 800).  
Please see page 21 for "HI CUPLA Series Interchangeability".

## Suitability for Vacuum

Not suitable for vacuum application in either connected or disconnected condition.

## Minimum Cross-Sectional Area

(mm<sup>2</sup>)

Model	TS-10PM	TS-20PM	TS-30PM	TS-20PFF
Min. cross-sectional area	12.5	38.5	38.5	38.5

## Pressure - Flow Characteristics

[Test conditions] - Fluid : Air

(S) is a state of straight.  
(B) is a state of bending.

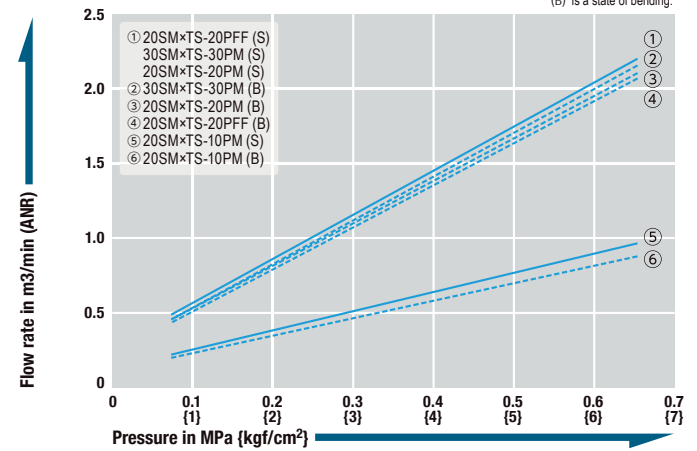





For Low Pressure (Air)

# PURGE PLUG

For air lines with purge mechanism

Working pressure <b>1.0</b> 1.0 MPa (10 kgf/cm <sup>2</sup> )	Valve structure  Purge valve	Applicable fluid  Air
--	---	--

**Eliminates unpleasant popping noise and hose whip motion when CUPLA is disconnected.**

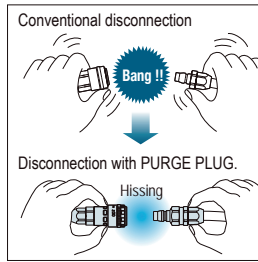

- When CUPLA is disconnected, the pressure left in the plug side hose is released gradually without unpleasant popping noise and hose whip motion.
- Unique design of air purge system enables the residual pressure release quickly and quietly.
- A unique but simple purge valve design is good for long and repeated use.
- The function is assured even under a high supply pressure or with a long hose.

Note: This product is not a check valve to totally stop the air flow.



Specifications				
Body material	Steel (Chrome plated)			
Size	1/4", 3/8", 1/2" / ø6.5 mm×ø10 mm, ø8.5 mm×ø12.5 mm hose			
Pressure unit	MPa	kgf/cm <sup>2</sup>	bar	PSI
Working pressure	1.0	10	10	145
Seal material	Seal material	Mark	Working temperature range	Remarks
Working temperature range *1	Nitrile rubber	NBR	-20°C to +60°C	Standard material

\*1: The operable temperature range depends on the operating conditions.

Tightening Torque Range		Nm {kgf·cm}
Torque	9 to 11 {92 to 112}	

To mount on urethane hose, slide it over to the hose barb and tighten the nut until it is flush against the hose barb base. It is recommended that grease GRE-M1 is applied to the inside of the nut (threaded part and hose contact part) for easy tightening.

**Flow Direction**

Fluid must run from socket to plug.

**Interchangeability**

Interchangeable with sockets of HI CUPLA models 10, 17, 20, 30, 40 and 60.  
Interchangeable with each models of NUT CUPLA series and HI CUPLA series (except models 400, 600, and 800). Please see page 21 for "HI CUPLA Series Interchangeability".

Minimum Cross-Sectional Area					(mm <sup>2</sup> )
Model	PV-20PH	PV-30PH	PV-40PH	PV-65PN	PV-85PN
Min. cross-sectional area	19.6	44.1	50.4	22.0	44.1

**Suitability for Vacuum**

Not suitable for vacuum application in either connected or disconnected condition.

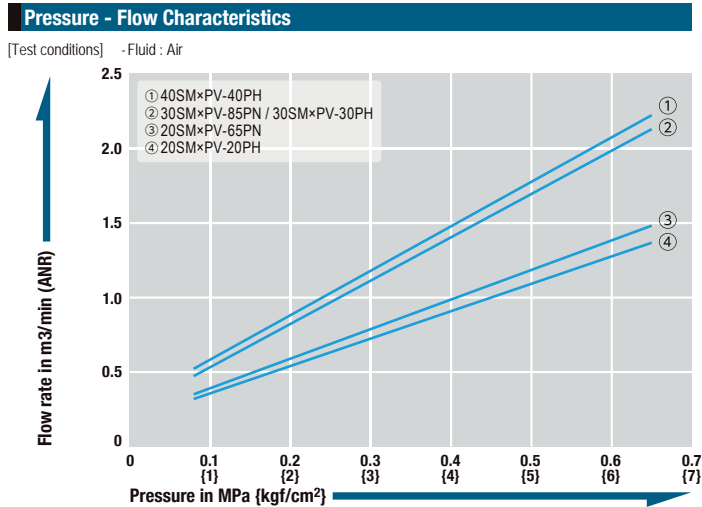

## Models and Dimensions

WAF: WAF stands for width across flats.

**Plug PH type (Hose barb)**

Model	Application (Hose)	Mass (g)	Dimensions (mm)			
			L	A	øB	øT
PV-20PH	1/4"	59	(70)	28	5	8.4
PV-30PH	3/8"	62	(74)	32	7.5	11.3
PV-40PH	1/2"	76	(77)	35	9	14.8



**Plug PN type (For urethane hose connection)**

Model	Application (Hose)	Mass (g)	Dimensions (mm)			
			L	A	øB	T(WAF)
PV-65PN	ø6.5 mm×ø10 mm	71	(59)	17	5.3	Hex.17
PV-85PN	ø8.5 mm×ø12.5 mm	78	(61)	19	7.5	Hex.19

# For Low Pressure (Air)

# ANTI-VIBRATION PLUG HOSE

Plug hose for vibrating and percussive air tools

Working pressure	Valve structure	Applicable fluid
 1.5 MPa (15 kgf/cm <sup>2</sup> )	 One-way shut-off	 Air

**Protects CUPLA from shock generated by vibrating tools and impact tools.**

- Optimizes life and prevents wear of “CUPLA” by absorbing strong shocks generated by connected vibrating tools.
- Prevents hard-to-notice flow reduction caused by “CUPLA” wear under continuous vibration.
- Flexible rubber hose allows free and wide range of tool motion.



Specifications				
Applicable fluid	Air			
Model	SHA-3-2R	SHA-3-3R		
Size (Thread)	R 1/4	R 3/8		
Inlet (Plug)	HI CUPLA Plug 30PH			
Pressure unit	MPa	kgf/cm <sup>2</sup>	bar	PSI
Working pressure	1.5	15	15	218
Air hose	Rubber hose for air			
Overall length	320 mm			
Minimum bend radius	135 mm			

Maximum Tightening Torque		Nm {kgf·cm}
Size (Thread)	R 1/4	R 3/8
Torque	14 {143}	22 {224}

**Interchangeability**  
Interchangeable with sockets of HI CUPLA models 10, 17, 20, 30, 40 and 60. Interchangeable with each models of NUT CUPLA series and HI CUPLA series (except models 400, 600, and 800). Please see page 21 for “HI CUPLA Series Interchangeability”.

**Application**

Suitable for air tools such as impact wrenches used in car maintenance or metalworking industries, and tackers, nailers or concrete breakers in the construction industry, that commonly cause incessant vibrations.

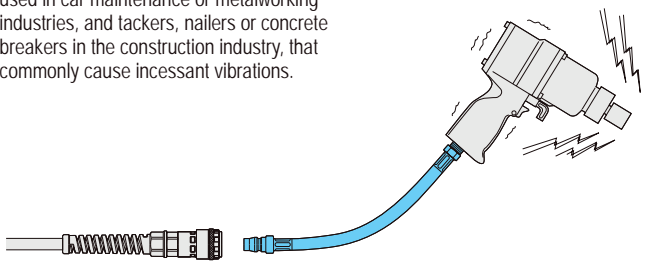

As an intermediate connection hose between “CUPLA” and a vibrating air tool.

For Low Pressure (Air)

# DUSTER CUPLA

Air line coupling with air blower function

Working pressure	Valve structure	Applicable fluid
1.0 MPa (10 kgf/cm <sup>2</sup> )	One-way shut-off	Air

## Three functions in one: connection, air blow, hose twist release! Dust blow without detaching the tool!

- HI CUPLA comes with compact air blow function.
- Improves job efficiency by air blow with tool still connected to hose.
- Ball bearing swivel mechanism prevents hose twist and relieves tension on operator's hand.
- Special design of air blow button switch is free from in line air pressure - no hard press down required.
- Also simple is routine water drain from air line before starting daily work.



Photo shows simulated air flow.

Specifications				
Body material	Body : Aluminum alloy, CUPLA : Steel (Chrome plated)			
Size	For 1/4", 3/8", 1/2" hose For ø6.5×ø10 mm, ø8.5×ø12.5 mm polyurethane hose			
Pressure unit	MPa	kgf/cm <sup>2</sup>	bar	PSI
Working pressure	1.0	10	10	145
Seal material	Seal material	Mark	Working temperature range	Remarks
Working temperature range <sup>*1</sup>	Nitrile rubber	NBR	-20°C to +60°C	Standard material

\*1: The operable temperature range depends on the operating conditions.

Tightening Torque Range		Nm {kgf·cm}	
Model	65PNG	85PNG	
Torque	5 to 6 (51 to 61)	7 to 8 (71 to 82)	

To mount on urethane hose, slide it over to the hose barb and tighten the nut until it is flush against the hose barb base. It is recommended that grease is applied to the inside of the nut (threaded part and hose contact part) for easy tightening.

### Flow Direction

Fluid must run from socket to plug.

### Interchangeability

Interchangeable with plugs of HI CUPLA models 10, 17, 20, 30, 40 and 60.  
Interchangeable with each models of NUT CUPLA series and HI CUPLA series.  
Please see page 21 for "HI CUPLA Series Interchangeability".

### Suitability for Vacuum

Not suitable for vacuum application in either connected or disconnected condition.

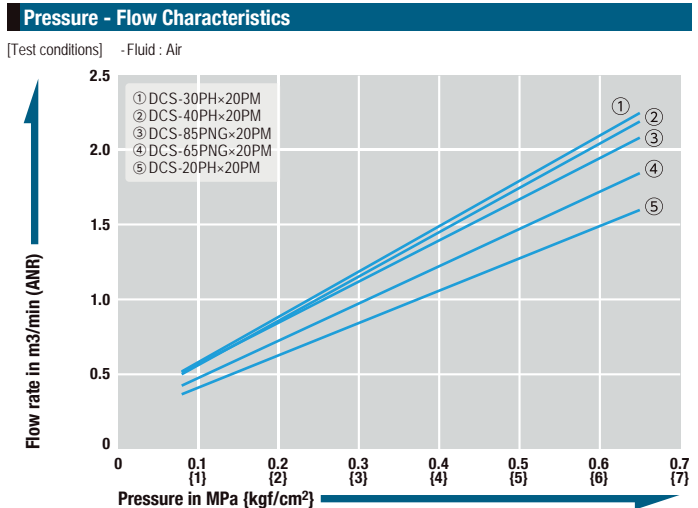

### Models and Dimensions

WAF : WAF stands for width across flats.

#### Socket PH type (Hose barb)

Model	Application (Hose)	Mass (g)	Dimensions (mm)				
			L	A	H	øB	øT
DCS-20PH	1/4"	168	(117.9)	30	40.5	5	9
DCS-30PH	3/8"	171	(121.9)	34	40.5	7.5	11.3
DCS-40PH	1/2"	193	(123.9)	36	40.5	7.5	15

#### Socket PNG type (For hose with hose guard nut connection)

Model	Application (Hose)	Mass (g)	Dimensions (mm)					
			L	A	H	øB	H(WAF)	T(WAF)
DCS-65PNG	ø6.5 mm×ø10 mm	176	(176.9)	90	40.5	5.3	Hex.17	Hex.19
DCS-85PNG	ø8.5 mm×ø12.5 mm	185	(176.9)	90	40.5	7.5	Hex.19	Hex.22

## For Low Pressure (Air)

# NK CUPLA HOSE with HI CUPLA ACE / FULL BLOW CUPLA NK CUPLA COIL HOSE with HI CUPLA ACE / FULL BLOW CUPLA

Couplings with polyurethane hose for air lines

Working pressure

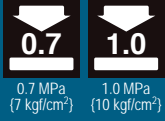

Valve structure



Applicable fluid



**HI CUPLA ACE and FULL BLOW CUPLA sockets with polyurethane hoses are now standard stock items. Push-to-connect design for quick piping.**

- Sockets of HI CUPLA ACE and FULL BLOW CUPLA comes with a spring nut that prevents hose bending and urethane hose with excellent flexibility, durability and wear resistance.
- Built-in separation prevention mechanism locks the sleeve upon connection, thus prevents accidental disconnection.
- Just push the plug into the socket for simple connection.
- Spiral polyurethane coil hoses processed from straight tube have self-recoiling feature.
- A Sleeve Cover is attached to "NK CUPLA HOSE/NK CUPLA COIL HOSE with FULL BLOW CUPLA", which reduces the impact on CUPLA and improves operability.

### Specifications

Name	NK CUPLA HOSE	NK CUPLA COIL HOSE	NK CUPLA HOSE	NK CUPLA COIL HOSE
CUPLA (Socket)	HI CUPLA ACE		FULL BLOW CUPLA	
Body material (Socket)	Engineering plastics (PBT, POM)		Aluminum alloy	
Body material (Plug)	Steel (Chrome plated)			
Hose Size	ø6.5×ø10	ø5×ø8	ø6.5×ø10	ø6.5×ø10
	ø8.5×ø12.5	ø6.5×ø10	ø8.5×ø12.5	
Working pressure	MPa	1.0	0.7	1.0
	kgf/cm <sup>2</sup>	10	7	10
	bar	10	7	10
	PSI	145	102	145
Seal material	Seal material		Mark	Working temperature range
Working temperature range <sup>1)</sup>	Nitrile rubber		NBR	-5°C to +60°C
				Remarks
				Standard material

<sup>1)</sup>: The operable temperature range depends on the operating conditions.

### Flow Direction

- With HI CUPLA ACE: Fluid flow can be bi-directional when socket and plug are connected.

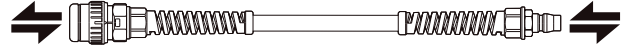

- With FULL BLOW CUPLA: Fluid must run from socket side to plug side of the hose.

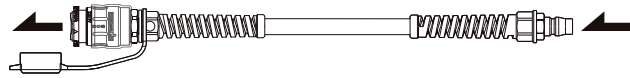

### Interchangeability

Interchangeable with HI CUPLA models 10, 17, 20, 30, 40 and 60.  
Interchangeable with each models of NUT CUPLA series and HI CUPLA series (except models 400, 600, and 800).  
Please see page 21 for "HI CUPLA Series Interchangeability".

### Suitability for Vacuum

Not suitable for vacuum application in either connected or disconnected condition.

### Models and Dimensions / Hose length

#### Plug / Socket NK CUPLA HOSE with HI CUPLA ACE



Model	Hose size	Hose length	Socket	Plug
			HI CUPLA ACE	NUT CUPLA
NKU-605B	ø6.5 mm×ø10 mm	5 m	HA-65SNG	65PNG
NKU-610B	ø6.5 mm×ø10 mm	10 m	HA-65SNG	65PNG
NKU-620B	ø6.5 mm×ø10 mm	20 m	HA-65SNG	65PNG
NKU-810B	ø8.5 mm×ø12.5 mm	10 m	HA-85SNG	85PNG
NKU-820B	ø8.5 mm×ø12.5 mm	20 m	HA-85SNG	85PNG

#### Plug / Socket NK CUPLA HOSE with FULL BLOW CUPLA



Model	Hose size	Hose length	Socket	Plug
			FULL BLOW CUPLA	NUT CUPLA
NKU-605P	ø6.5 mm×ø10 mm	5 m	FBH-65SNG	65PNG
NKU-610P	ø6.5 mm×ø10 mm	10 m	FBH-65SNG	65PNG
NKU-810P	ø8.5 mm×ø12.5 mm	10 m	FBH-85SNG	85PNG

#### Plug / Socket NK CUPLA COIL HOSE with HI CUPLA ACE



Model	Hose size	Maximum extensible length	Socket	Plug
			HI CUPLA ACE	NUT CUPLA
NKC-503B	ø5 mm×ø8 mm	2 m	HA-50SNG	50PNG
NKC-505B	ø5 mm×ø8 mm	4 m	HA-50SNG	50PNG
NKC-603B	ø6.5 mm×ø10 mm	2 m	HA-65SNG	65PNG
NKC-605B	ø6.5 mm×ø10 mm	4 m	HA-65SNG	65PNG

#### Plug / Socket NK CUPLA HOSE with FULL BLOW CUPLA



Model	Hose size	Hose length	Socket	Plug
			FULL BLOW CUPLA	NUT CUPLA
NKC-603P	ø6.5 mm×ø10 mm	2 m	FBH-65SNG	65PNG
NKC-605P	ø6.5 mm×ø10 mm	4 m	FBH-65SNG	65PNG



For Low Pressure

# MINI CUPLA

Standard type for use on equipment for welding and gas cutting, etc.

Working pressure: **0.7** MPa (7 kgf/cm<sup>2</sup>)

Valve structure: One-way shut-off

Applicable fluids: Oxygen, Fuel Gas

## Exclusively for oxyacetylene equipment. Many variations with higher flow rates!

- From cylinders to torches, all piping connections associated with welding and cutting equipment are push-to-connect operations.
- Double-lip seal prevents minor leak during connection. Oxygen and fuel gas CUPLA have different sizes to prevent accidental interconnection.
- Pressure loss is minimized to achieve higher flow rate.
- Various types of end configurations have been standardized to comply with a wide range of welding and cutting equipment applications. Sockets themselves or plugs themselves are interchangeable with MINI CUPLA SUPER's counterparts.
- LINE CUPLA MINI is also available for multiple piping.

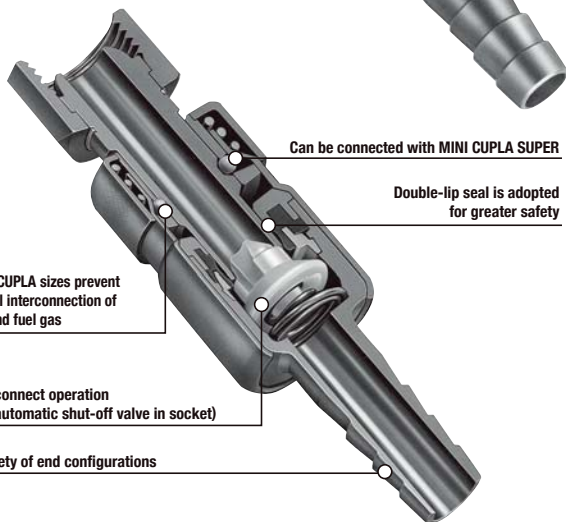

### Structure and Principle of Backflow Prevention

#### Plug with backflow stop valve (22PHB, 25PHB, 22PFB, 33PHB, 35PHB, 33PFB)

Plugs with backflow stop valve in MINI CUPLA are designed exclusively for gas welding/cutting to prevent occurrence of gas mixing. Possible backflow of gas during operation can be stopped by cutting the back flow into the cylinder or line. Such valve is adopted in both fuel gas and oxygen plug.

Cross-section sketch showing the structure

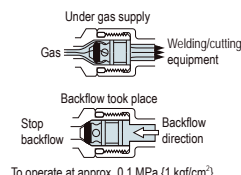
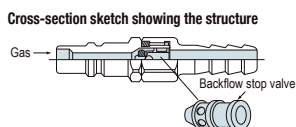

### Specifications

Body material	Brass			
Size	Thread	1/8", 1/4", 3/8" / M16, W12.5-20		
	Hose barb	1/4", 5/16", 3/8"		
Pressure unit	MPa	kgf/cm <sup>2</sup>	bar	PSI
Working pressure	0.7	7	7	102
Seal material	Seal material	Mark	Working temperature range	Remarks
Working temperature range <sup>*1</sup>	Nitrile rubber	NBR	-20 °C to +80 °C	Standard material

\*1: The operable temperature range depends on the operating conditions.

### Maximum Tightening Torque

Model	22PF, 22PFB, 22SF, 25PF, 33PF, 33PFB, 33SF	22SM	33SM
Torque	12 {122}	9 {92}	11 {112}

### Flow Direction



### Interchangeability

To prevent accidental connection, CUPLA for oxygen are not interchangeable with CUPLA for fuel gas. However, plugs and sockets for oxygen are interchangeable regardless of end configurations and plugs and sockets for fuel gas are interchangeable regardless of end configurations.

\*Interchangeable with MINI CUPLA SUPER.

### Minimum Cross-Sectional Area

		(mm <sup>2</sup> )									
For Oxygen		22PH	25PH	22PF	22PFF	25PF	22PHB	25PHB	22PFB	21PMT	22PMT
Socket	Plug										
22SH		19.6	19.6	19.6	19.6	19.6	15.9	15.9	15.9	19.6	19.6
25SH		19.6	19.6	19.6	19.6	19.6	15.9	15.9	15.9	19.6	19.6
22SF		19.6	19.6	19.6	19.6	19.6	15.9	15.9	15.9	19.6	19.6
22SM		19.6	19.6	19.6	19.6	19.6	15.9	15.9	15.9	19.6	19.6

### For Fuel Gas

		33PH	35PH	33PF	33PHB	35PHB	33PFB
Socket	Plug						
33SH		44.1	28.2	44.1	15.9	15.9	15.9
35SH		28.2	28.2	28.2	15.9	15.9	15.9
33SF		19.6	19.6	19.6	15.9	15.9	15.9
33SM		44.1	28.2	44.1	15.9	15.9	15.9

### Suitability for Vacuum

Not suitable for vacuum application in either connected or disconnected condition.

### Pressure - Flow Characteristics

[Test conditions] - Fluid : Air

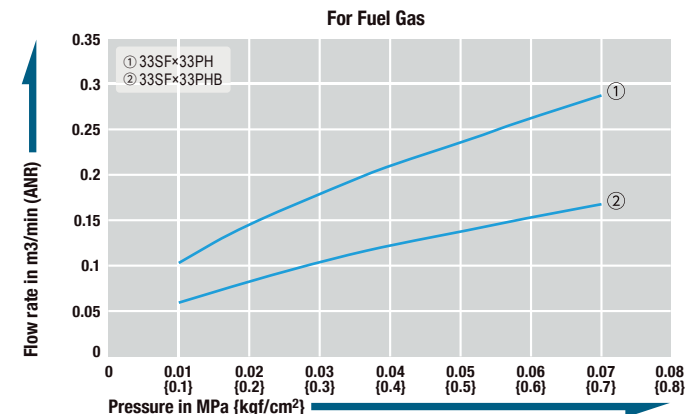
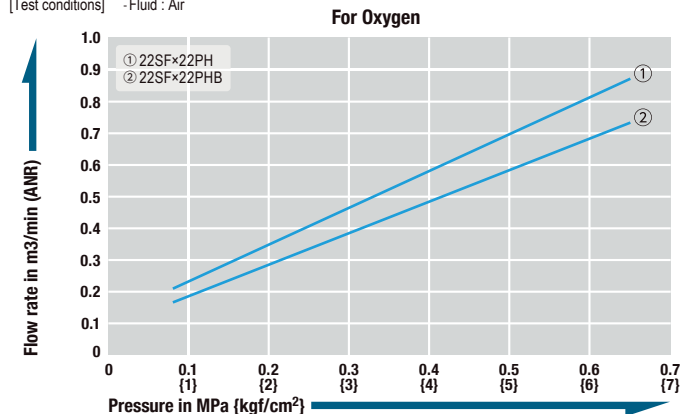



Models and Dimensions

**Plug PH type (Hose barb)**

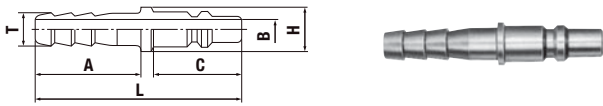

Usage	Model	Application (Hose)	Mass (g)	Dimensions (mm)					
				L	C	A	øH	øT	øB
For Oxygen	22PH	1/4"	16	55	23.5	28	11	7.8	5
	25PH	5/16"	19					9	
For Fuel Gas	33PH	3/8"	22	57	25.5	28	14	10.5	7.5
	35PH	5/16"	20					9	

**Socket SH type (Hose barb)**

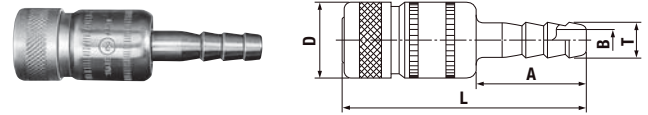

Usage	Model	Application (Hose)	Mass (g)	Dimensions (mm)					
				L	øD	A	øT	øB	
For Oxygen	22SH	1/4"	52	(65)	(19.8)	29	7.8	5	
	25SH	5/16"	55						9
For Fuel Gas	33SH	3/8"	69	(66)	(22.6)	29	10.5	7.5	
	35SH	5/16"	67				9		6

**Plug PF type (Female thread for torch connection)**

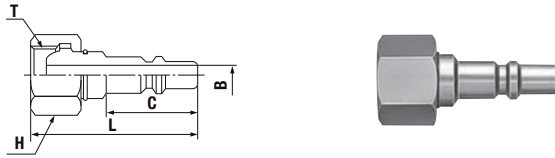

Usage	Model	Application (Thread)	Mass (g)	Dimensions (mm)					
				L	C	H(WAF)	T	øB	
For Oxygen	22PF	For oxygen torch side	31	(43)	23.5	Hex.19	M16×1.5	5	
	22PFF		29	(43.5)					G 1/4
	25PF		26						W12.5-20
For Fuel Gas	33PF	For fuel gas torch side	36	(44.5)	25.5	Hex.19	M16×1.5 left-hand thread	7.5	

**Socket SF type (Female thread for cylinder connection)**

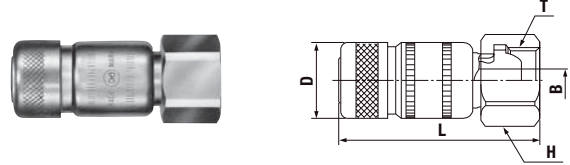

Usage	Model	Application (Thread)	Mass (g)	Dimensions (mm)					
				L	øD	T	øB	H(WAF)	
For Oxygen	22SF	For oxygen gauge side	80	(52)	(19.8)	M16×1.5	5	Hex.19	
For Fuel Gas	33SF	For fuel gas gauge side	96	(54)	(22.6)	M16×1.5 left-hand thread	5	Hex.19	

**Plug PHB type (Hose barb with backflow stop valve)**

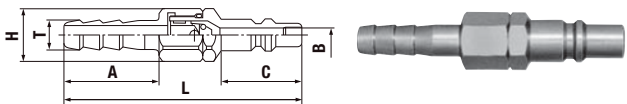

Usage	Model	Application (Hose)	Mass (g)	Dimensions (mm)					
				L	C	A	øH	øT	øB
For Oxygen	22PHB	1/4"	31	(69.6)	23.5	28	15.5	7.8	4.5
	25PHB	5/16"	34					9	
For Fuel Gas	33PHB	3/8"	41	(70.6)	25.5	28	15.5	10.5	4.5
	35PHB	5/16"	39					9	

**Socket SM type (Male thread)**

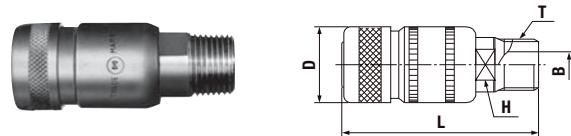

Usage	Model	Application (Thread)	Mass (g)	Dimensions (mm)					
				L	øD	H(WAF)	T	øB	
For Oxygen	22SM	Rc 1/4	51	(52)	(19.8)	12	R 1/4	7.5	
For Fuel Gas	33SM	Rc 3/8	77	(55)	(22.6)	14	R 3/8	10	

**Plug PFB type (Female thread with backflow stop valve for torch connection)**

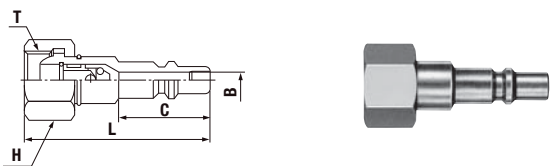

Usage	Model	Application (Thread)	Mass (g)	Dimensions (mm)					
				L	C	H(WAF)	T	øB	
For Oxygen	22PFB	For oxygen torch side	36	(48.5)	23.5	Hex.19	M16×1.5	4.5	
For Fuel Gas	33PFB	For fuel gas torch side	41	(49)	25.5	Hex.19	M16×1.5 left-hand thread	4.5	

**Plug PMT type (Male thread)**

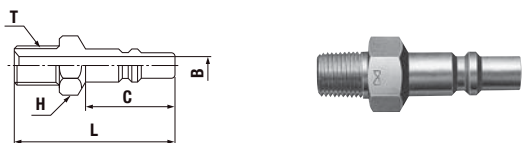

Usage	Model	Application (Thread)	Mass (g)	Dimensions (mm)					
				L	C	H(WAF)	T	øB	
For Oxygen	21PMT	Rc 1/8	22	43.5	24	Hex.14	R 1/8	5	
	22PMT	Rc 1/4	27	45	24	Hex.14	R 1/4	5	

**Socket LINE CUPLA MINI LM-32 (For three port branch piping)**

Mass : 4,300 g  
 • Dust caps come with the product as standard.

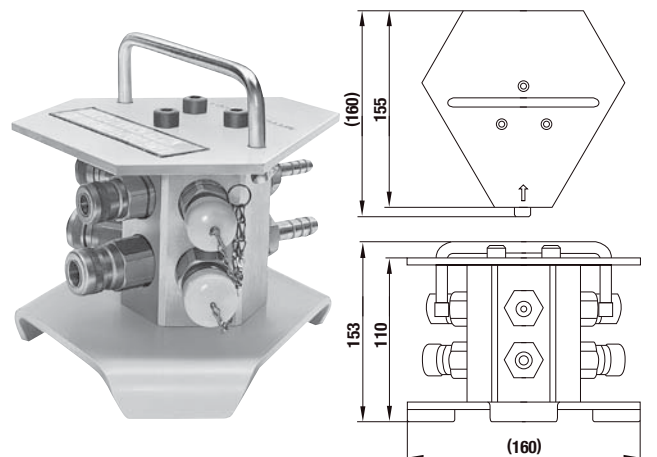

Dimensions (mm)			
LINE CUPLA MINI contains:	For Oxygen	For Fuel Gas	Qty
Supply port	1/4"	3/8"	Each 1 pc.
Gas outlets	22SM	33SM	Each 3 pc.
Accessories (Plug with backflow stop valve)	22PHB	33PHB	Each 3 pc.

For Low Pressure

# MINI CUPLA SUPER

Heavy-duty push-to-connect type for oxyacetylene piping

Working pressure **0.7** MPa (7 kgf/cm<sup>2</sup>)

Valve structure: One-way shut-off

Applicable fluids: Oxygen, Fuel Gas

## Exclusively for welding and cutting equipment.

- From cylinders to torches, all piping connections associated with welding and cutting equipment are push-to-connect operations.
- Plated body for better corrosion resistance.
- Heat-treated plugs for better durability.
- Oxygen and fuel gas CUPLA have different configuration sizes with sleeves in different appearances, silver colored plating for oxygen and copper colored plating for fuel gas, to prevent accidental interconnection.
- Smaller diameter design enables wider range of applications.
- Various types of end configurations have been standardized to comply with a wide range of welding and cutting equipment applications. Sockets themselves or plugs themselves are interchangeable with MINI CUPLA's counterparts.

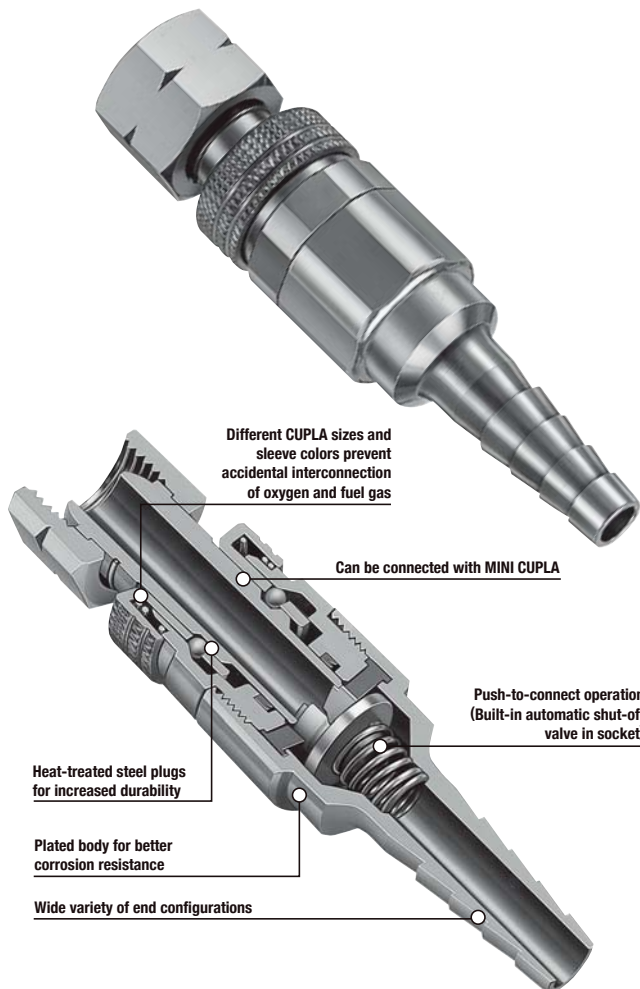

Specifications				
Body material	Socket : Brass (Chrome plated) Plug : Steel (Chrome plated)			
Size	Thread	1/4", 3/8", M16		
	Hose barb	1/4", 5/16", 3/8" / 5 mm ID		
Pressure unit	MPa	kgf/cm <sup>2</sup>	bar	PSI
Working pressure	0.7	7	7	102
Seal material	Seal material	Mark	Working temperature range	Remarks
Working temperature range <sup>1)</sup>	Nitrile rubber	NBR	-20°C to +80°C	Standard material

<sup>1)</sup> The operable temperature range depends on the operating conditions.

Maximum Tightening Torque		Nm {kgf·cm}	
Model	S22PF, S22SF, S33PF, S33SF	S22SM	S33SM
Torque	12 {122}	9 {92}	11 {112}

**Flow Direction**

Fluid must run from socket to plug.

**Interchangeability**

To prevent accidental connection, CUPLA for oxygen are not interchangeable with CUPLA for fuel gas. However, plugs and sockets for oxygen are interchangeable regardless of end configurations and plugs and sockets for fuel gas are interchangeable regardless of end configurations. Can be connected with MINI CUPLA series.

Minimum Cross-Sectional Area (mm <sup>2</sup> )	
For Oxygen	
Socket \ Plug	S22PH S225PH S22PF S22PN
S22SH	15.9 7.5 15.9 15.9
S225SH	7.5 7.5 7.5 7.5
S22SF	15.9 7.5 15.9 15.9
S22SM	15.9 7.5 15.9 15.9
S22SN	15.9 7.5 15.9 15.9

For Fuel Gas	
Socket \ Plug	S33PH S335PH S33PF S33PN
S33SH	28.2 7.5 28.2 15.9
S335SH	7.5 7.5 7.5 7.5
S33SF	28.2 7.5 28.2 15.9
S33SM	28.2 7.5 28.2 15.9
S33SN	15.9 7.5 15.9 15.9

**Suitability for Vacuum**

Not suitable for vacuum application in either connected or disconnected condition.

### Pressure - Flow Characteristics

[Test conditions] - Fluid : Air

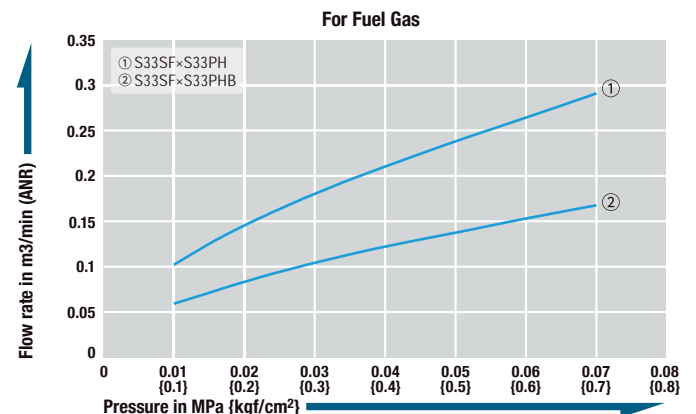
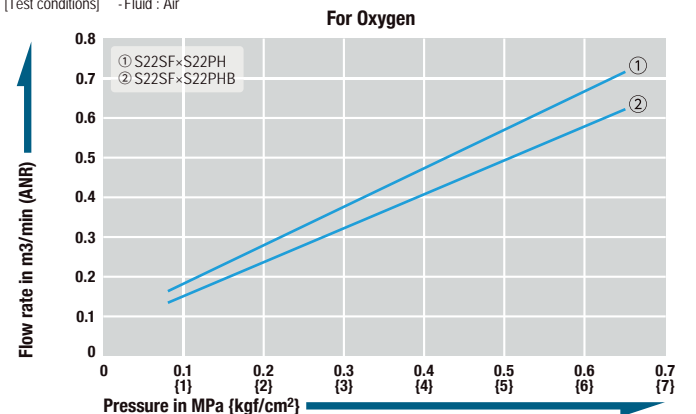

Models and Dimensions

**Plug PH type (Hose barb)**

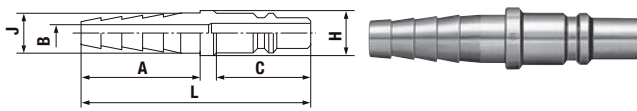

Usage	Model	Application (Hose)	Mass (g)	Dimensions (mm)					
				L	C	A	øH	øJ	øB
For Oxygen	S22PH	1/4", 5/16"	17	58	23.5	30	11	9.5	4.5
For Oxygen	S225PH	5 mm ID	12	49	23.5	21	11	6.2	3.1
For Fuel Gas	S33PH	5/16", 3/8"	22	59.5	25.5	30	14	11	6
For Fuel Gas	S335PH	5 mm ID	15	50.5	25.5	21	14	6.2	3.1

**Socket SH type (Hose barb)**

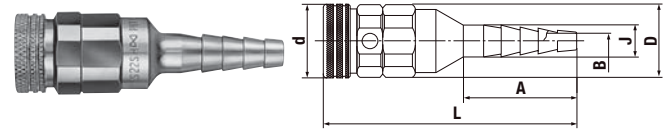

Usage	Model	Application (Hose)	Mass (g)	Dimensions (mm)					
				L	ød	øD	A	øJ	øB
For Oxygen	S22SH	1/4", 5/16"	50	(64.5)	(19.5)	20	30	9.5	4.5
For Oxygen	S225SH	5 mm ID	54	(62.5)	(19.5)	20	21	6.2	3.1
For Fuel Gas	S33SH	5/16", 3/8"	73	(68)	(22)	22	30	11	6
For Fuel Gas	S335SH	5 mm ID	65	(63)	(22)	22	21	6.2	3.1

**Plug PF type (Female thread for torch connection)**

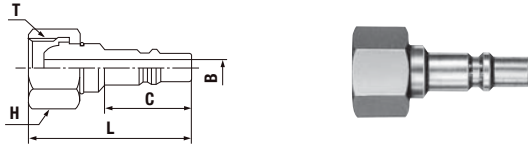

Usage	Model	Application (Thread)	Mass (g)	Dimensions (mm)				
				L	C	H(WAF)	T	øB
For Oxygen	S22PF	For oxygen torch side	35	(43)	23.5	Hex.19	M16×1.5	5
For Fuel Gas	S33PF	For fuel gas torch side	32	(44.5)	25.5	Hex.19	M16×1.5 left-hand thread	7.5

**Socket SF type (Female thread for cylinder connection)**

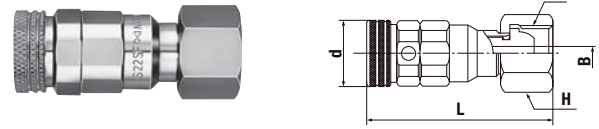

Usage	Model	Application (Thread)	Mass (g)	Dimensions (mm)				
				L	ød	øD	T	H(WAF)
For Oxygen	S22SF	For oxygen torch side	74	(52.5)	(19.5)	M16×1.5	Hex.19	4.5
For Fuel Gas	S33SF	For fuel gas torch side	97	(57.5)	(22)	M16×1.5 left-hand thread	Hex.19	6

**Plug PN type (Nut type for small diameter hose)**

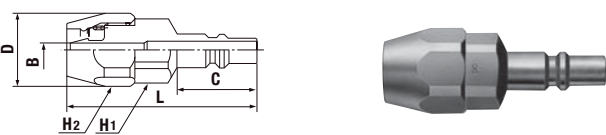

Usage	Model	Application (Hose)	Mass (g)	Dimensions (mm)					
				L	C	øD	H1(WAF)	H2(WAF)	øB
For Oxygen	S22PN	5 mm ID <sup>*1</sup>	54	(53.5)	23.5	20.5	Hex.17	Hex.19	4.5
For Fuel Gas	S33PN	5 mm ID <sup>*1</sup>	57	(54.5)	25.5	20.5	Hex.17	Hex.19	4.5

**Socket SM type (Male thread)**

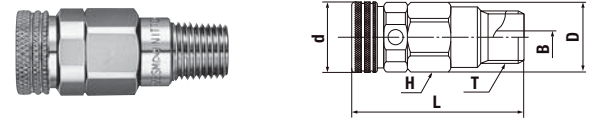

Usage	Model	Application (Thread)	Mass (g)	Dimensions (mm)					
				L	ød	øD	H(WAF)	T	øB
For Oxygen	S22SM	Rc 1/4	58	(48.5)	(19.5)	20	Hex.18	R 1/4	4.5
For Fuel Gas	S33SM	Rc 3/8	85	(52)	(22)	23	Hex.21	R 3/8	6

Select the combination in accordance with your own application.

Male thread	For regulator	For extension hose	For torch
Suggested combination SM×PH	Suggested combination SF×PH	Suggested combination SH×PH	Suggested combination SH×PF

**Socket SN type (Nut type for small diameter hose)**

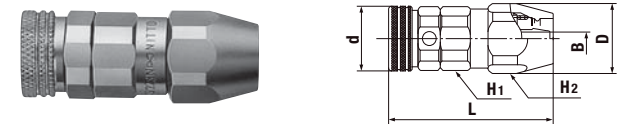

Usage	Model	Application (Hose)	Mass (g)	Dimensions (mm)					
				L	ød	øD	H1(WAF)	H2(WAF)	øB
For Oxygen	S22SN	5 mm ID <sup>*1</sup>	74	(52)	(19.5)	20.5	Hex.18	Hex.19	4.5
For Fuel Gas	S33SN	5 mm ID <sup>*1</sup>	91	(57)	(22)	20.5	Hex.21	Hex.19	4.5

\*1 : Available hose sizes are ø5 mm×ø11.2 mm, ø5 mm×ø11.5 mm and ø5 mm×ø11.8 mm.

Application Example



For Low Pressure

# MOLD CUPLA

General purpose and mold coolant port coupling

Working pressure



Valve structure



Applicable fluids



Designed for quick replacement for die and mold !  
Rust resistant models having many variations.

- Space saving design for molds with closely spaced coolant ports.
- Long sleeve socket facilitates connection/disconnection with plug embedded in mold.
- Enables quick mold cooling water line connection/disconnection.
- Various sizes and end configurations to suit a wide variety of mold applications.
- Can be connected with SUPER CUPLA, excluding K3 and K4 types.
- Push-to-connect design. (Built-in automatic shut-off valve in the socket) Also available is CUPLA without valve (Please specify in ordering).
- CUPLA for braided hose connection requires no hose clamp. (Model K-90SN)

For Braided Hose

Please use braided hoses available in the market.

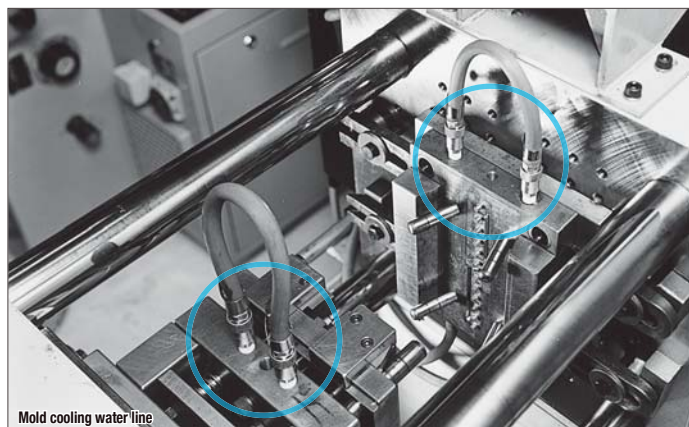
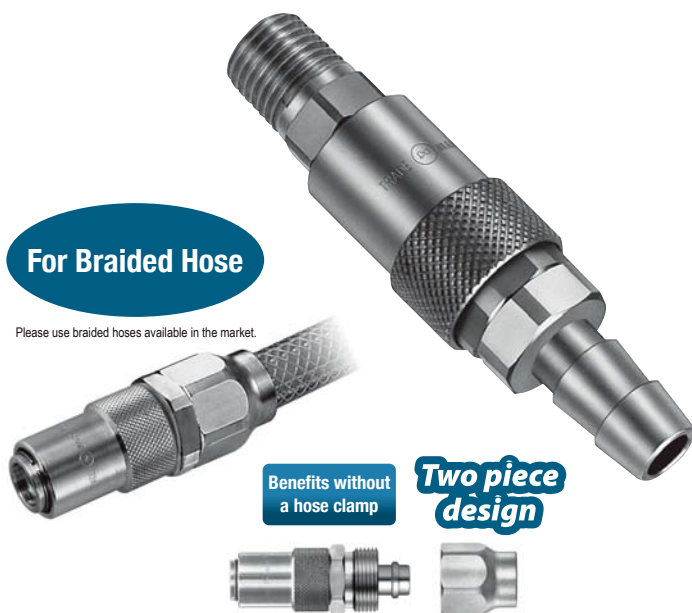

Mold cooling water line

## Specifications

Body material	Brass			
Size	Thread	1/8", 1/4", 3/8"		
	Hose barb	Hose: 1/4", 3/8" / Braided hose: $\phi 9 \text{ mm} \times \phi 15 \text{ mm}$		
Pressure unit	MPa	kgf/cm <sup>2</sup>	bar	PSI
Working pressure	1.0	10	10	145
Seal material	Seal material	Mark	Working temperature range	Remarks
	Nitrile rubber	NBR	-20 °C to +80 °C	Standard material
	Fluoro rubber	FKM	-20 °C to +180 °C	Available on request

- Maximum working pressure and working temperature range of CUPLA for braided hoses depend upon the specifications of braided hoses to be used.

\*1: The operable temperature range depends on the operating conditions.

## Maximum Tightening Torque

Nm {kgf·cm}

Size (Thread)	1/8"	1/4"	3/8"
Torque	5 {51}	9 {92}	11 {112}

Tighten the nut until it is flush against the hose barb base after pushing a braided hose to the end.

## Flow Direction

Fluid flow can be bi-directional when socket and plug are connected.



## Interchangeability

Sockets and plugs can be connected regardless of end configurations and sizes. K-0 series are not interchangeable with high flow type K3 and K4 series. Can be connected with SUPER CUPLA.

## Minimum Cross-Sectional Area

(mm<sup>2</sup>)

Socket	Plug														
	K-02SH	K-02TSH	K-03SH	K-03TSH	K-02SM	K-02TSM	K-03SM	K-03TSM	K-02SF	K-02TSF	K-02SHL	K-03SHL	K-03TSHL	K-90SN	
K-02PH	15.5	15.5	15.5	15.5	15.5	15.5	15.5	15.5	15.5	15.5	15.5	15.5	15.5	15.5	15.5
K-03PH	19	19	28	28	28	28	28	28	28	28	15.5	28	28	28	28
K-01PM	19	19	23	23	23	23	23	23	23	23	15.5	23	23	23	23
K-01PM-HH	19	19	23	23	23	23	23	23	23	23	15.5	23	23	23	23
K-02PM	19	19	28	28	28	28	28	28	28	28	15.5	28	28	28	28
K-02PM-HH	19	19	23	23	23	23	23	23	23	23	15.5	23	23	23	23
K-03PM	19	19	28	28	28	28	28	28	28	28	15.5	28	28	28	28
K-01PF	19	19	28	28	28	28	28	28	28	28	15.5	28	28	28	28
K-02PF	19	19	28	28	28	28	28	28	28	28	15.5	28	28	28	28
K-03PF	19	19	28	28	28	28	28	28	28	28	15.5	28	28	28	28
K-01PML	19	19	19	19	19	19	19	19	19	19	15.5	19	19	19	19
K-02PML	19	19	28	28	28	28	28	28	28	28	15.5	28	28	28	28
K-03PML	19	19	28	28	28	28	28	28	28	28	15.5	28	28	28	28

## Suitability for Vacuum

Not suitable for vacuum application in either connected or disconnected condition.

## Plug Embedment Dimensions

(mm)

Model	D*	C*	L	Remarks
K-01PM	20 or more	0 to 3	28	* Socket interference prevents connection/disconnection when C exceeds 3 mm.
K-01PM-HH	20 or more	0 to 3	24	
K-02PM	20 or more	0 to 3	29	* Size D should be bigger than the outer diameter of the socket wrench to be used. (See JISB4636-1, JISB4636-2)
K-02PM-HH	20 or more	0 to 3	24	
K-03PM	20 or more	0 to 3	30	

## Flow Rate – Pressure Loss Characteristics

[Test conditions] - Fluid : Water - Temperature : 23°C±5°C

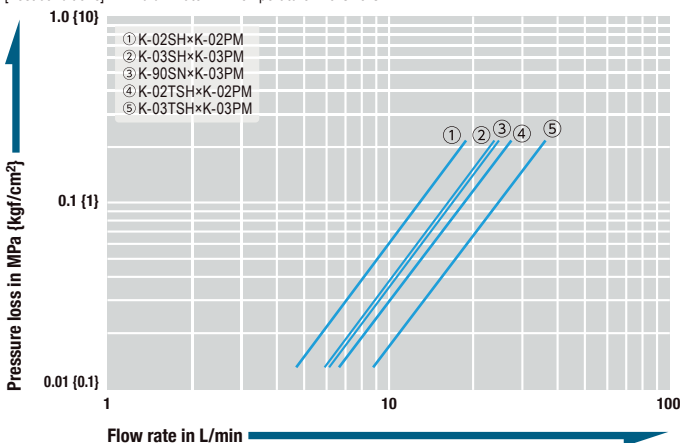



Models and Dimensions

**Plug PH type (Hose barb)**

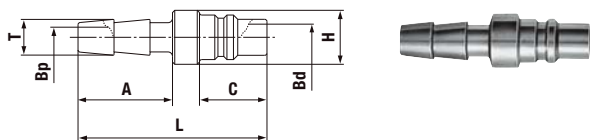

Model	Application (Hose)	Mass (g)	Dimensions (mm)						
			L	A	C	øH	øT	øBp	øBd
K-02PH	1/4"	17	42	21	15	12	8	4.5	6
K-03PH	3/8"	19	42	21	15	15	12	7	6

**Plug PM type (Male thread)**

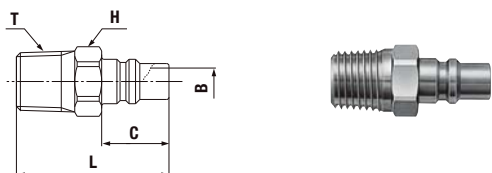

Model	Application (Thread)	Mass (g)	Dimensions (mm)				
			L	H(WAF)	C	T	øB
K-01PM	Rc 1/8	14	31	Hex.12	15	R 1/8	5.5
K-02PM	Rc 1/4	20	34	Hex.14	15	R 1/4	6
K-03PM	Rc 3/8	35	35	Hex.17	15	R 3/8	6

**Plug PF type (Female thread)**

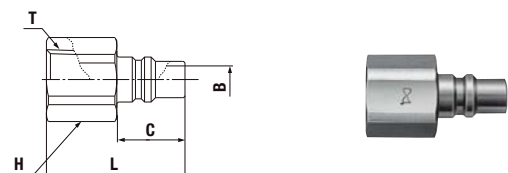

Model	Application (Thread)	Mass (g)	Dimensions (mm)				
			L	H(WAF)	C	T	øB
K-01PF	R 1/8	16	28	Hex.14	15	Rc 1/8	6
K-02PF	R 1/4	22	30.5	Hex.17	15	Rc 1/4	6
K-03PF	R 3/8	35	32	Hex.21	15	Rc 3/8	6

**Plug PML type (Male thread)**

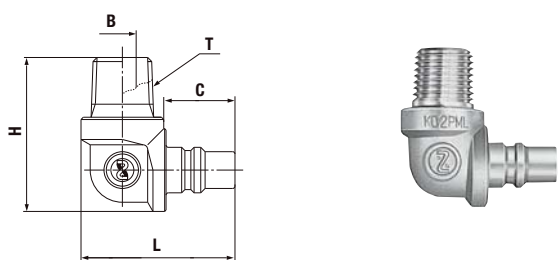

Model	Application (Thread)	Mass (g)	Dimensions (mm)				
			L	C	H	T	øB
K-01PML	Rc 1/8	43	33.5	15	30.5	R 1/8	5
K-02PML	Rc 1/4	53	33.5	15	33.5	R 1/4	6
K-03PML	Rc 3/8	71	33.5	15	33.5	R 3/8	6

**Plug PM-HH type (Male thread)**

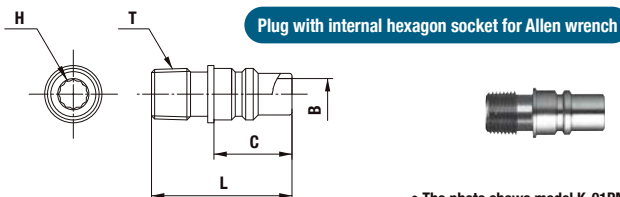

Model	Application (Thread)	Mass (g)	Dimensions (mm)					
			Outside Diameter	L	H	C	T	øB
K-01PM-HH	Rc 1/8	9	ø11	27	5	15	R 1/8	6
K-02PM-HH	Rc 1/4	15	(ø13.4)	29	5	15	R 1/4	6

**Socket SH type (Hose barb)**

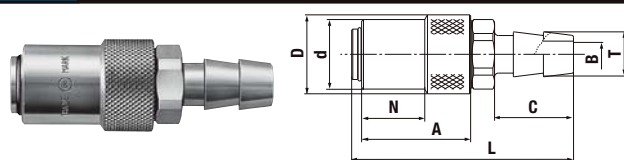

Model	Application (Hose)	Mass (g)	Dimensions (mm)							
			L	øD	ød	N	A	C	øT	øB
K-02SH	1/4	52	(67)	(21)	18.5	16.8	29	29	8	5
K-02TSH-1	1/4	52	(67)	(21)	18.5	16.8	29	29	8	5
K-03SH	3/8	60	(59)	(21)	18.5	16.8	29	21	12	7
K-03TSH-1	3/8	60	(59)	(21)	18.5	16.8	29	21	12	7

**Socket SM type (Male thread)**

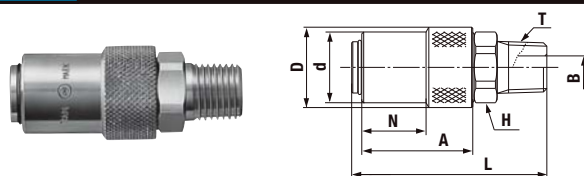

Model	Application (Thread)	Mass (g)	Dimensions (mm)							
			L	øD	ød	N	A	H(WAF)	T	øB
K-02SM	Rc 1/4	70	(51)	(21)	18.5	16.8	29	Hex.17	R 1/4	6
K-02TSM-1	Rc 1/4	70	(51)	(21)	18.5	16.8	29	Hex.17	R 1/4	6
K-03SM	Rc 3/8	82	(52)	(21)	18.5	16.8	29	Hex.19	R 3/8	6
K-03TSM-1	Rc 3/8	82	(52)	(21)	18.5	16.8	29	Hex.19	R 3/8	6

**Socket SF type (Female thread)**

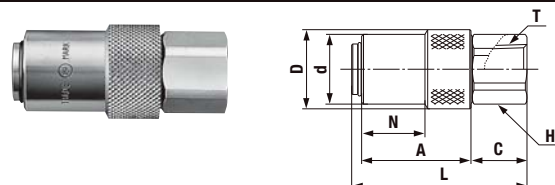

Model	Application (Thread)	Mass (g)	Dimensions (mm)							
			L	øD	ød	N	A	C	T	H(WAF)
K-02SF	R 1/4	57	(46.5)	(21)	18.5	16.8	29	14.5	Rc 1/4	Hex.17
K-02TSF-1	R 1/4	57	(46.5)	(21)	18.5	16.8	29	14.5	Rc 1/4	Hex.17

**Socket SHL type (Hose barb)**

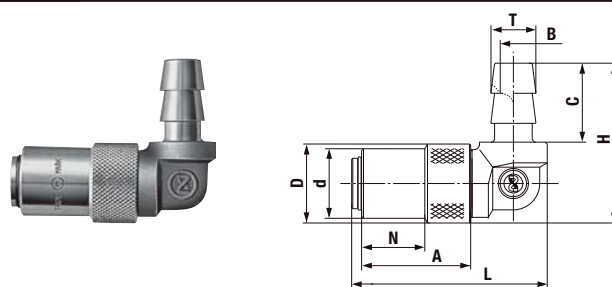

Model	Application (Hose)	Mass (g)	Dimensions (mm)								
			L	øD	ød	N	A	C	øT	H	øB
K-02SHL	1/4	79	(52)	(21)	18.5	16.8	29	21	8	(42.5)	4.5
K-03SHL	3/8	87	(52)	(21)	18.5	16.8	29	21	12	(42.5)	7
K-03TSHL-1	3/8	87	(52)	(21)	18.5	16.8	29	21	12	(42.5)	7

\*1: Also available without socket valve (Made-to-order item), identified by product code TS (e.g. K-03SH without valve is K-03TSH). Also available are sockets with separation prevention mechanism (Made-to-order item).

**Socket SN type (For braided hose connection)**

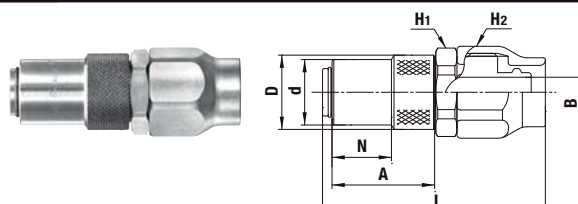

Model	Application (Hose)*		Mass (g)	Dimensions (mm)							
	Size (mm)	Hose wall thickness (mm)		L	øD	ød	N	A	H1(WAF)	H2(WAF)	øB
K-90SN	ø9×ø15	3±0.3	122	(63)	(21)	18.5	16.8	29	Hex.23	Hex.24	8.5





\* Braided hoses for SN type should be made of soft PVC and woven by reinforcement thread.



For Low Pressure

# MOLD CUPLA High Flow Type

High flow type mold coolant port coupling

<b>Working pressure</b>  1.0 MPa (10 kgf/cm <sup>2</sup> )	<b>Valve structure</b>  One-way shut-off	<b>Applicable fluids</b>   Water Heated oil
 Straight through		

## Flow rate has doubled\* to increase productivity.

\*Compared to our conventional model

- High flow type K3 and K4 series are added to MOLD CUPLA series for mold coolant and heated oil port coupling.
- Almost double flow rate compared with our standard K-01, K-02 and K-03 series, increasing productivity.
- Space saving design for molds with closely spaced coolant ports.
- Long sleeve socket facilitates connection/disconnection with plug embedded in mold.
- Enables quick mold coolant hose connection/disconnection.



### Results of reduced cooling time in the field

A customer replaced conventional K-0 series MOLD CUPLA with the K3 series and shortened the cooling time from 30 seconds to 21 seconds meaning an 18% reduction per shot and increased productivity by 20%, compared to the conventional models. Temperature checks at 8 positions on the mold (①~⑧ on the right picture) showed that surface temperatures on average had fallen by 3°C, providing evidence of the high cooling efficiency.

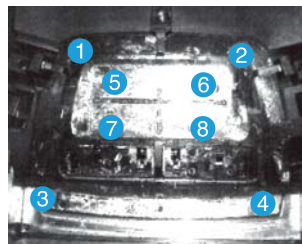

### Flow comparison

Coolant water flow rate was checked with a flow meter, which confirmed increase by 1.7 to 1.8 times, compared to the conventional models when MOLD CUPLA K3 series are used.



Conventional K-0 series MOLD CUPLA were used.

Increased by  
1.7 to 1.8 times UP

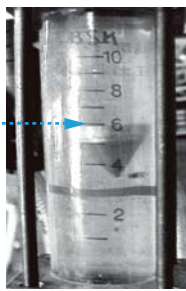

K3 series are used.

### Specifications

<b>Body material</b>		Brass			
<b>Size</b>	<b>Thread</b>	1/4", 3/8", 1/2"			
	<b>Hose barb</b>	3/8", 1/2" hose			
<b>Pressure unit</b>	<b>MPa</b>	<b>kgf/cm<sup>2</sup></b>	<b>bar</b>	<b>PSI</b>	
<b>Working pressure</b>	1.0	10	10	145	
<b>Seal material</b> <b>Working temperature range</b> <sup>*1</sup>	<b>Seal material</b>	<b>Mark</b>	<b>Working temperature range</b>	<b>Remarks</b>	
	Nitrile rubber	NBR	-20°C to +80°C	Standard material	
	Fluoro rubber	FKM	-20°C to +180°C	Available on request	

\*1: The operable temperature range depends on the operating conditions.

### Maximum Tightening Torque

Nm {kgf·cm}

<b>Size (Thread)</b>	<b>1/4"</b>	<b>3/8"</b>	<b>1/2"</b>
<b>Torque</b>	9 {92}	11 {112}	20 {204}

### Flow Direction

Fluid flow can be bi-directional when socket and plug are connected.



### Interchangeability

K3 series sockets and plugs can be connected regardless of end configuration and sizes. K4 series sockets and plugs can be connected regardless of end configuration and sizes. K3 series and K4 series are not interchangeable with each other. Also not interchangeable with other K-0 series.

### Minimum Cross-Sectional Area

(mm<sup>2</sup>)

Plug \ Socket	K3-03SH	K3-04SH	K3-03SM	K3-03SF	K4-04SH
K3-03PH	38	38	38	38	-
K3-02PM	38	62.5	62.5	62.5	-
K3-03PM	38	62.5	62.5	62.5	-
K3-03PF	38	62.5	62.5	62.5	-
K4-04PM	-	-	-	-	78.5

### Suitability for Vacuum

Not suitable for vacuum application in either connected or disconnected condition.

### Plug Embedment Dimensions

(mm)

Model	D*	C*	L	Remarks
K3-02PM	24 or more	0 to 3	31	* Socket interference prevents connection/disconnection when C exceeds 3 mm.
K3-03PM	24 or more	0 to 3	31	* Size D should be bigger than the outer diameter of the socket wrench to be used.
K4-04PM	32 or more	0 to 3	39	(See JISB4636-1, JISB4636-2)

### Flow Rate – Pressure Loss Characteristics (Comparison with MOLD CUPLA)

[Test conditions] - Fluid : Water - Temperature : 23°C±5°C

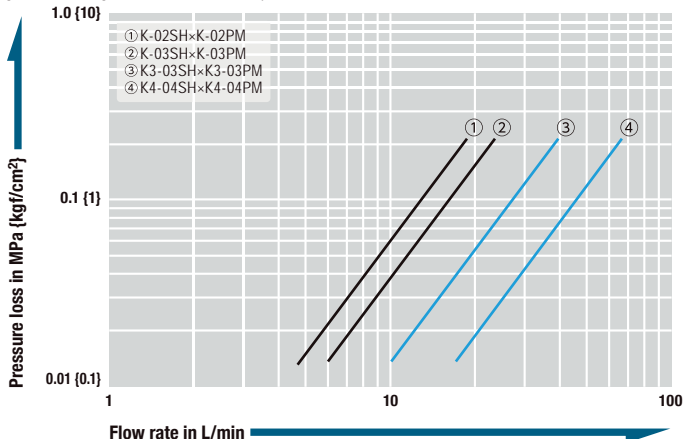

Models and Dimensions

**Plug PH type (Hose barb / High flow type)**

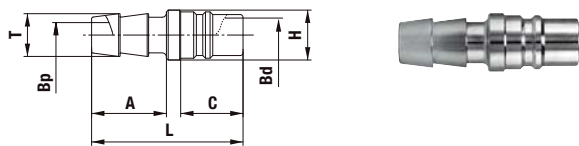

Model	Application (Hose)	Mass (g)	Dimensions (mm)						
			L	A	C	øH	øT	øBp	øBd
K3-03PH	3/8"	19	42.5	21	17.5	14	12	7	9.5

**Socket SH type (Hose barb / High flow type)**

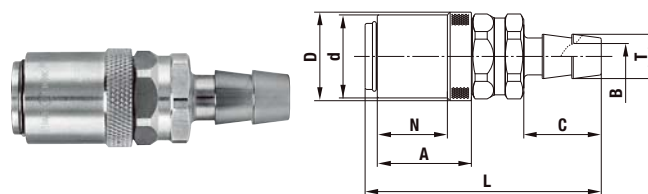

Model	Application (Hose)	Mass (g)	Dimensions (mm)							
			L	øD	ød	N	A	C	øT	øB
K3-03SH	3/8"	100	(65)	(24)	22.5	19	25.5	21	12	7
K3-04SH	1/2"	102	(67)	(24)	22.5	19	25.5	23	15	10
K4-04SH	1/2"	226	(82)	(32)	30	26.5	34	23	15	10

**Plug PM type (Male thread / High flow type)**

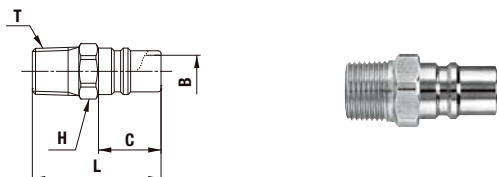

Model	Application (Thread)	Mass (g)	Dimensions (mm)				
			L	C	H(WAF)	øT	øB
K3-02PM	Rc 1/4	16	36	17.5	Hex.14	R 1/4	9
K3-03PM	Rc 3/8	25	36	17.5	Hex.17	R 3/8	9.5
K4-04PM	Rc 1/2	50	46	21.5	Hex.22	R 1/2	13

**Socket SM type (Male thread / High flow type)**

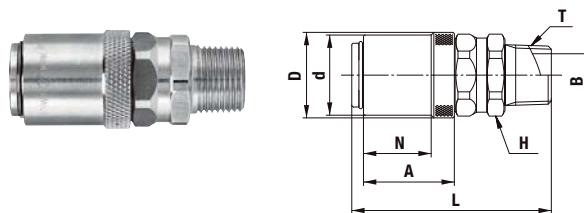

Model	Application (Thread)	Mass (g)	Dimensions (mm)							
			L	øD	ød	N	A	H(WAF)	T	øB
K3-03SM	Rc 3/8	90	(56)	(24)	22.5	19	25.5	Hex.21	R 3/8	12

**Plug PF type (Female thread / High flow type)**

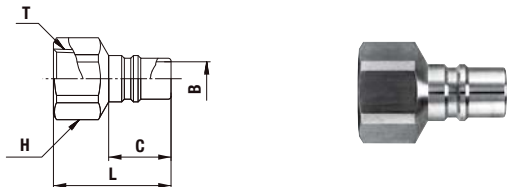

Model	Application (Thread)	Mass (g)	Dimensions (mm)				
			L	H(WAF)	C	T	øB
K3-03PF	R 3/8	30	33	Hex.21	17.5	Rc 3/8	9.5

**Socket SF type (Female thread / High flow type)**

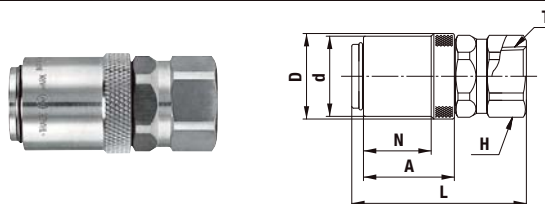

Model	Application (Thread)	Mass (g)	Dimensions (mm)						
			L	øD	ød	N	A	T	H(WAF)
K3-03SF	R 3/8	87	(49)	(24)	22.5	19	25.5	Rc 3/8	Hex.21

Notes: Also available without socket valve (Made-to-order item), identified by product code TS (e.g. K3-03SH without valve is K3-03TSH). Also available are CUPLA with sleeve stopper (Made-to-order item).

Accessory

For low pressure  
For checking the water flow of mold cooling water pipes

**FLOW MONITOR**

Replaceable Flow Vane type

The flow of cooling water can be checked at a glance.

- Fluid flow from low flow rate (2 L/min) water pipes can be visually checked with the rotating two-colored impeller.
- Flow Vane ASSY can be replaced without removing it from the piping.
- The stopper prevents unintended removal of the plastic parts.
- Installation and replacement is easy since the screw part of the T2 side rotates freely to the left and right.

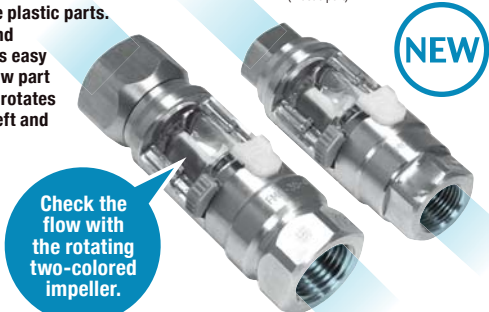

See page 167 for the details.

Flow meter with valve dedicated for mold cooling lines

**FLOW METER**

The coolant flow rate stability and specified flow rate reproducibility have been achieved.

- Graduated scale shows the coolant flow rate numerically, thus reducing operator variation in setting cooling conditions.
- Although small, it has a built-in flow rate adjustment valve, allowing the molding conditions of each machine to be set freely.
- Molding conditions are reproducible and lead time can be shortened.
- Installation and replacement is easy since the screw part of the T2 side rotates freely to the left and right.

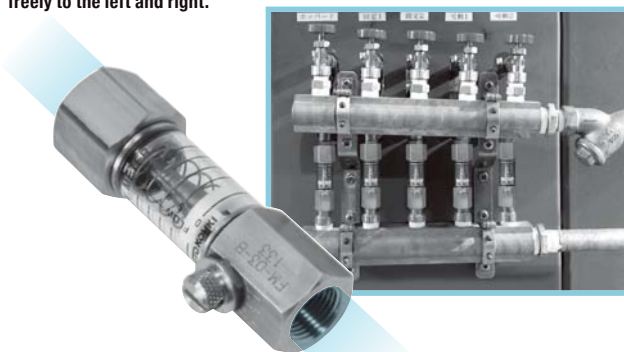

See page 168 for the details.

For Low Pressure

# LEVER LOCK CUPLA Metal Body / Plastic Body

For bulk flow, low pressure applications

**Working pressure**



0.7 to 1.8 MPa  
(7 to 18 kgf/cm<sup>2</sup>)

**Working pressure**



0.2 to 0.5 MPa  
(2 to 5 kgf/cm<sup>2</sup>)





**Valve structure**



Straight through

Designs and specifications are subject to change for improvement without notice

**Applicable fluids (plastic body CUPLA are for water or air only)**

Note: Depending on the temperature of steam / hot water, the heat may damage seal materials.

## Specifications (Metal Body)

<b>Body material (Material symbol)</b>	Aluminum alloy (AL), Copper alloy (BR)				Stainless steel (SUS)			
<b>Size (Thread and hose)</b>	3/4" to 2"	2 1/2"	3"	4"	3/4" to 2"	2 1/2" to 3"	4"	
<b>Working pressure</b>	MPa	1.8	1.1	0.9	0.7	1.8	1.6	1.1
	kgf/cm <sup>2</sup>	18	11	9	7	18	16	11
	bar	18	11	9	7	18	16	11
	PSI	261	160	131	102	261	232	160
<b>Seal material</b>	<b>Seal material</b>				<b>Mark</b>		<b>Working temperature range</b>	
<b>Working temperature range</b>	Nitrile rubber				NBR		-20°C to +80°C	
<b>Optional seal material</b>	<b>Seal material</b>				<b>Mark</b>		<b>Working temperature range</b>	
	Silicone rubber				SI		-40°C to +150°C	
	Fluoro rubber				FKM		-20°C to +180°C	
	Ethylene-propylene rubber				EPDM		-40°C to +150°C	
	FEP-covered silicone rubber <sup>2</sup>				-		+5°C to +50°C	
FEP-covered fluoro rubber <sup>2</sup>				-		+5°C to +50°C		

\*1: The operable temperature range depends on the operating conditions.  
\*2: Made-to-order item (Working pressure : 0.2 MPa (2 kgf/cm<sup>2</sup>))

## Specifications (Plastic Body)

<b>Body material (Material symbol)</b>	Polypropylene (PP)								
<b>Size (Thread and hose)</b>	3/4", 1", 1 1/2"				2", 3"				
<b>Working pressure</b> <sup>*1</sup>	MPa	0.5				0.2			
	kgf/cm <sup>2</sup>	5				2			
	bar	5				2			
	PSI	72.5				29			
<b>Seal material</b>	<b>Seal material</b>				<b>Mark</b>		<b>Working temperature range</b>		
<b>Working temperature range</b>	Nitrile rubber				NBR		+5°C to +50°C		
<b>Optional seal material</b>	<b>Seal material</b>				<b>Mark</b>		<b>Working temperature range</b>		
	Silicone rubber				SI		+5°C to +50°C		
	Fluoro rubber				FKM		+5°C to +50°C		
	Ethylene-propylene rubber				EPDM		+5°C to +50°C		

\*1: Pressure at 20°C. Pressure reduces as temperature rises.  
\*2: The operable temperature range depends on the operating conditions.

## Maximum Tightening Torque

Size (Thread)		Nm {kgf·cm}							
Torque	Aluminum alloy	3/4"	1"	1 1/4"	1 1/2"	2"	2 1/2"	3"	4"
	Copper alloy	50 {510}	70 {714}	120 {1224}	140 {1428}	260 {2652}	350 {3570}	410 {4182}	470 {4794}
	Stainless steel	90 {918}	120 {1224}	220 {2244}	260 {2652}	350 {3570}	480 {4896}	520 {5304}	590 {6018}

## Flow Direction

Fluid flow can be bi-directional when socket and plug are connected.



## Interchangeability

Sockets and plugs can be connected regardless of end configurations if the size is same. Can be connected with products whose mating part dimensions are in compliance with MIL-A-A-59326.

## Suitability for Vacuum (Metal Body) 53.0 kPa (400 mmHg)

Socket only	Plug only	When connected
-	-	Operational

## Suitability for Vacuum (Plastic Body)

Not suitable for vacuum application in either connected or disconnected condition.

## Light lever pull-down will connect the plug and socket without fail ready to flow liquid or gases.

- This CUPLA complies with diversified applications in liquid or gas transportation.
- End-face seal structure enables no bumps or hollows on the internal fluid passage, and ensures smooth fluid transportation.
- A special lip packing (except sizes 3/4" and 1", silicone rubber, and FEP-covered rubber) employed reduces the load to the lever for easy operation.
- Connection part dimensions comply with US military specifications MIL-A-A-59326 (MIL-C-27487).
- The variety of body materials, sizes and end configurations has been standardized to comply with wide range of applications.
- Additional stopper function design will enhance safety (only for made-to-order metal body product).

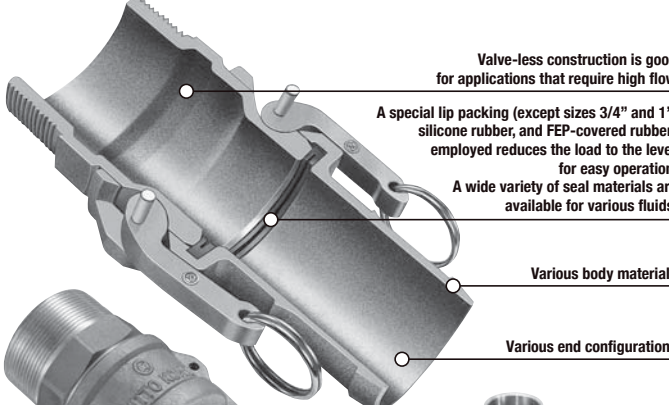

Valve-less construction is good for applications that require high flow

A special lip packing (except sizes 3/4" and 1", silicone rubber, and FEP-covered rubber) employed reduces the load to the lever for easy operation.

A wide variety of seal materials are available for various fluids.

Various body materials

Various end configurations



Metal body (Aluminum alloy, Copper alloy, and Stainless steel) Plastic body

## Dimensions with Lever Fully Opened

Size	Dimensions E (mm)		
	Body material		
3/4"	AL (122.5)	BR (122.5)	SUS (111)
1"	(132)	(132)	(125)
1 1/4"	(183)	(183)	(179)
1 1/2"	(191)	(191)	(187)
2"	(201)	(201)	(196)
2 1/2"	(213)	(209)	(209)
3"	(249)	(249)	(251)
4"	(280)	(278)	(277)

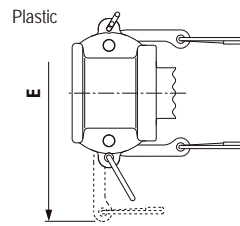

Size	Dimensions E (mm)
3/4"	(115)
1"	(126)
1 1/2"	(187)
2"	(195)
3"	(249)

Models and Dimensions

Plug LE type (Hose barb)

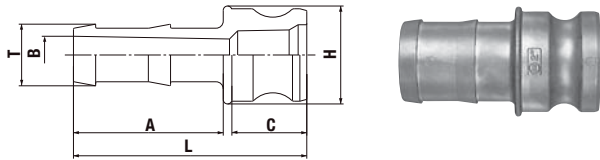

Material	Model	Application (Hose)	Mass (g)	Dimensions (mm)						
				L	A	C	øH	øT	øB	
Aluminum alloy	LE-6TPH	3/4"	65	81	52	26	34	21.4	11	
	LE-8TPH	1"	100	95	58	34	40	27.4	17.5	
	LE-10TPH	1 1/4"	140	102	58	40	48	34.1	23.5	
	LE-12TPH	1 1/2"	190	107	61	42	58	40.5	29	
	LE-16TPH	2"	290	122	70	48	69	53.2	40	
	LE-20TPH	2 1/2"	390	134.5	80	50	81	66.7	50	
	LE-24TPH	3"	545	167	101	49.4	97	79	68	
	LE-32TPH	4"	850	176	106	51.8	133	105	93	
	LE-6TPH	3/4"	215	90.5	52.5	26	39	21.5	12.5	
Copper alloy	LE-8TPH	1"	305	107	60	34.5	41	27.5	20	
	LE-10TPH	1 1/4"	507	119	66	42	47	34.4	26.7	
	LE-12TPH	1 1/2"	600	114	61	42	60	41.2	33	
	LE-16TPH	2"	865	131	73	44	70.5	53.5	44.5	
	LE-20TPH	2 1/2"	1180	149	84	48	91	67	57	
	LE-24TPH	3"	1800	171	104	50	102	79	70	
	LE-32TPH	4"	3500	176	109	52	129	105	93	
	LE-6TPH	3/4"	170	90	52	27	35	21	15	
	LE-8TPH	1"	265	107	60	35	42	27	20	
Stainless steel	LE-10TPH	1 1/4"	430	111	61	40	48	34	25.5	
	LE-12TPH	1 1/2"	530	114	61	40	60	40	33	
	LE-16TPH	2"	790	131	73	45	70	53	44	
	LE-20TPH	2 1/2"	1195	137	80.5	42.7	83	67	56	
	LE-24TPH	3"	1755	162	99.5	49.2	102	78	68	
	LE-32TPH	4"	2595	174	109	50	130	105	94	

Socket LC type (Hose barb)

Model LC-6TSH made of aluminum alloy and copper alloy has no rings.

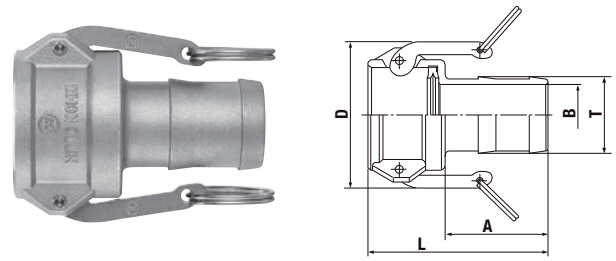

Material	Model	Application (Hose)	Mass (g)	Dimensions (mm)				
				L	A	D	øT	øB
Aluminum alloy	LC-6TSH	3/4"	140	85	52	(60.5)	21.4	(11)
	LC-8TSH	1"	190	99	58	(61)	27.4	(17)
	LC-10TSH	1 1/4"	320	104	58	(82)	34.1	(23)
	LC-12TSH	1 1/2"	350	108.5	61	(90)	40.5	(29)
	LC-16TSH	2"	430	122.5	70	(100)	53.2	(41.5)
	LC-20TSH	2 1/2"	560	136.5	80	(112)	66.7	(54)
	LC-24TSH	3"	915	175	100	(139)	79	68
	LC-32TSH	4"	1190	180	104	(165)	104	93
	LC-6TSH	3/4"	276	86	53	(53)	21.8	13
Copper alloy	LC-8TSH	1"	410	101	60	(62)	27.4	20
	LC-10TSH	1 1/4"	700	104	58	(82)	34.1	25.5
	LC-12TSH	1 1/2"	720	110	62	(91)	41	33
	LC-16TSH	2"	870	121	70	(100)	53	44
	LC-20TSH	2 1/2"	1530	137	83	(113)	67	57
	LC-24TSH	3"	1795	160	105	(139)	79	68
	LC-32TSH	4"	3100	163	107	(168)	104	92
	LC-6TSH	3/4"	230	86	52	(55)	21	15
	LC-8TSH	1"	340	99	60	(63)	27	20
Stainless steel	LC-10TSH	1 1/4"	615	107	61	(85)	34	25.5
	LC-12TSH	1 1/2"	645	108	61	(91)	40	33
	LC-16TSH	2"	1000	129	73	(101)	53	44
	LC-20TSH	2 1/2"	1270	134	81	(113)	67	57
	LC-24TSH	3"	2065	158	100	(139)	79	67
	LC-32TSH	4"	3020	165	107	(167)	105	94

Plug LA type (Female thread)

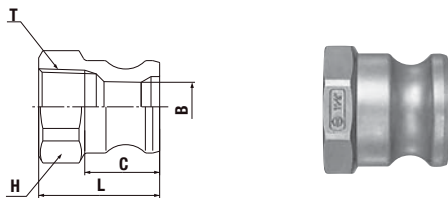

Material	Model	Application (Thread)	Mass (g)	Dimensions (mm)				
				L	C	H(WAF)	øB	T
Aluminum alloy	LA-6TPF	3/4"	45	42	26	Hex.36	17	Rc 3/4
	LA-8TPF	1"	65	52	34	Hex.41	22.5	Rc 1
	LA-10TPF	1 1/4"	110	59	40	Hex.50	27.5	Rc 1 1/4
	LA-12TPF	1 1/2"	130	58	42	Oct.60	34.5	Rc 1 1/2
	LA-16TPF	2"	170	63.5	48	Oct.70	44.5	Rc 2
	LA-20TPF	2 1/2"	320	85	50	Oct.85	55.5	Rc 2 1/2
	LA-24TPF	3"	370	79	52.5	Dod.99	73.5	Rc 3
	LA-32TPF	4"	640	82	54	Dod.130	100	Rc 4
	LA-6TPF	3/4"	145	42	27	Oct.34	20	Rc 3/4
Copper alloy	LA-8TPF	1"	190	46	32	Oct.41	24	Rc 1
	LA-10TPF	1 1/4"	390	59	40	Hex.50	28	Rc 1 1/4
	LA-12TPF	1 1/2"	420	58	42	Oct.60	36	Rc 1 1/2
	LA-16TPF	2"	560	63.5	48	Oct.70	45	Rc 2
	LA-20TPF	2 1/2"	950	79	50	Dod.84	56	Rc 2 1/2
	LA-24TPF	3"	1210	71	50	Dod.101	70	Rc 3
	LA-32TPF	4"	1620	79	53	Dod.127	101	Rc 4
	LA-6TPF	3/4"	120	39	27	Oct.33	19	Rc 3/4
	LA-8TPF	1"	170	47	33	Oct.41	24	Rc 1
Stainless steel	LA-10TPF	1 1/4"	270	53.5	41	Oct.50	28	Rc 1 1/4
	LA-12TPF	1 1/2"	375	55	40	Oct.58	35.5	Rc 1 1/2
	LA-16TPF	2"	505	62	47	Oct.69	45	Rc 2
	LA-20TPF	2 1/2"	825	77	49	Dod.83	56	Rc 2 1/2
	LA-24TPF	3"	875	72	51	Dod.96	73	Rc 3
	LA-32TPF	4"	1470	79	53	Dod.124	100	Rc 4

Socket LD type (Female thread)

Model LD-6TSF made of aluminum alloy and copper alloy has no rings.

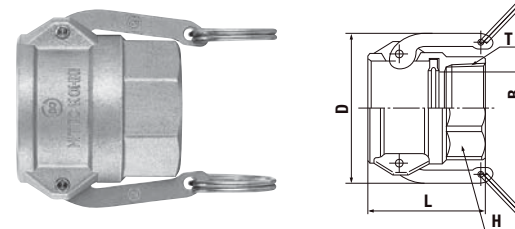

Material	Model	Application (Thread)	Mass (g)	Dimensions (mm)				
				L	D	H(WAF)	øB	T
Aluminum alloy	LD-6TSF	3/4"	130	53	(62.4)	Hex.36	21	Rc 3/4
	LD-8TSF	1"	190	64.5	(61)	Hex.41	26	Rc 1
	LD-10TSF	1 1/4"	330	72.5	(82)	Hex.50	34	Rc 1 1/4
	LD-12TSF	1 1/2"	360	70.5	(90)	Oct.60	39	Rc 1 1/2
	LD-16TSF	2"	420	79.5	(100)	Oct.70	49	Rc 2
	LD-20TSF	2 1/2"	550	88.5	(112)	Oct.85	59	Rc 2 1/2
	LD-24TSF	3"	800	89	(140)	Dod.99	75	Rc 3
	LD-32TSF	4"	1140	93	(165)	Dod.131	94	Rc 4
	LD-6TSF	3/4"	310	53	(60.5)	Hex.36	21	Rc 3/4
Copper alloy	LD-8TSF	1"	430	64.5	(61)	Hex.41	26	Rc 1
	LD-10TSF	1 1/4"	730	72.5	(82)	Hex.50	34	Rc 1 1/4
	LD-12TSF	1 1/2"	770	70.5	(90)	Oct.60	39	Rc 1 1/2
	LD-16TSF	2"	990	79.5	(100)	Oct.70	49	Rc 2
	LD-20TSF	2 1/2"	1290	81.5	(113)	Dod.84	61	Rc 2 1/2
	LD-24TSF	3"	1560	87	(139)	Oct.96	77	Rc 3
	LD-32TSF	4"	3590	91	(165)	Oct.126	96	Rc 4
	LD-6TSF	3/4"	225	52	(55)	Oct.32	19	Rc 3/4
	LD-8TSF	1"	350	60	(63)	Oct.41	24	Rc 1
Stainless steel	LD-10TSF	1 1/4"	600	68	(85)	Oct.50	30	Rc 1 1/4
	LD-12TSF	1 1/2"	715	72	(87)	Oct.58	37.5	Rc 1 1/2
	LD-16TSF	2"	940	78.5	(100)	Oct.69	50	Rc 2
	LD-20TSF	2 1/2"	1050	82	(113)	Dod.83	61	Rc 2 1/2
	LD-24TSF	3"	1605	84	(140)	Dod.97	77	Rc 3
	LD-32TSF	4"	2575	94	(167)	Dod.125	97	Rc 4



Models and Dimensions

Plug LF type (Male thread)

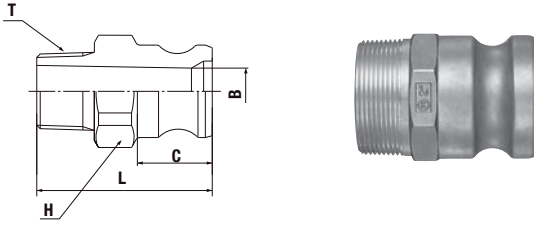

Material	Model	Application (Thread)	Mass (g)	Dimensions (mm)				
				L	C	H(WAF)	øB	T
Aluminum alloy	LF-6TPM	3/4"	70	61	26	Hex.36	16	R 3/4
	LF-8TPM	1"	90	73	34	Hex.41	22	R 1
	LF-10TPM	1 1/4"	140	81	40	Hex.50	28	R 1 1/4
	LF-12TPM	1 1/2"	150	80.5	42	Oct.55	34.5	R 1 1/2
	LF-16TPM	2"	220	89.5	48	Oct.65	44.5	R 2
	LF-20TPM	2 1/2"	370	101	50	Oct.80	56	R 2 1/2
	LF-24TPM	3"	470	106	52	Dod.99	73	R 3
	LF-32TPM	4"	875	116	54	Dod.130	100	R 4
	Copper alloy	LF-6TPM	3/4"	185	59	27	Oct.34	20
LF-8TPM		1"	280	69	32	Oct.41	24	R 1
LF-10TPM		1 1/4"	460	81	40	Hex.50	28	R 1 1/4
LF-12TPM		1 1/2"	500	80.5	42	Oct.55	36	R 1 1/2
LF-16TPM		2"	750	89.5	48	Oct.65	45	R 2
LF-20TPM		2 1/2"	1290	98	50	Dod.83	56	R 2 1/2
LF-24TPM		3"	1480	103	50.8	Dod.96	73	R 3
LF-32TPM		4"	3155	113	53	Dod.126	100	R 4
Stainless steel		LF-6TPM	3/4"	175	59	27	Oct.33	19
	LF-8TPM	1"	255	69	33	Oct.41	24	R 1
	LF-10TPM	1 1/4"	415	80	42	Oct.50	29.5	R 1 1/4
	LF-12TPM	1 1/2"	575	80	40	Oct.58	36.5	R 1 1/2
	LF-16TPM	2"	680	90	46.5	Oct.69	46	R 2
	LF-20TPM	2 1/2"	1020	99	49	Dod.83	56	R 2 1/2
	LF-24TPM	3"	1415	103	51	Dod.96	73	R 3
	LF-32TPM	4"	2275	112	53	Dod.124	100	R 4

Socket LB type (Male thread)

Model LB-6TSM made of aluminum alloy has no rings.

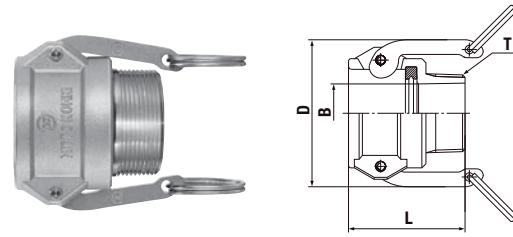

Material	Model	Application (Thread)	Mass (g)	Dimensions (mm)				
				L	D	øB	T	
Aluminum alloy	LB-6TSM	3/4"	110	53	(60.5)	(17)	R 3/4	
	LB-8TSM	1"	170	65	(61)	(235)	R 1	
	LB-10TSM	1 1/4"	310	72	(82)	29.5	R 1 1/4	
	LB-12TSM	1 1/2"	340	71.5	(90)	36	R 1 1/2	
	LB-16TSM	2"	400	79.5	(100)	(46)	R 2	
	LB-20TSM	2 1/2"	530	88.5	(112)	(57.5)	R 2 1/2	
	LB-24TSM	3"	715	90	(139)	76	R 3	
	LB-32TSM	4"	920	92	(165)	99	R 4	
	Copper alloy (Made-to-order item)	LB-6TSM	3/4"	260	52	(53)	19.5	R 3/4
		LB-8TSM	1"	355	63	(62)	26	R 1
		LB-10TSM	1 1/4"	620	71	(84)	28	R 1 1/4
		LB-12TSM	1 1/2"	700	71	(91)	36	R 1 1/2
LB-16TSM		2"	950	81	(100)	51	R 2	
LB-20TSM		2 1/2"	1250	86	(113)	63	R 2 1/2	
Stainless steel (Available on request)	LB-24TSM	3"	1780	92	(139)	78	R 3	
	LB-32TSM	4"	2540	98	(168)	101	R 4	
	LB-6TSM	3/4"	210	52.5	(55)	20	R 3/4	
	LB-8TSM	1"	300	63	(63)	25.5	R 1	
	LB-10TSM	1 1/4"	520	70.5	(85)	34	R 1 1/4	
	LB-12TSM	1 1/2"	580	71.5	(87)	38	R 1 1/2	
	LB-16TSM	2"	780	78.5	(101)	50.5	R 2	
	LB-20TSM	2 1/2"	980	84	(113)	66	R 2 1/2	
LB-24TSM	3"	1490	92	(139)	78.5	R 3		
LB-32TSM	4"	2080	92	(167)	103.5	R 4		

Plug L-PD type (Plug cap)

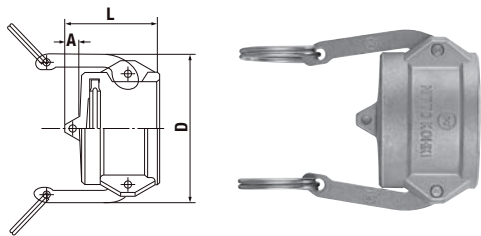

Material	Model	Size	Mass (g)	Dimensions (mm)		
				L	A	D
Aluminum alloy	L-6PD	3/4"	100	46	12	(54)
	L-8PD	1"	145	54	11.5	(62)
	L-10PD	1 1/4"	230	60	13	(83)
	L-12PD	1 1/2"	295	68	17	(91)
	L-16PD	2"	360	68	11	(100)
	L-20PD	2 1/2"	435	72	15	(113)
	L-24PD	3"	690	72	10	(139)
	L-32PD	4"	870	76	15	(167)
	Copper alloy	L-6PD	3/4"	220	45	11
L-8PD		1"	315	53	12	(62)
L-10PD		1 1/4"	610	61	13	(84)
L-12PD		1 1/2"	645	69	17.5	(91)
L-16PD		2"	830	68	11	(100)
L-20PD		2 1/2"	980	71	14	(113)
L-24PD		3"	1380	81	20	(139)
L-32PD		4"	2700	90	26	(168)
Stainless steel		L-6PD	3/4"	180	45	12
	L-8PD	1"	265	52	11	(63)
	L-10PD	1 1/4"	475	60	11	(85)
	L-12PD	1 1/2"	545	63	15	(87)
	L-16PD	2"	720	65	11	(101)
	L-20PD	2 1/2"	945	71	15	(113)
	L-24PD	3"	1420	72	12	(139)
	L-32PD	4"	2055	77	14	(167)

Socket L-SD type (Socket cap)

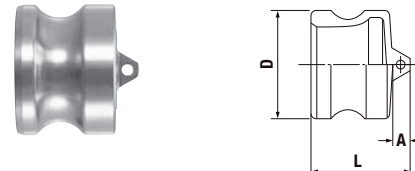

Material	Model	Size	Mass (g)	Dimensions (mm)			
				L	A	øD	
Aluminum alloy	L-6SD	3/4"	35	32	8	32	
	L-8SD	1"	45	44	10	36.7	
	L-10SD	1 1/4"	70	57	14	45.5	
	L-12SD	1 1/2"	90	54	15	53.4	
	L-16SD	2"	140	62	13	63	
	L-20SD	2 1/2"	210	69	20	75.8	
	L-24SD	3"	290	71	15	91.5	
	L-32SD	4"	960	74	16	119.4	
	Copper alloy	L-6SD	3/4"	160	34	8	32.1
		L-8SD	1"	150	44	10	36.7
		L-10SD	1 1/4"	210	55	12	45.5
		L-12SD	1 1/2"	290	54	15	53.4
L-16SD		2"	420	61	12	63	
L-20SD		2 1/2"	630	69	19	75.7	
Stainless steel	L-24SD	3"	860	71	15	91.5	
	L-32SD	4"	1780	74.5	16	119.4	
	L-6SD	3/4"	95	39	12	32	
	L-8SD	1"	145	45	12	37	
	L-10SD	1 1/4"	250	51	10	45	
	L-12SD	1 1/2"	300	54	14	53	
	L-16SD	2"	490	59.5	12.5	63	
	L-20SD	2 1/2"	710	64	14	76	
L-24SD	3"	930	68	14	92		
L-32SD	4"	1275	68	14	120		



Models and Dimensions

Designs and specifications are subject to change for improvement without notice. / WAF : WAF stands for width across flats.

**Plug** LE type (Hose barb)

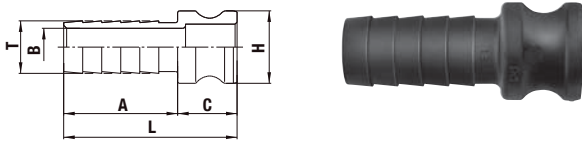

Material	Model	Application (Hose)	Mass (g)	Dimensions (mm)					
				L	A	C	øH	øT	øB
Plastic	LE-6TPH	3/4"	16	74.5	51.5	(23)	(32)	20.7	14.2
	LE-8TPH	1"	29	87.5	57.5	(30)	(36.5)	26.3	19
	LE-12TPH	1 1/2"	73	103	61.5	(41.5)	(53.5)	40	30
	LE-16TPH	2"	122	119	71	(48)	(63)	52.5	41
	LE-24TPH	3"	221	151.5	106.5	(45)	(91.5)	77	64.5

**Socket** LC type (Hose barb)

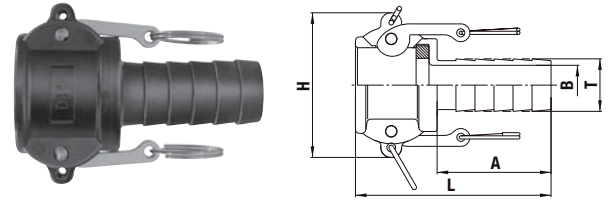

Material	Model	Application (Hose)	Mass (g)	Dimensions (mm)					
				L	A	H	øT	øB	
Plastic	LC-6TSH	3/4"	64	83	52	(63.5)	20.2	14	
	LC-8TSH	1"	104	97.5	56.5	(73)	26.2	20	
	LC-12TSH	1 1/2"	242	109.5	58	(95)	39	29.5	
	LC-16TSH	2"	269	125	70.5	(105.5)	52.5	41	
	LC-24TSH	3"	527	161	102	(136.5)	77	64.5	

**Plug** LA type (Female thread)

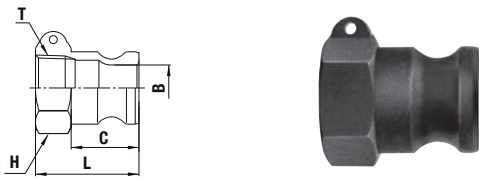

Material	Model	Application (Thread)	Mass (g)	Dimensions (mm)				
				L	C	H(WAF)	øB	T
Plastic	LA-6TPF	3/4"	19	42	(26)	Hex.34	21.3	Rc 3/4
	LA-8TPF	1"	27	59	(34)	Hex.43	22	Rc 1
	LA-12TPF	1 1/2"	65	67	(42)	Ribbed 65	34	Rc 1 1/2
	LA-16TPF	2"	102	73	(47.5)	Ribbed 78	42	Rc 2
	LA-24TPF	3"	211	90	(52.5)	Ribbed 108	71	Rc 3

**Socket** LD type (Female thread)

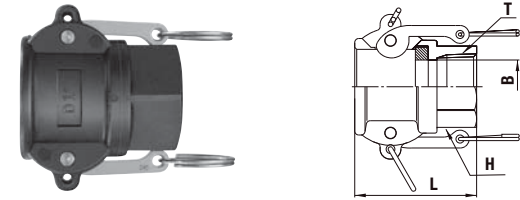

Material	Model	Application (Thread)	Mass (g)	Dimensions (mm)			
				L	H(WAF)	øB	T
Plastic	LD-6TSF	3/4"	65	49	Hex.32	21.5	Rc 3/4
	LD-8TSF	1"	98	61	Hex.41	27	Rc 1
	LD-12TSF	1 1/2"	260	77.5	Ribbed 68	39	Rc 1 1/2
	LD-16TSF	2"	285	83	Ribbed 80	51	Rc 2
	LD-24TSF	3"	444	90.5	Ribbed 109	77.5	Rc 3

**Plug** LF type (Male thread)

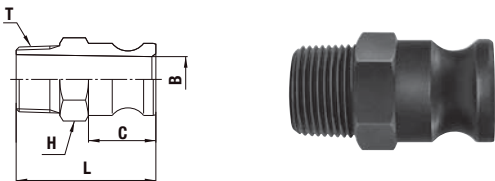

Material	Model	Application (Thread)	Mass (g)	Dimensions (mm)				
				L	C	H(WAF)	øB	T
Plastic	LF-6TPM	3/4"	23	60	(26)	Hex.32	19	R 3/4
	LF-8TPM	1"	19	71	(34)	Hex.37	23	R 1
	LF-12TPM	1 1/2"	72	77	(42)	Ribbed 63	32	R 1 1/2
	LF-16TPM	2"	105	84.5	(48)	Ribbed 74	44.5	R 2
	LF-24TPM	3"	210	102.5	(51.5)	Ribbed 100	72	R 3

**Socket** LB type (Male thread)

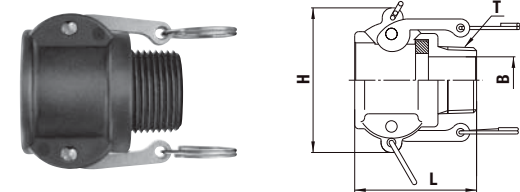

Material	Model	Application (Thread)	Mass (g)	Dimensions (mm)			
				L	H	øB	T
Plastic	LB-6TSM	3/4"	58	49.5	(63.5)	19	R 3/4
	LB-8TSM	1"	88	61	(73)	23.5	R 1
	LB-12TSM	1 1/2"	227	77.5	(95)	37	R 1 1/2
	LB-16TSM	2"	251	82.5	(105.5)	48	R 2
	LB-24TSM	3"	397	88	(136.5)	75	R 3

**Plug** L-PD type (Plug cap)

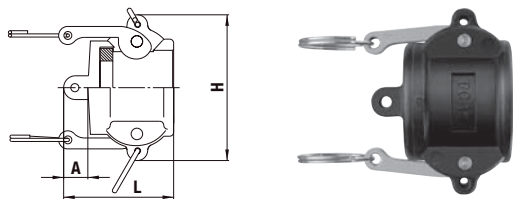

Material	Model	Size	Mass (g)	Dimensions (mm)		
				L	A	H
Plastic	L-6PD	3/4"	60	45	12	(63.5)
	L-8PD	1"	94	55.5	12	(73)
	L-12PD	1 1/2"	214	65	15	(95)
	L-16PD	2"	219	70.5	16	(106)
	L-24PD	3"	408	77	17.5	(136)

**Socket** L-SD type (Socket cap)



Material	Model	Size	Mass (g)	Dimensions (mm)		
				L	A	øD
Plastic	L-6SD	3/4"	10	35.5	12	(32.1)
	L-8SD	1"	18	42.5	11	(36.5)
	L-12SD	1 1/2"	46	53.5	14	(53.2)
	L-16SD	2"	68	63	16	(63)
	L-24SD	3"	102	71	17.5	(109)

For Medium Pressure

# TSP CUPLA

For medium pressure general applications

Working pressure



1.5 to 7.5 MPa  
(15 to 76 kgf/cm<sup>2</sup>)

Valve structure



Straight through

Applicable fluids for braided hose connection type depend upon the specifications of braided hoses to be used.

Applicable fluids



Note: Depending on the temperature of steam / hot water, the heat may damage seal materials.

Valveless structure suits high viscosity fluids! Various body materials, sizes and end configurations.

Braided hose connection types are newly added.

- Valveless construction drastically saves pressure loss and achieves high flow rate.
- Suitable for high viscosity fluids (such as grease).
- Available in various standard body materials, sizes and end configurations to cope with diversified applications and operating situations.
- No hose clamp required! Simple and secure connection to braided hose.

Note: See the pages of Seal Material Selection Table at the end of this catalog for the suitability of seal materials to fluids.

For connection to braided hoses

Benefits without a hose clamp

Two piece design

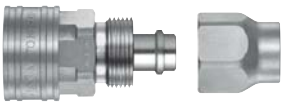

Please use braided hoses available in the market.



## Specifications

Body material	Brass				Stainless steel (SUS304), Steel (Nickel plated)						
Size (Thread and hose)	1/8", 1/4" 3/8", 1/2"	3/4" 1"	1 1/4" 1 1/2"	2"	1/8", 1/4" 3/8", 1/2"	3/4" 1"	1 1/4" 1 1/2"	2"			
Working pressure	MPa	5.0	3.0	2.0	1.5	7.5	4.5	3.0	2.0		
	kgf/cm <sup>2</sup>	51	31	20	15	76	46	31	20		
	bar	50	30	20	15	75	45	30	20		
	PSI	725	435	290	218	1090	653	435	290		
Seal material <sup>1</sup>	Seal material	Nitrile rubber		FKM		Ethylene-propylene rubber		Mark	NBR	FKM	EPDM
	Working temperature range <sup>2</sup>	-20°C to +80°C		-20°C to +180°C		-40°C to +150°C		Working temperature range	-20°C to +80°C		
	Standard material										

- SUS316 is available as option.

- Maximum working pressure and working temperature range of TSP CUPLA for braided hoses depend upon the specifications of braided hoses to be used.

<sup>1</sup>: Seal material available for braided hoses is nitrile rubber only.

<sup>1</sup>: Seal material available for steel body is nitrile rubber only.

<sup>2</sup>: The operable temperature range depends on the operating conditions.

## Maximum Tightening Torque

Nm {kgf·cm}

Size (Thread)	1/8"	1/4"	3/8"	1/2"	3/4"	1"	1 1/4"	1 1/2"	2"	
Torque	Steel	9 {92}	14 {143}	22 {224}	60 {612}	90 {918}	120 {1224}	260 {2652}	280 {2856}	500 {5100}
	Brass	5 {51}	9 {92}	12 {122}	30 {306}	50 {510}	65 {663}	150 {1530}	160 {1632}	260 {2652}
	Stainless steel	9 {92}	14 {143}	22 {224}	60 {612}	90 {918}	120 {1224}	260 {2652}	280 {2856}	500 {5100}

\* Tighten the nut for braided hoses until it is flush against the hose barb base.

## Flow Direction

Fluid flow can be bi-directional when socket and plug are connected.



## Interchangeability

Sockets and plugs can be connected regardless of end configurations if the first number(s) of the model is the same.

## Minimum Cross-Sectional Area

(mm<sup>2</sup>)

Model	1TSP	2TSP	3TSP	4TSP	6TSP	8TSP	10TSP	12TSP	16TSP
End configurations									
H type (Hose barb)	7.0 (ø3)	19.6 (ø5)	38.4 (ø7)	78.5 (ø10)	176 (ø15)	283 (ø19)	530 (ø26)	804 (ø32)	1256 (ø40)
M type / F type (Male thread / Female thread)	15.9 (ø4.5)	33.1 (ø6.5)	78.5 (ø10)	132 (ø13)	226 (ø17)	452 (ø24)	804 (ø32)	1134 (ø38)	1885 (ø49)
Model	2TSN-60	3TSN-90	4TSN-120	4TSN-150	6TSN-190	8TSN-250			
End configurations									
N type (For braided hose connection)	23.7 (ø5.5)	56.7 (ø8.5)	95.0 (ø11)	132 (ø13)	226 (ø17)	415 (ø23)			

## Suitability for Vacuum

1.3×10<sup>-1</sup> Pa {1×10<sup>-3</sup> mmHg}

Socket only	Plug only	When connected
-	-	Operational

## Flow Rate – Pressure Loss Characteristics

[Test conditions] - Fluid : Hydraulic oil - Temperature : 30°C±10°C  
- Fluid viscosity : 32×10<sup>-6</sup> m<sup>2</sup>/s - Density : 0.87×10<sup>3</sup> kg/m<sup>3</sup>

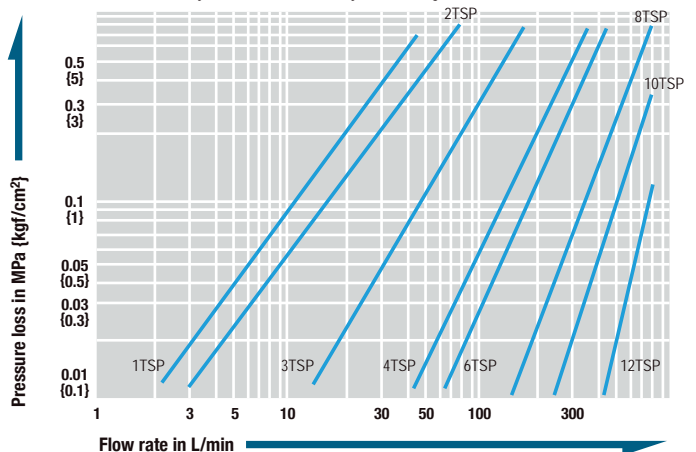

Models and Dimensions

**Plug TPH type (Hose barb)**

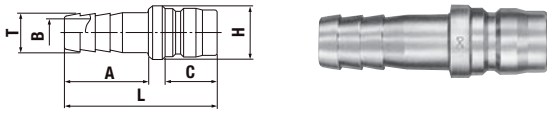

Model	Application (Hose)	Mass (g)			Dimensions (mm)					
		Steel	Brass	Stainless steel	L	ØH	A	C	ØT	ØB
1TPH	1/8"	12 <sup>*1</sup>	13	12	41	12	20	15.5	6.5	3
2TPH	1/4"	21	23	21	53	14	29	18	8	5
3TPH	3/8"	38	41	38	60	18	32	21	11	7
4TPH	1/2"	71	77	71	70	22	39	24	15	10
6TPH	3/4"	134	146	135	84	28	48	28	21	15
8TPH	1"	327	356	329	105	40	57	36	27	19
10TPH	1 1/4"	495	530	500	121	48	70	39	34.5	26
12TPH	1 1/2"	665	715	660	132	55	75	45	41	32
16TPH	2"	1330	1430	1345	142	70	80	51	54	40

**Plug TPM type (Male thread)**



Model	Application (Thread)	Mass (g)			Dimensions (mm)					
		Steel	Brass	Stainless steel	L	H(WAF)	C	T	ØB	
1TPM	Rc 1/8	16 <sup>*1</sup>	17	17	32	Hex.12	15.5	R 1/8	4.5	
2TPM	Rc 1/4	30	33	30	38	Hex.17	18	R 1/4	6.5	
3TPM	Rc 3/8	38	42	38	43	Hex.17	21	R 3/8	10	
4TPM	Rc 1/2	81	88	81	52	Hex.22	24	R 1/2	13	
6TPM	Rc 3/4	164	179	165	59	Hex.32	28	R 3/4	17	
8TPM	Rc 1	273	297	274	73	Hex.41	36	R 1	25	
10TPM	Rc 1 1/4	520	560	530	83	Hex.50	39	R 1 1/4	32	
12TPM	Rc 1 1/2	655	705	665	93	Hex.54 <sup>*2</sup>	45	R 1 1/2	38	
16TPM	Rc 2	1240	1345	1250	102	75×Ø80	51	R 2	50	

**Plug TPF type (Female thread)**

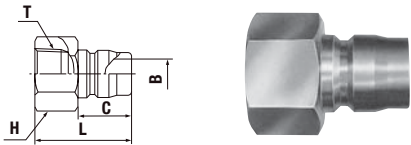

Model	Application (Thread)	Mass (g)			Dimensions (mm)					
		Steel	Brass	Stainless steel	L	H(WAF)	C	T	ØB	
1TPF	R 1/8	14 <sup>*1</sup>	15	14	26	Hex.14	15.5	Rc 1/8	4.5	
2TPF	R 1/4	28	31	29	34	Hex.17	18	Rc 1/4	6.5	
3TPF	R 3/8	43	47	43	38	Hex.21	21	Rc 3/8	10	
4TPF	R 1/2	103	113	104	45	Hex.29	24	Rc 1/2	13	
6TPF	R 3/4	166	181	167	51	Hex.35	28	Rc 3/4	17	
8TPF	R 1	321	350	323	60	Hex.41	36	Rc 1	26	
10TPF	R 1 1/4	567	615	573	64	Hex.54 <sup>*3</sup>	39	Rc 1 1/4	32	
12TPF	R 1 1/2	703	763	630	75	Hex.58 <sup>*4</sup>	45	Rc 1 1/2	38	
16TPF	R 2	1226	1374	1190	83	77×Ø82	51	Rc 2	50	

**Plug TPN type (For braided hose connection)**

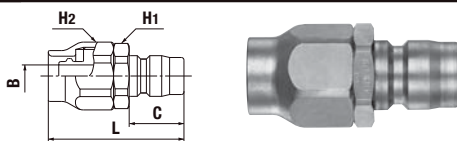

Model	Application (Hose) <sup>*5</sup>		Mass (g)		Dimensions (mm)					
	Size (mm)	Hose wall thickness (mm)	Brass	Stainless steel	L	H1(WAF)	H2(WAF)	C	ØB	
2TPN-60	Ø6×Ø11	2.5±0.25	60	55	(47)	Hex.19	Hex.19	18	5.5	
3TPN-90	Ø9×Ø15	3±0.3	93	87	(52)	Hex.23	Hex.24	21	8.5	
4TPN-120	Ø12×Ø18		140	130	(60)	Hex.27	Hex.27	24	11	
4TPN-150	Ø15×Ø22	3.5±0.35	182	170	(68)	Hex.30	Hex.30	24	13	
6TPN-190	Ø19×Ø26		261	245	(76)	Hex.35	Hex.35	28	17	
8TPN-250	Ø25×Ø33		4±0.4	461	427	(96)	Hex.41	Hex.41	36	23

**Socket TSH type (Hose barb)**

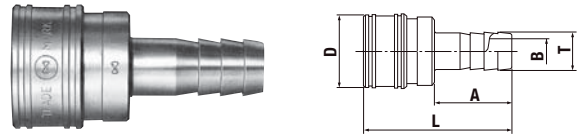

Model	Application (Hose)	Mass (g)			Dimensions (mm)					
		Steel	Brass	Stainless steel	L	ØD	A	ØT	ØB	
1TSH	1/8"	24 <sup>*1</sup>	26	24	40	17.5	20	6.5	3	
2TSH	1/4"	63	69	64	55	24	29	8	5	
3TSH	3/8"	95	104	96	62	28	32	11	7	
4TSH	1/2"	176	192	177	74	35	39	15	10	
6TSH	3/4"	348	379	350	90	45	48	21	15	
8TSH	1"	570	605	570	102	58	57	27	19	
10TSH	1 1/4"	840	910	850	117	69	70	34.5	26	
12TSH	1 1/2"	1060	1140	1070	128	75	75	41	32	
16TSH	2"	2095	2251	2100	141	98	80	54	40	

**Socket TSM type (Male thread)**

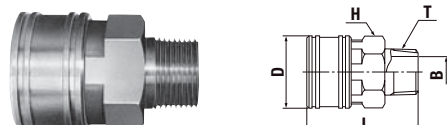

Model	Application (Thread)	Mass (g)			Dimensions (mm)					
		Steel	Brass	Stainless steel	L	ØD	H(WAF)	T	ØB	
1TSM	Rc 1/8	25 <sup>*1</sup>	27	26	30	17.5	Hex.14	R 1/8	4.5	
2TSM	Rc 1/4	66	72	67	42	24	Hex.19	R 1/4	6.5	
3TSM	Rc 3/8	99	108	100	46	28	Hex.23	R 3/8	10	
4TSM	Rc 1/2	178	194	179	56	35	Hex.29	R 1/2	13	
6TSM	Rc 3/4	343	374	346	65	45	Hex.38	R 3/4	18	
8TSM	Rc 1	629	665	633	76	58	Hex.50	R 1	24	
10TSM	Rc 1 1/4	950	1,010	955	86	69	54×Ø64	R 1 1/4	32	
12TSM	Rc 1 1/2	1180	1275	1190	95	75	58×Ø70	R 1 1/2	38	
16TSM	Rc 2	2040	2190	2060	108	98	77×Ø82	R 2	49	

**Socket TSF type (Female thread)**



Model	Application (Thread)	Mass (g)			Dimensions (mm)			
		Steel	Brass	Stainless steel	L	ØD	H(WAF)	T
1TSF	R 1/8	25 <sup>*1</sup>	27	25	27	17.5	Hex.14	Rc 1/8
2TSF	R 1/4	57	62	57	32	24	Hex.19	Rc 1/4
3TSF	R 3/8	83	90	83	35	28	Hex.23	Rc 3/8
4TSF	R 1/2	153	167	154	42	35	Hex.29	Rc 1/2
6TSF	R 3/4	288	314	289	48	45	Hex.38	Rc 3/4
8TSF	R 1	575	607	575	59	58	Hex.50	Rc 1
10TSF	R 1 1/4	821	888	825	64	69	54×Ø62.5	Rc 1 1/4
12TSF	R 1 1/2	1003	1064	1005	71	75	58×Ø70	Rc 1 1/2
16TSF	R 2	1765	1880	1770	80	98	77×Ø82	Rc 2

**Socket TSN type (For braided hose connection)**

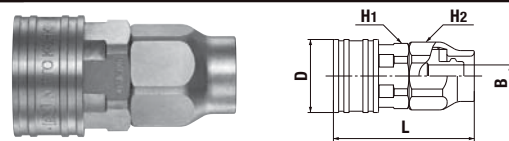

Model	Application (Hose) <sup>*5</sup>		Mass (g)		Dimensions (mm)					
	Size (mm)	Hose wall thickness (mm)	Brass	Stainless steel	L	ØD	H1(WAF)	H2(WAF)	ØB	
2TSN-60	Ø6×Ø11	2.5±0.25	91	84	(49)	24	Hex.19	Hex.19	5.5	
3TSN-90	Ø9×Ø15	3±0.3	139	129	(54)	28	Hex.23	Hex.24	8.5	
4TSN-120	Ø12×Ø18		222	206	(62)	35	Hex.29	Hex.27	11	
4TSN-150	Ø15×Ø22	3.5±0.35	255	237	(70)	35	Hex.30	Hex.30	13	
6TSN-190	Ø19×Ø26		435	408	(81)	45	Hex.38	Hex.35	17	
8TSN-250	Ø25×Ø33		4±0.4	677	633	(93)	58	Hex.50	Hex.41	23

\*1 : 1TSP steel is a made-to-order item. \*2 : Stainless steel: 54×Ø60 \*3 : Stainless steel: 54×Ø59 \*4 : Stainless steel: 58×Ø65 \*5 : Braided hoses for TPN type and TSN type should be made of soft PVC and woven by reinforcement thread. Hydrocarbon type grease is applied to the threaded part of stainless steel nut for TPN type and TSN type to prevent galling.

For Low Pressure

# TSP CUPLA Socket with Ball Valve

For low pressure general applications

<b>Working pressure</b> 1.0 1.0 MPa (10 kgf/cm <sup>2</sup> )	<b>Valve structure</b> One-way shut-off	<b>Applicable fluids</b> Water Hydraulic oil Air Gas
--	--	--

**One-piece design of TSP CUPLA socket and ball valve. Separation prevention mechanism prevents accidental disconnection during connection. (when the valve is open.)**

- Socket valve can be opened and shut off while socket and plug are connected.
- Ball valve design provides for high flow rate.
- High viscosity fluids such as grease can be applied.

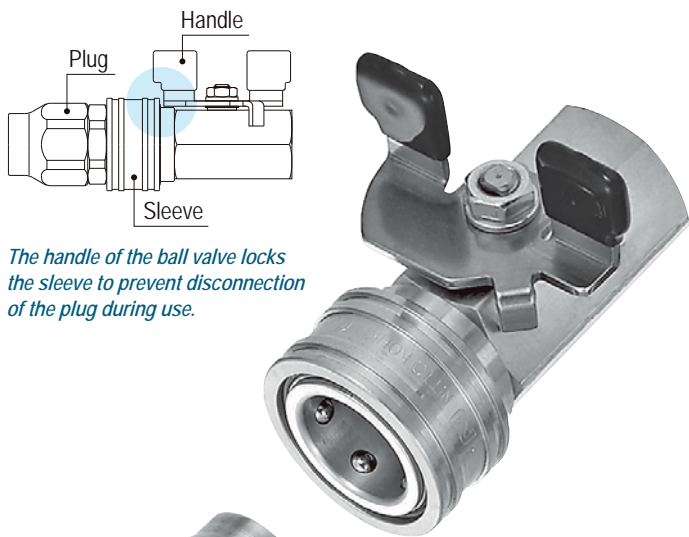

The handle of the ball valve locks the sleeve to prevent disconnection of the plug during use.

Interchangeable with standard TSP CUPLA plug in the same size.



Specifications					
Model	BV-2TSF	BV-3TSF	BV-4TSF	BV-6TSF	BV-8TSF
Size (Thread)	1/4"	3/8"	1/2"	3/4"	1"
Body material	Brass				
Pressure unit	MPa	kgf/cm <sup>2</sup>	bar	PSI	
Working pressure	1.0	10	10	145	
Seal material		Seal material	Mark	Working temperature range	
Working temperature range <sup>*1</sup>	CUPLA Part	Fluoro rubber	FKM	-5°C to +120°C	
	Ball Valve Part	Fluoropolymer resin	-		

\*1: The operable temperature range depends on the operating conditions.

Maximum Tightening Torque					Nm {kgf·cm}
Model	BV-2TSF	BV-3TSF	BV-4TSF	BV-6TSF	BV-8TSF
Torque	9 {92}	12 {122}	30 {306}	50 {510}	65 {663}

**Flow Direction**

Fluid flow can be bi-directional when socket and plug are connected.

**Interchangeability**  
TSP CUPLA plugs of the same size can be connected regardless of end configurations.

Minimum Cross-Sectional Area					(mm <sup>2</sup> )
Model	BV-2TSF	BV-3TSF	BV-4TSF	BV-6TSF	BV-8TSF
Min. cross-sectional area	19.6	44.1	63.6	122	201

\* Value of BV type only. The minimum cross-sectional area may vary depending upon the end configuration of the plug.

**Suitability for Vacuum**  
Not suitable for vacuum application in either connected or disconnected condition.

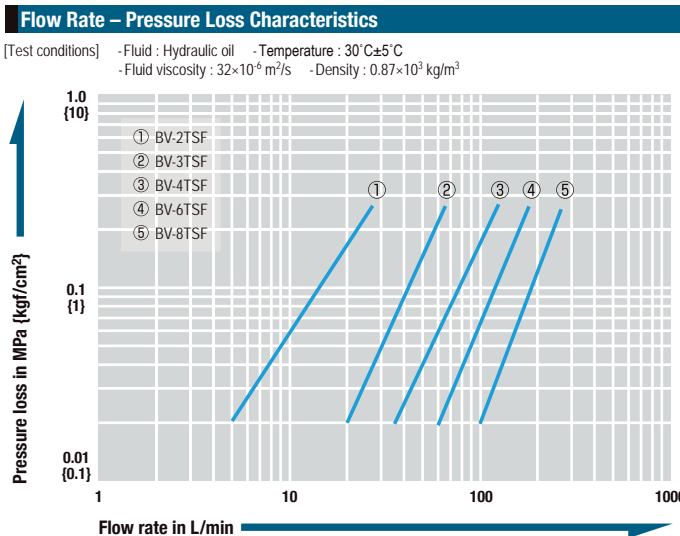

**Ball Valve Open**

Sleeve is locked.

**Ball Valve Shut**

Sleeve is free.



Models and Dimensions

WAF: WAF stands for width across flats.

Socket BV-TSF type (Female thread)

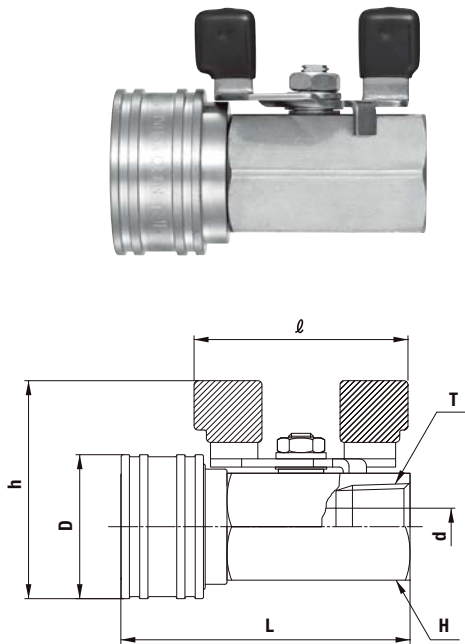

Model	Application (Thread)	Mass (g)	Dimensions (mm)						
			L	h	øD	H(WAF)	T	ød	ℓ
BV-2TSF	R 1/4	104	(52.3)	(43)	24	Hex.17	Rc 1/4	5	(38.5)
BV-3TSF	R 3/8	163	(60.5)	(47.5)	28	Hex.21	Rc 3/8	7.5	(44)
BV-4TSF	R 1/2	270	(70.3)	(53)	35	Hex.26	Rc 1/2	9	(52)
BV-6TSF	R 3/4	491	(82.8)	(66.1)	45	Hex.32	Rc 3/4	12.5	(60.5)
BV-8TSF	R 1	904	(102.3)	(76.6)	58	Hex.41	Rc 1	16	(76)

Application

TSP CUPLA Socket with Ball Valve

TSP CUPLA Socket + Commercially Available Ball Valve

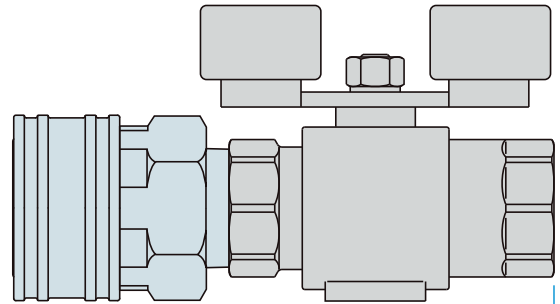

Overall length reduced by around 30%

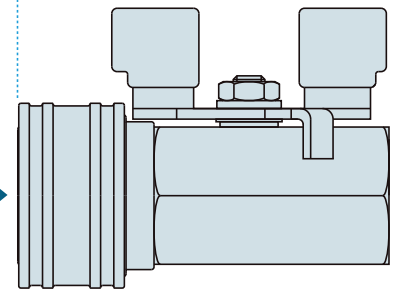

Compact and enhanced sealing design

Connection part between a Standard TSP CUPLA socket and a commercially available ball valve is eliminated for enhanced sealing and the overall length is reduced by around 30%.

Accessory

CUPLA ADAPTER for Braided Hose Connection

Can be screwed into CUPLA with female threads, 3/8", 1/2", 3/4"



See page 166 for the details.



For Medium Pressure

# SP CUPLA Type A

For medium pressure general applications

Working pressure



Valve structure



Applicable fluids



Note: Depending on the temperature of steam / hot water, the heat may damage seal materials.

For medium pressure applications, with automatic shut-off valves in both socket and plug. Various body materials, sizes and end configurations. Plugs with male thread end are also available.

- Automatic shut-off valves in both socket and plug prevent fluid spill out on disconnection.
- Available in various standard body materials, sizes and end configurations to cope with diversified applications and operating situations.



## New self-aligned valve design provides better seal

The new design of the valve head makes smooth self-aligned return to its original position when socket and plug are disconnected. This mechanism enhances safety sealing of individual socket or plug when disconnected (1 to 8SP-A Type).



Specifications										
Body material		Brass				Stainless steel (SUS304), Steel (Nickel plated)				
Size (Thread)		1/8", 1/4" 3/8"	1/2", 3/4" 1"	1 1/4" 1 1/2"	2"	1/8", 1/4" 3/8"	1/2", 3/4" 1"	1 1/4" 1 1/2"	2"	
Working pressure		MPa	5.0	3.0	2.0	1.5	7.5	4.5	3.0	2.0
		kgf/cm <sup>2</sup>	51	31	20	15	76	46	31	20
		bar	50	30	20	15	75	45	30	20
		PSI	725	435	290	218	1090	653	435	290
Seal material <sup>1</sup> Working temperature range <sup>2</sup>		Seal material	Nitrile rubber		Mark	NBR		Working temperature range	-20°C to +80°C	
			Fluoro rubber		Mark	FKM		Working temperature range	-20°C to +180°C	
			Ethylene-propylene rubber		Mark	EPDM		Working temperature range	-40°C to +150°C	
								Standard material		

<sup>1</sup>: Plugs with male thread with nitrile rubber or ethylene-propylene rubber are made-to-order items.

<sup>1</sup>: Seal material available for steel body is nitrile and fluoro rubber.

<sup>2</sup>: The operable temperature range depends on the operating conditions.

Maximum Tightening Torque										
		Nm {kgf·cm}								
Size (Thread)		1/8"	1/4"	3/8"	1/2"	3/4"	1"	1 1/4"	1 1/2"	2"
Torque	Steel	9 {92}	14 {143}	22 {224}	60 {612}	90 {918}	120 {1224}	260 {2652}	280 {2856}	500 {5100}
	Brass	5 {51}	9 {92}	12 {122}	30 {306}	50 {510}	65 {663}	150 {1530}	180 {1836}	260 {2652}
	Stainless steel	9 {92}	14 {143}	22 {224}	60 {612}	90 {918}	120 {1224}	260 {2652}	280 {2856}	500 {5100}

Plug with male thread type is only available in brass material.

### Flow Direction

Fluid flow can be bi-directional when socket and plug are connected.

### Interchangeability

Socket and plug of different sizes cannot be connected.  
Interchangeable with conventional SP CUPLA in the same size.  
<sup>\*</sup>Can be connected with SP-V CUPLA but take heed of flow rate change.

Minimum Cross-Sectional Area (mm <sup>2</sup> )									
Model	1SP-A	2SP-A	3SP-A	4SP-A	6SP-A	8SP-A	10SP-A	12SP-A	16SP-A
Min. Cross-sectional area	14	26	51	73	178	229	395	553	803

Suitability for Vacuum 1.3×10 <sup>-1</sup> Pa {1×10 <sup>-3</sup> mmHg}		
Socket only	Plug only	When connected
-	-	Operational

Admixture of Air on Connection May vary depending upon the usage conditions. (mL)									
Model	1SP-A	2SP-A	3SP-A	4SP-A	6SP-A	8SP-A	10SP-A	12SP-A	16SP-A
Volume of air admixture	0.6	1.1	2.7	3.9	11	17	29	45	84

Volume of Spillage per Disconnection May vary depending upon the usage conditions. (mL)									
Model	1SP-A	2SP-A	3SP-A	4SP-A	6SP-A	8SP-A	10SP-A	12SP-A	16SP-A
Volume of spillage	0.4	0.8	2.1	3.4	9.5	15	29	45	84

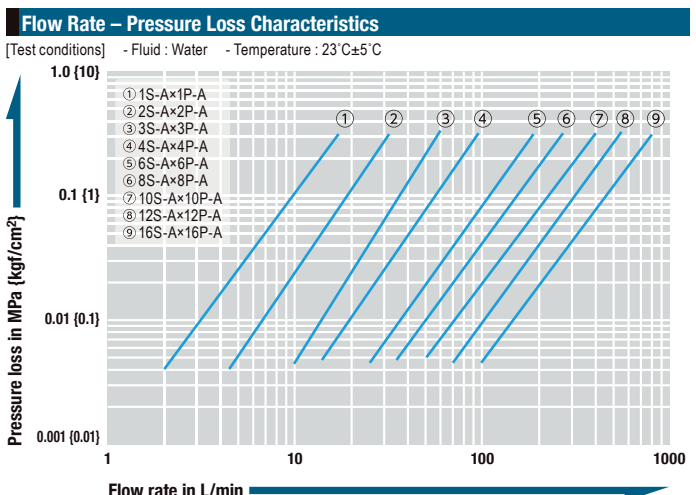

Models and Dimensions

**Plug Female thread**

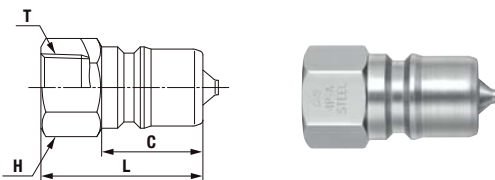

Model	Application (Thread)	Mass (g)			Dimensions (mm)			
		Steel	Brass	Stainless steel	L	C	H(WAF)	T
1P-A	R 1/8	17 *1	19	17	29	19	Hex.14	Rc 1/8
2P-A	R 1/4	32	34	32	36	22	Hex.17	Rc 1/4
3P-A	R 3/8	56	61	56	40	25	Hex.21	Rc 3/8
4P-A	R 1/2	112	121	112	44	28	Hex.29	Rc 1/2
6P-A	R 3/4	190	205	190	52	36	Hex.35	Rc 3/4
8P-A	R 1	311	333	310	62	40	Hex.41	Rc 1
10P-A	R 1 1/4	590	630	620	70	45	Hex.54 *2	Rc 1 1/4
12P-A	R 1 1/2	870	920	880	75	49	Hex.63 *3	Rc 1 1/2
16P-A	R 2	1540	1640	1560	80	52	77×ø84	Rc 2

\* The photos above show steel coupling. • The appearance of stainless steel coupling (SUS304) differs slightly from that shown in the photos above.

\*1 1P-A (Steel) and 1S-A (Steel) are made-to-order items. \*2 Stainless steel: 54×ø59 \*3 Stainless steel: 63×ø67

**Socket Female thread**

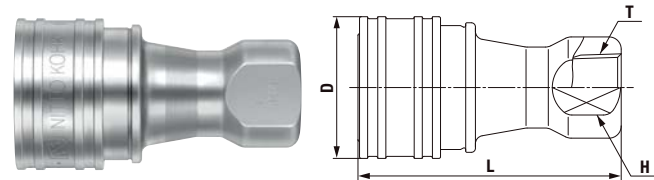

Model	Application (Thread)	Mass (g)			Dimensions (mm)			
		Steel	Brass	Stainless steel	L	øD	H(WAF)	T
1S-A	R 1/8	73 *1	79	75	48	24	14	Rc 1/8
2S-A	R 1/4	119	128	130	58	28	19	Rc 1/4
3S-A	R 3/8	187	202	193	65	35	21	Rc 3/8
4S-A	R 1/2	368	397	391	72	45	29	Rc 1/2
6S-A	R 3/4	639	686	645	88	55	35	Rc 3/4
8S-A	R 1	951	1024	962	102	65	41	Rc 1
10S-A	R 1 1/4	1430	1520	1440	115	77	54	Rc 1 1/4
12S-A	R 1 1/2	2130	2270	2150	124	88	63	Rc 1 1/2
16S-A	R 2	3280	3510	3310	132	108	77	Rc 2

**Plug Male thread**

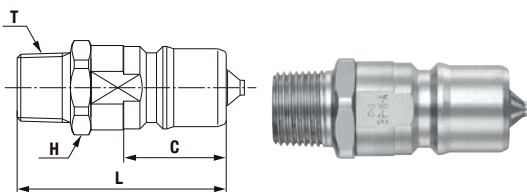

Model	Application (Thread)	Mass (g)	Dimensions (mm)			
		Brass	L	C	H(WAF)	T
1P-M-A	Rc 1/8	24	(40)	19	Hex.14	R 1/8
2P-M-A	Rc 1/4	41	(44)	22	Hex.17	R 1/4
3P-M-A	Rc 3/8	71	(51)	25	Hex.21	R 3/8
4P-M-A	Rc 1/2	149	(62)	28	Hex.27	R 1/2
6P-M-A	Rc 3/4	295	(75)	36	Hex.35	R 3/4
8P-M-A	Rc 1	406	(83)	40 *4	Hex.41	R 1

\*4 Model 8P-M-A indicates an approximate insertion length because there is no difference in level on the body.

Accessory

**CUPLA ADAPTER for Braided Hose Connection**

Can be screwed into CUPLA with female threads, 3/8", 1/2", 3/4"



See page 166 for the details.

**SLEEVE STOPPER for SP CUPLA Type A**

Sleeve stopper exclusively for SP CUPLA Type A sockets. Attaching the sleeve stopper after connection of socket and plug locks the sleeve of the socket and prevents unexpected disconnection.

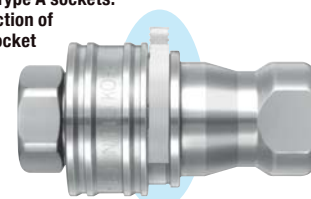
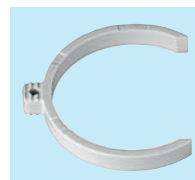

Attached to SP CUPLA Type A

See page 165 for the details.

Related product

For Medium Pressure / Connectable with residual pressure [With Purge Valve]

**SP CUPLA TypeA PV Type**

SP CUPLA Type A equipped with residual pressure eliminating valve.

- Automatic shut-off valves in both socket and plug prevent fluid spill out on disconnection.
- Smooth connection even when there is residual pressure when connecting.
- No residual pressure eliminating operation required on your piping. Just connect to purge the remaining pressure.



Made-to-order

**Purge Valve**

The small purge valve is pressed and completes the connection by releasing the residual pressure.

See page 161 for the details.

For Medium Pressure

# HOT WATER CUPLA HW Type

For temperature control piping

Working pressure



Valve structure



Applicable fluids\*

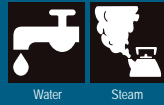

\* This product is designed for use with water from -20°C to +180°C. When used with other fluids, check the suitability of the seal and body material.

Employs sealing material with excellent heat resistance. Suitable for hot water applications such as plastic moldings.

- Separation prevention mechanism prevents accidental disconnection caused by vibration or impact.
- Nickel plated on the liquid contact parts to improve corrosion resistance.
- The socket has double O-ring for improved seal.



## Specifications

Body material	Brass (Nickel plated)			
Size (Thread)	Plug : R 1/4, R 3/8, R 1/2 / Socket : Rc 1/4, Rc 3/8, Rc 1/2			
Pressure unit	MPa	kgf/cm <sup>2</sup>	bar	PSI
Working pressure	2.0	20	20	290
Seal material	Seal material	Mark	Working temperature range	Remarks
Working temperature range <sup>1</sup>	Fluoro rubber	FKM	-20°C to +180°C	Standard material

<sup>1</sup>: The operable temperature range depends on the operating conditions.

## Maximum Tightening Torque

Size (Thread)	1/4"	3/8"	1/2"
Torque	9 {92}	12 {122}	30 {306}

On installation or removal always use correct size spanner / wrench on the hexagon section of socket/plug body.

## Flow Direction

Fluid flow can be bi-directional when socket and plug are connected.



## Interchangeability

Socket and plug of different sizes cannot be connected. SP CUPLA Type A and HW Type CUPLA of the same size can be connected regardless of end configurations. However, SP CUPLA Type A has different seal material characteristics, so the product specification and durability will differ. Conduct performance evaluation test under your actual operating environment and conditions within range of the working conditions of the product.

## Minimum Cross-Sectional Area

Model	HW-2S-F×HW-2P-M	HW-3S-F×HW-3P-M	HW-4S-F×HW-4P-M
Min. Cross-sectional area	26	51	73

## Suitability for Vacuum

1.3×10 <sup>-1</sup> Pa {1×10 <sup>-3</sup> mmHg}		
Socket only	Plug only	When connected
-	-	Operational

## Admixture of Air on Connection

Model	HW-2S-F×HW-2P-M	HW-3S-F×HW-3P-M	HW-4S-F×HW-4P-M
Volume of air	1.2	2.7	3.9

## Volume of Spillage per Disconnection

Model	HW-2S-F×HW-2P-M	HW-3S-F×HW-3P-M	HW-4S-F×HW-4P-M
Volume of spillage	0.8	2.1	3.2

## Flow Rate – Pressure Loss Characteristics

[Test conditions] - Fluid : Water - Temperature : 23°C±5°C

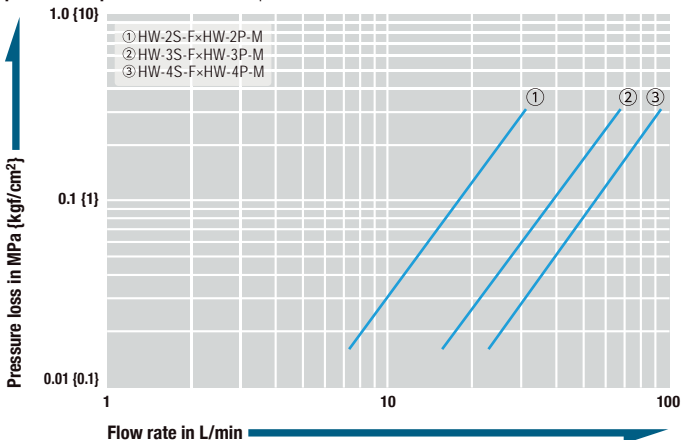

## Separation prevention mechanism (Safety lock)

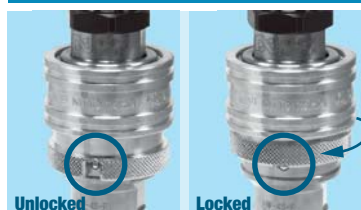

### How to lock

Slide the Lock Ring in the direction of the arrow A and rotate it simultaneously. When the Stopper is aligned with the shallower cutout on the Lock Ring, it will be in an inseparable state.

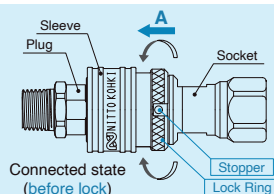

### How to unlock

Slide the Lock Ring in the direction of the arrow A and rotate it simultaneously. When the Stopper is aligned with the deeper cutout on the Lock Ring, it will be in a separable state.

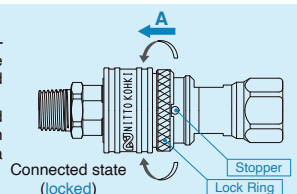

Models and Dimensions

Plug		Male thread						
Model	Application (Thread)	Mass (g)	Dimensions (mm)					
			L	C	øD	H (WAF)	T	
HW-2P-M	Rc 1/4	41	(44)	22	18.5	Hex.17	R 1/4	
HW-3P-M	Rc 3/8	71	(51)	25	23	Hex.21	R 3/8	
HW-4P-M	Rc 1/2	149	(62)	28	30	Hex.27	R 1/2	

Socket		Female thread						
Model	Application (Thread)	Mass (g)	Dimensions (mm)					
			L	øD	H (WAF)	T		
HW-2S-F	R 1/4	150	(66)	28	Hex.19	Rc 1/4		
HW-3S-F	R 3/8	247	(74)	35	Hex.24	Rc 3/8		
HW-4S-F	R 1/2	480	(87)	45	Hex.30	Rc 1/2		

Approximate time for Valve / O-ring replacement

\*Test results by us

Test conditions

• Testing device: Mold temperature controlling machine • Fluid: Clean water • Test temperature: 160°C, 180°C • Test condition: Continuous test with CUPLA connected

**Valve**

- when 180°C: Please replace whole CUPLA in approximately 1000 hours. The valve cannot be replaced.
- when 160°C: Please replace whole CUPLA in approximately 3000 hours. The valve cannot be replaced.

**O-ring**

- when 180°C: Please replace the O-rings of the Socket in approximately 700 hours. Please replace the two O-rings at once.
- when 160°C: Please replace the O-rings of the Socket in approximately 2000 hours. Please replace the two O-rings at once.

**Hot water 180°C**

Before test (unused) → After 1000 hours of use

**Hot water 160°C**

Before test (unused) → After 3000 hours of use

The packing starts to swell

Accessory  
O-ring (2 pieces/set)  
Please apply grease at the replacement.

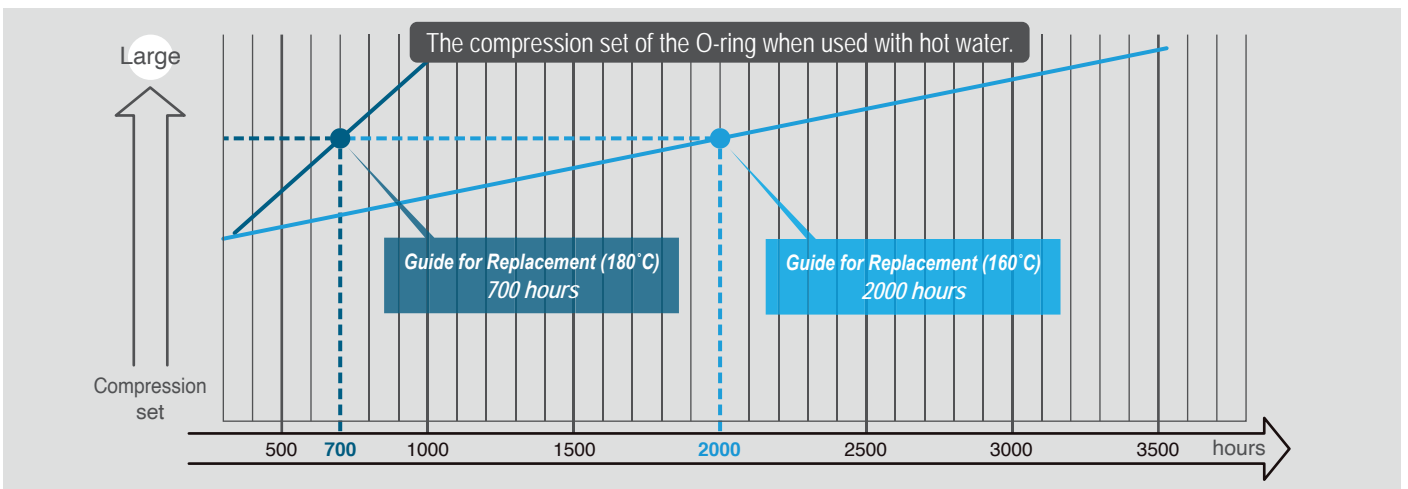

⚠ Caution

\*Hot water continuous flow test by a mold temperature controller

**Valve:** For continuous use of 3000 hours at 160°C / 1000 hours at 180°C

**O-ring:** For continuous use of 2000 hours at 160°C / 700 hours at 180°C

Although we have confirmed that there is no leakage, it is our experimental value and not a guaranteed value. Please consider above hours just as a guide. The durability of the seal differs depending on the customers usage conditions. (Number of connection / disconnection, fluid additives, etc.)







- Air will be admixed at the time of connection. Please purge the air by the equipment side when using with hot water.
- If additives are mixed in water or the piping is filled with steam, the lifetime of the seal will be decreased. When using in such an environment, conduct performance evaluation test by actual product.



For Medium Pressure

# ZEROSPILL CUPLA

Low spill type for medium pressure use

<b>Working pressure</b>	<b>Valve structure</b>	<b>Applicable fluids</b>				
 3.5 MPa (35 kgf/cm <sup>2</sup> )	 Two-way shut-off (Spill Reduction)	 Water	 Hydraulic oil	 Chemicals	 Air	 Gas

Unique seal design reduces both liquid spillage and air ingress.

- New valve design offers smooth zero-friction movement.
- Push to connect design.
- A variety of body materials and sizes have been standardized to support a wide range of applications and situations.
- Automatic shut-off valves in both socket and plug prevent fluid spill out on disconnection.



Specifications				
Body material	Brass		Stainless steel (SUS 304)	
Size (Thread)	1/4", 3/8", 1/2", 3/4", 1"			
Pressure unit	MPa	kgf/cm <sup>2</sup>	bar	PSI
Working pressure	3.5	36	36	508
Seal material Working temperature range *1	Seal material	Mark	Working temperature range	Remarks
	Nitrile rubber	NBR	-20°C to +80°C	Standard material
	Fluoro rubber	FKM	-20°C to +180°C	Standard material
	Ethylene-propylene rubber	EPDM	-40°C to +150°C	Standard material

\*1: The operable temperature range depends on the operating conditions.

Maximum Tightening Torque		Nm {kgf·cm}				
Size (Thread)		1/4"	3/8"	1/2"	3/4"	1"
Torque	Brass	9 (92)	12 (122)	30 (306)	50 (510)	65 (663)
	Stainless steel	14 (143)	22 (224)	60 (612)	90 (918)	120 (1224)

**Flow Direction**

Fluid flow can be bi-directional when socket and plug are connected.

**Interchangeability**

Socket and plug of different sizes cannot be connected.

Minimum Cross-Sectional Area (mm <sup>2</sup> )					
Model	ZEL-2SP	ZEL-3SP	ZEL-4SP	ZEL-6SP	ZEL-8SP
Min. cross-sectional area	31	60.5	86.5	160.6	188.7

Suitability for Vacuum 1.3×10 <sup>-1</sup> Pa {1×10 <sup>-3</sup> mmHg}		
Socket only	Plug only	When connected
-	-	Operational

Admixture of Air on Connection <small>May vary depending upon the usage conditions.</small> (mL)					
Model	ZEL-2SP	ZEL-3SP	ZEL-4SP	ZEL-6SP	ZEL-8SP
Volume of air admixture	0.16	0.21	0.37	1.12	1.52

Volume of Spillage per Disconnection <small>May vary depending upon the usage conditions.</small> (mL)					
Model	ZEL-2SP	ZEL-3SP	ZEL-4SP	ZEL-6SP	ZEL-8SP
Volume of spillage	0.06	0.12	0.20	0.43	0.55

\* Repeated connections and disconnections of CUPLA or the use of fluids with low viscosity may cause some spillage.

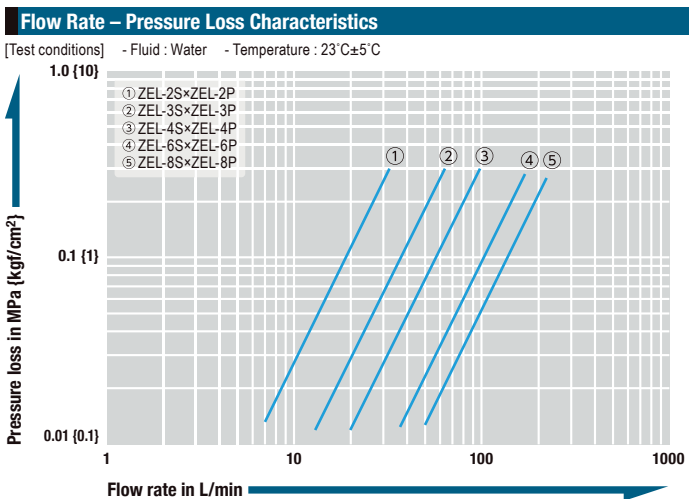



Models and Dimensions

**Plug Female thread**

Model	Application (Thread)	Mass (g)		Dimensions (mm)				
		Brass	Stainless steel	L	C	øD	H (WAF)	T
ZEL-2P	R 1/4	34	32	39	26.1	19	Hex.17	Rc 1/4
ZEL-3P	R 3/8	67	63	44.5	32	25	Hex.23	Rc 3/8
ZEL-4P	R 1/2	117	109	52.5	36.8	32	Hex.29	Rc 1/2
ZEL-6P	R 3/4	264	248	68.5	48	39.5	Hex.36	Rc 3/4
ZEL-8P	R 1	359	339	76.5	56	46	Hex.42	Rc 1

**Socket Female thread**

Model	Application (Thread)	Mass (g)		Dimensions (mm)			
		Brass	Stainless steel	L	øD	H (WAF)	T
ZEL-2S	R 1/4	133	125	(56)	28	Hex.21	Rc 1/4
ZEL-3S	R 3/8	255	239	(66)	35	Hex.27	Rc 3/8
ZEL-4S	R 1/2	404	382	(76)	42	Hex.32	Rc 1/2
ZEL-6S	R 3/4	829	784	(95.5)	55	Hex.42	Rc 3/4
ZEL-8S	R 1	1406	1326	(114.5)	65	Hex.50	Rc 1

\* The photos above show stainless steel model ZEL-8P and ZEL-8S. The profiles of brass couplings are the same as those of the stainless steel couplings.

# Main Features

## Unique seal design reduces both liquid spillage and air ingress

### To compare with SP CUPLA Type A.

**Volume of spillage:**  
about 96% less vs SP CUPLA Type A

**Volume of air ingress:**  
about 94% less vs SP CUPLA Type A

**SP CUPLA Type A**

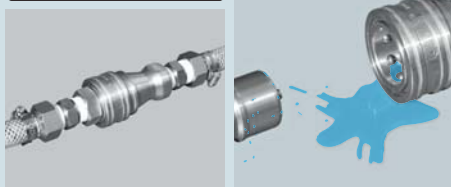

Connected

Disconnected

**ZEROSPILL CUPLA**

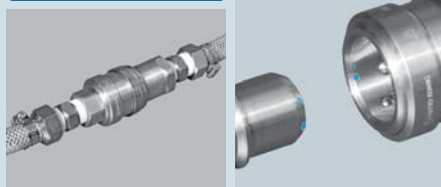

Connected

Disconnected



\*blue colored water is used to show volume of spillage clearly.

## Reliable zero friction valve

New valve design offers smooth zero-friction movement resulting in reduced chance of malfunction caused by deterioration of valve parts.

## Push-to-connect design One-hand easy operation

Just push the plug into the socket for simple and secure connection. This reduces connection time and improves efficiency.



Just push the plug into the socket

Simple and secure connection

### Accessory

## CUPLA ADAPTER for Braided Hose Connection

Can be screwed into CUPLA with female threads, 3/8", 1/2", 3/4"





See page 166 for the details.

For High Pressure

# HSP CUPLA

For hydraulic pressure from 14.0 to 20.6 MPa {142 to 210 kgf/cm<sup>2</sup>}

<p>Working pressure</p>  <p>14.0 to 20.6 MPa (142 to 210 kgf/cm<sup>2</sup>)</p>	<p>Valve structure</p>  <p>Two-way shut-off</p>	<p>Applicable fluid</p>  <p>Hydraulic oil</p>
--	--	--

Special steel body is tough against vibration and impact! Male and female thread end configurations are available. Low pressure loss characteristic suits hydraulic equipment applications.

- Quenched special steel body!
- Powerful impact resistance, especially against impulses.
- Automatic shut-off valves in both socket and plug prevent fluid spill out on disconnection.
- In addition to conventional female thread type, male thread types (male tapered thread, male parallel thread with 30° flare, and male parallel thread with 30° cone-seat) are available. Male thread types are designed especially for direct connection to hydraulic power units effectively.
- Male parallel thread type complies with both metal seal and O-ring seal. (In case of O-ring seal, O-rings available in the market can be used.)
- Optional HSP-DC CUPLA series are available for die-casting machine applications with severe pressure variation. (See page 158 of HSP-DC CUPLA for details.)
- The overall length of male thread type is shorter than that of female thread type plus conversion nipple available in the market.
- PL type (with separation prevention mechanism) for 2HS to 8HS (except 66HS) with female thread is also available as standard.

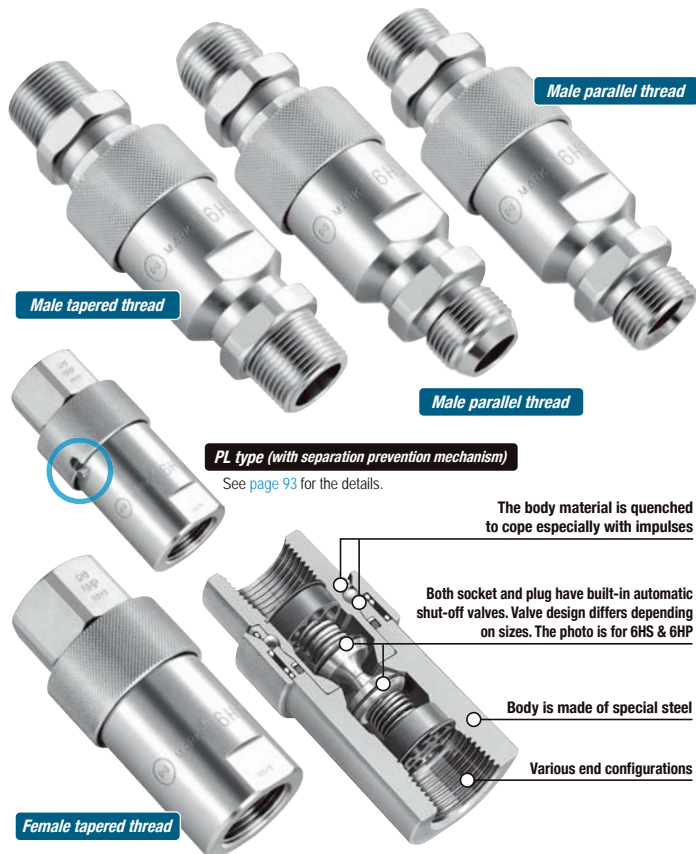

Specifications				
Body material	Special steel (Nickel plated)			
Size (Thread)	1/4", 3/8", 1/2", 3/4", 1"		1 1/4", 1 1/2"	
Working pressure	MPa	20.6	18.0	14.0
	kgf/cm <sup>2</sup>	210	183	142
	bar	206	180	140
	PSI	2990	2610	2030
Seal material	Seal material	Mark	Working temperature range	Remarks
Working temperature range <sup>*1</sup>	Nitrile rubber	NBR	-20°C to +80°C	Standard material
	Fluoro rubber	FKM	-20°C to +180°C	Available on request

\*1: The operable temperature range depends on the operating conditions.

Maximum Tightening Torque		Nm {kgf·cm}							
Size (Thread)		1/4"	3/8"	1/2"	3/4"	1"	1 1/4"	1 1/2"	2"
Torque	Female thread	28 {286}	45 {459}	90 {918}	100 {1020}	180 {1836}	290 {2958}	350 {3570}	500 {5100}
	Male taper thread	28 {286}	45 {459}	90 {918}	100 {1020}	-	-	-	-
	Parallel male thread	25 {255}	35 {357}	60 {612}	120 {1224}	-	-	-	-

**Flow Direction**

Fluid flow can be bi-directional when socket and plug are connected.

**Interchangeability**

4HSP with 6HSP or 10HSP with 12HSP can be connected with each other. Other combinations of different sizes are not connectable.

Minimum Cross-Sectional Area	(mm <sup>2</sup> )								
Model	2HSP	3HSP	4HSP	6HSP	66HSP	8HSP	10HSP	12HSP	16HSP
Minimum cross-sectional area	21	37	77	77	145	203	595	595	1084

Suitability for Vacuum	1.3×10 <sup>-1</sup> Pa {1×10 <sup>-3</sup> mmHg}		
Socket only	Plug only	When connected	
-	-	Operational	

Admixture of Air on Connection	May vary depending upon the usage conditions. (mL)								
Model	2HSP	3HSP	4HSP	6HSP	66HSP	8HSP	10HSP	12HSP	16HSP
Volume of air	0.7	1.9	3.5	3.5	8.2	12.4	44	44	156

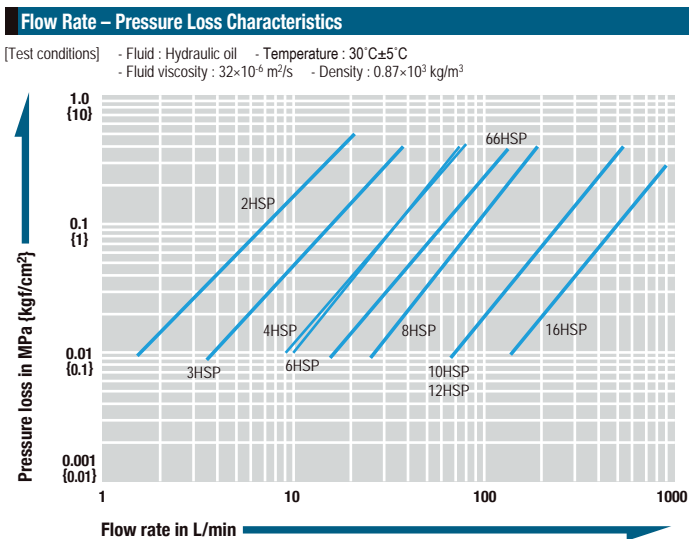

The flow volume of male thread type is increased by 5 to 10% compared with that of female thread type with conversion nipple.

**⚠ Precautions for use**

There is no interchangeability between HSP CUPLA and 210 CUPLA, 280 CUPLA or 450B CUPLA. Do not connect to each other even if sizes are similar.

Models and Dimensions

Product appearance may vary by size. / WAF : WAF stands for width across flats.

**Plug HP type (Female tapered thread)**

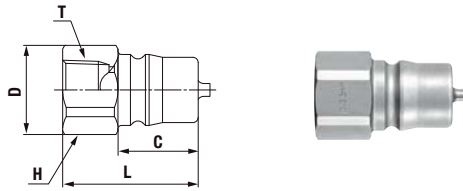

Model	Application (Thread)	Mass (g)	Dimensions (mm)				
			L	øD	C	H(WAF)	T
2HP	R 1/4	40	32	20.5	17.5	Hex.19	Rc 1/4
3HP	R 3/8	68	38	25	22.5	Hex.23	Rc 3/8
4HP	R 1/2	124	44	32	27.5	Hex.29	Rc 1/2
6HP	R 3/4	148	50	35	27.5	Hex.32	Rc 3/4
66HP	R 3/4	232	51	40	28	35	Rc 3/4
8HP	R 1	361	61	47	36	41	Rc 1
10HP	R 1 1/4	886	80	64	58	58	Rc 1 1/4
12HP	R 1 1/2	810	80	64	58	58	Rc 1 1/2
16HP	R 2	3307	115	100	83	90	Rc 2

**Plug HP-R type (Male tapered thread)**

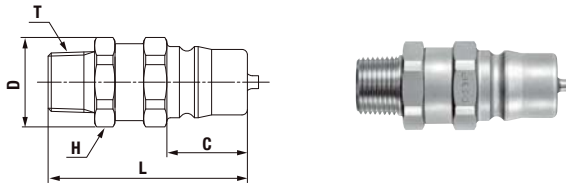

Model	Application (Thread)	Mass (g)	Dimensions (mm)				
			L	øD	C	H(WAF)	T
2HP-R	Rc 1/4	60	(49)	21	17.5	Hex.19	R 1/4
3HP-R	Rc 3/8	102	(55.5)	25	22.5	Hex.23	R 3/8
4HP-R	Rc 1/2	171	(63)	31	27.5	Hex.29	R 1/2
6HP-R	Rc 3/4	197	(66)	35	27.5	Hex.32	R 3/4

**Plug HP-GP type (Male parallel thread with 30° flare)**

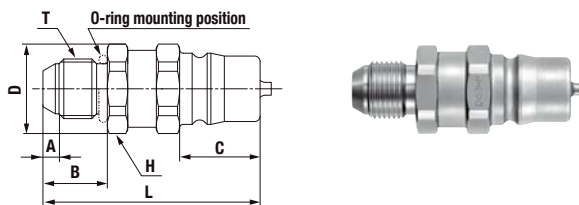

Model	Application* (Thread)	Mass (g)	O-ring size	Dimensions (mm)						
				L	øD	A	B	C	H(WAF)	T
2HP-GP	G 1/4	62	P-11	(52.5)	21	(4.5)	16	17.5	Hex.19	G 1/4B
3HP-GP	G 3/8	103	P-14	(60.5)	25	(4.5)	18	22.5	Hex.23	G 3/8B
4HP-GP	G 1/2	173	P-18	(66)	31	(5.5)	20	27.5	Hex.29	G 1/2B
6HP-GP	G 3/4	203	P-24	(69)	35	(5.5)	22	27.5	Hex.32	G 3/4B

**Plug HP-GS type (Male parallel thread with 30° cone-seat)**

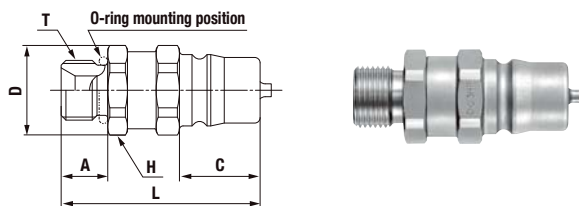

Model	Application* (Thread)	Mass (g)	O-ring size	Dimensions (mm)					
				L	øD	A	C	H(WAF)	T
2HP-GS	G 1/4	59	P-11	(48)	21	11.5	17.5	Hex.19	G 1/4B
3HP-GS	G 3/8	99	P-14	(55.5)	25	13	22.5	Hex.23	G 3/8B
4HP-GS	G 1/2	167	P-18	(60.5)	31	14.5	27.5	Hex.29	G 1/2B
6HP-GS	G 3/4	191	P-24	(63.5)	35	16.5	27.5	Hex.32	G 3/4B

**Socket HS type (Female tapered thread)**

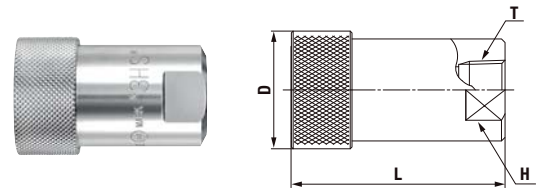

\*Models with separation prevention mechanism is also available. (Example of model name: 2HS with separation prevention mechanism → 2HS-PL)

Model	Application (Thread)	Mass (g)	Dimensions (mm)			
			L	øD	H(WAF)	T
2HS*	R 1/4	134	49	(27.5)	19	Rc 1/4
3HS*	R 3/8	226	60	(33)	23	Rc 3/8
4HS*	R 1/2	485	(72)	(43)	35	Rc 1/2
6HS*	R 3/4	460	(72)	(43)	35	Rc 3/4
66HS	R 3/4	569	78.5	(47)	35	Rc 3/4
8HS*	R 1	1042	93	(58)	46	Rc 1
10HS	R 1 1/4	2586	138	87	58	Rc 1 1/4
12HS	R 1 1/2	2510	138	87	58	Rc 1 1/2
16HS	R 2	7286	198	123	80	Rc 2

**Socket HS-R type (Male tapered thread)**

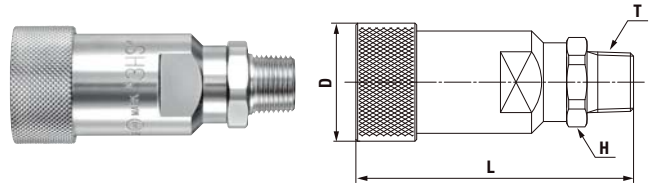

Model	Application (Thread)	Mass (g)	Dimensions (mm)			
			L	øD	H(WAF)	T
2HS-R	Rc 1/4	148	(66)	(27.5)	Hex.19	R 1/4
3HS-R	Rc 3/8	245	(77.5)	(33)	Hex.23	R 3/8
4HS-R	Rc 1/2	466	(90)	(43)	Hex.29	R 1/2
6HS-R	Rc 3/4	493	(93)	(43)	Hex.32	R 3/4

**Socket HS-GP type (Male parallel thread with 30° flare)**

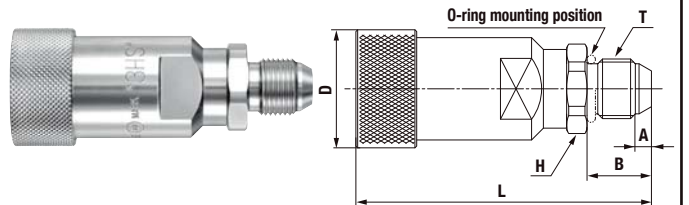

Model	Application* (Thread)	Mass (g)	O-ring size	Dimensions (mm)						
				L	øD	A	B	H(WAF)	T	
2HS-GP	G 1/4	149	P-11	(69.5)	(27.5)	(4.5)	16	Hex.19	G 1/4B	
3HS-GP	G 3/8	246	P-14	(82.5)	(33)	(4.5)	18	Hex.23	G 3/8B	
4HS-GP	G 1/2	476	P-18	(93)	(43)	(5.5)	20	Hex.29	G 1/2B	
6HS-GP	G 3/4	498	P-24	(96)	(43)	(5.5)	22	Hex.32	G 3/4B	

**Socket HS-GS type (Male parallel thread with 30° cone-seat)**

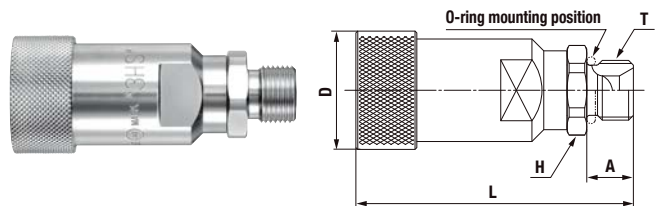

Model	Application* (Thread)	Mass (g)	O-ring size	Dimensions (mm)					
				L	øD	A	H(WAF)	T	
2HS-GS	G 1/4	146	P-11	(65)	(27.5)	11.5	Hex.19	G 1/4B	
3HS-GS	G 3/8	242	P-14	(77.5)	(33)	13	Hex.23	G 3/8B	
4HS-GS	G 1/2	469	P-18	(87.5)	(43)	14.5	Hex.29	G 1/2B	
6HS-GS	G 3/4	485	P-24	(90)	(43)	16.5	Hex.32	G 3/4B	

\*The counterpart of GP type must be the female parallel thread specified in JIS B 8363 with 30° cone-seat or the coupling with O-ring seal. The counterpart of GS type must be the female parallel thread JIS B 8363 with 30° flare or the coupling with O-ring seal. - Sleeve stopper design is available for models 2HS to 8HS (except 66HS).

# HSP CUPLA **PL Type**

Easy to operate separation prevention mechanism enhances operator safety.



**Locked**

Separation prevention mechanism is easily locked by turning the sleeve after connection.

## Models and Dimensions Product appearance may vary by size. / WAF: WAF stands for width across flats.

### Socket HS-PL type (Female tapered thread)

With separation prevention mechanism

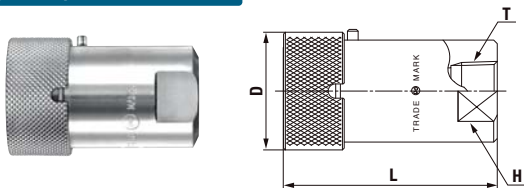

Model	Application (Thread)	Mass (g)	Dimensions (mm)			
			L	øD	H (WAF)	T
2HS-PL	R 1/4	134	49	(27.5)	19	Rc 1/4
3HS-PL	R 3/8	226	60	(33)	23	Rc 3/8
4HS-PL	R 1/2	485	(72)	(43)	35	Rc 1/2
6HS-PL	R 3/4	460	(72)	(43)	35	Rc 3/4
8HS-PL	R 1	1042	93	(58)	46	Rc 1

### At connection

Align the cutout in the sleeve with the stopper, and pull the sleeve to connect the plug.

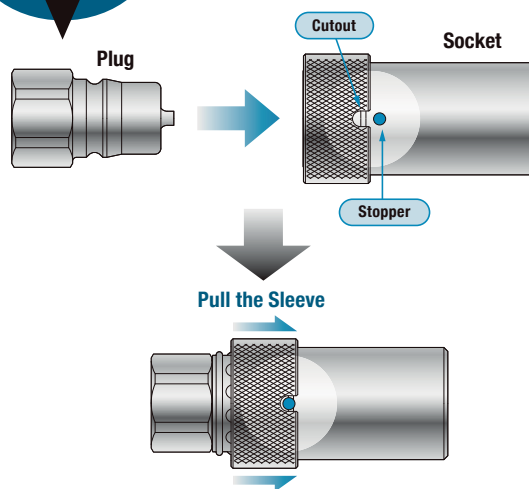

### Locking the sleeve

Without alignment of the cutout with the stopper, disconnection cannot be made.

**Accidental disconnection is prevented.**

Align the cutout in the sleeve with the stopper, and pull the sleeve to disconnect.

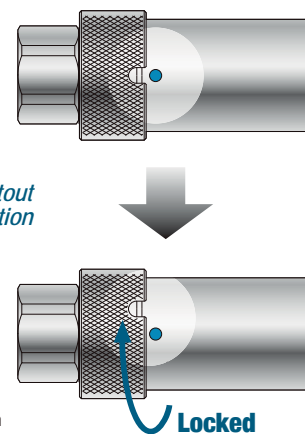

The stopper is marked with blue for visual understanding.

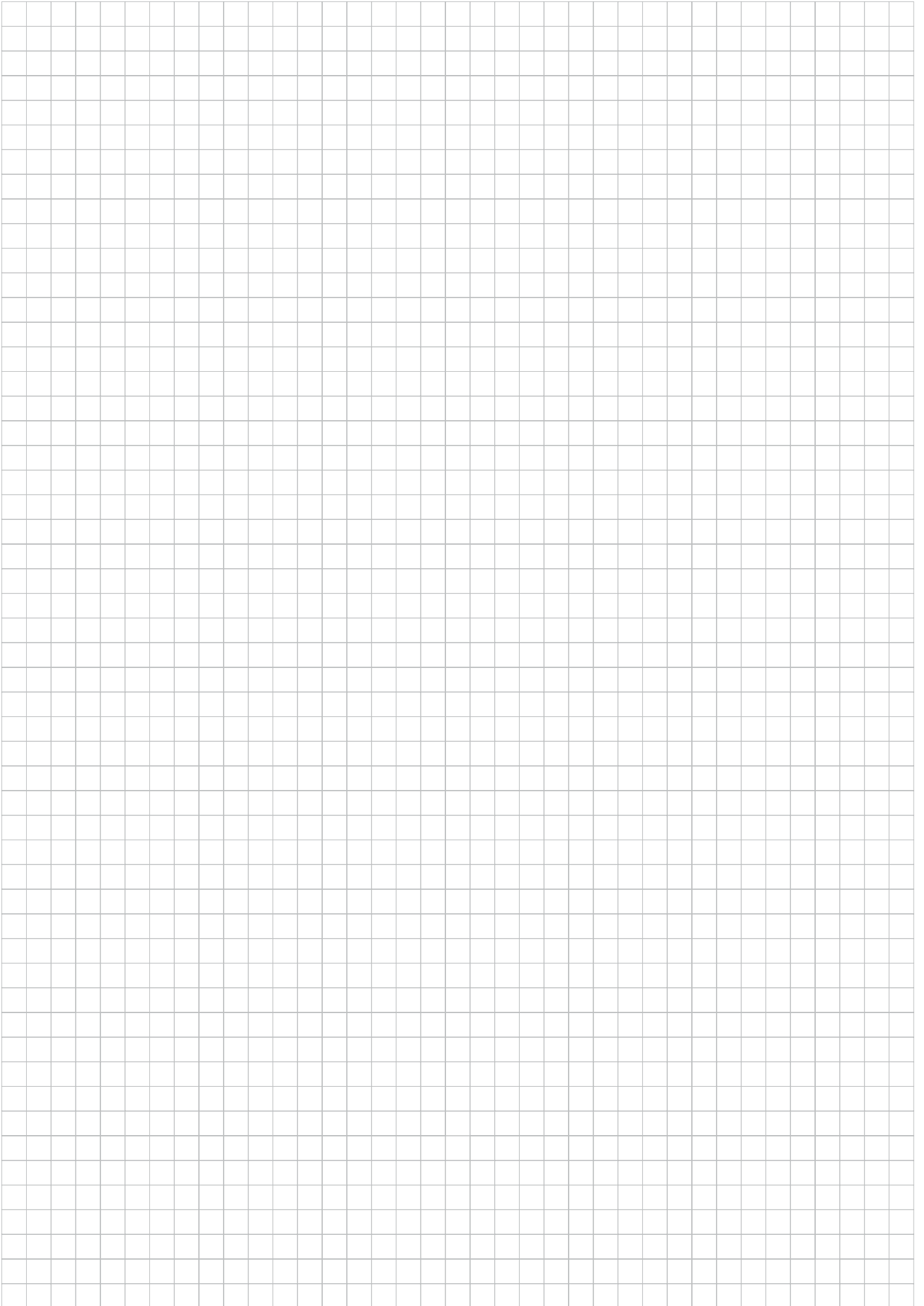



For High Pressure

# HYPER HSP CUPLA

Connects hydraulic piping even with residual pressure up to 20.6 MPa {210 kgf/cm<sup>2</sup>}

<p>Working pressure</p> <p>20.6 MPa (210 kgf/cm<sup>2</sup>)</p>	<p>Valve structure</p> <p>Two-way shut-off</p>	<p>Applicable fluid</p> <p>Hydraulic oil</p>
--	--	--

Purge function will set you free from the troublesome residual pressure elimination before connection and let you achieve efficient and frequent hydraulic pipe line coupling.

- Both socket and plug have built-in automatic shut-off valves to prevent fluid spill out when disconnected.
- Interchangeable with standard HSP CUPLA plug or socket in the same size.

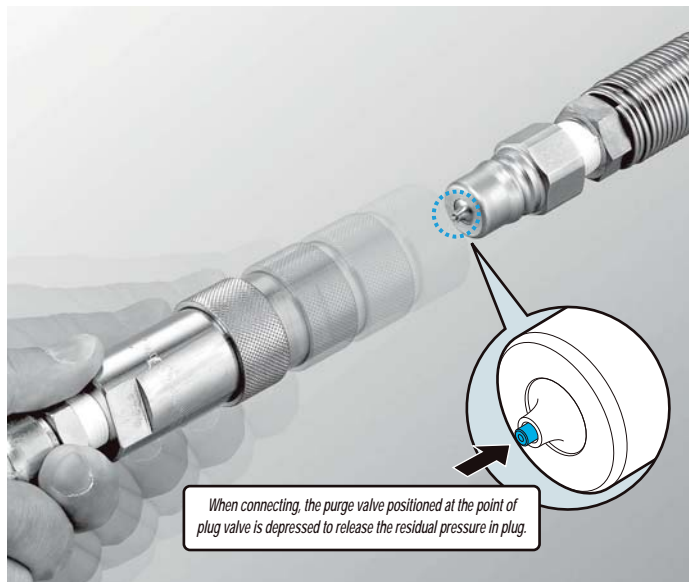

Specifications				
Body material	Special steel (Nickel plated)			
Size (Thread)	1/4", 3/8", 1/2", 3/4", 1"			
Pressure unit	MPa	kgf/cm <sup>2</sup>	bar	PSI
Working pressure	20.6	210	206	2990
Seal material	Seal material	Mark	Working temperature range	Remarks
Working temperature range <sup>1</sup>	Nitrile rubber	NBR	-20°C to +80°C	Standard material

<sup>1</sup>: The operable temperature range depends on the operating conditions.

Maximum Tightening Torque		Nm {kgf·cm}				
Size (Thread)		1/4"	3/8"	1/2"	3/4"	1"
Torque		28 {286}	45 {459}	90 {918}	100 {1020}	180 {1836}

**Flow Direction**

Fluid flow can be bi-directional when socket and plug are connected.

**Interchangeability**

Interchangeable with standard HSP CUPLA plug or socket in the same size. Avoid connecting HYPER HSP CUPLA socket with HYPER HSP CUPLA plug. The residual pressure will not release.

Minimum Cross-Sectional Area		(mm <sup>2</sup> )				
Model		2HP-PV/2HS-PV	3HP-PV/3HS-PV	4HP-PV/4HS-PV	6HP-PV/6HS-PV	8HP-PV/8HS-PV
Minimum cross-sectional area		21	37	77	77	203

Suitability for Vacuum		1.3×10 <sup>-1</sup> Pa {1×10 <sup>-3</sup> mmHg}	
Socket only		Plug only	When connected
-		-	Operational

Admixture of Air on Connection		May vary depending upon the usage conditions.				(mL)	
Model		2HP-PV/2HS-PV	3HP-PV/3HS-PV	4HP-PV/4HS-PV	6HP-PV/6HS-PV	8HP-PV/8HS-PV	
Volume of air		0.7	1.9	3.5	3.5	12.4	

Connection Load under Residual Pressure (For reference)		(N)				
Residual pressure / Model		2HP-PV/2HS-PV	3HP-PV/3HS-PV	4HP-PV/4HS-PV	6HP-PV/6HS-PV	8HP-PV/8HS-PV
at 5.0 MPa		50	85	85	85	100
at 10.0 MPa		70	85	85	85	130
at 15.0 MPa		100	100	100	100	170

**Flow Rate – Pressure Loss Characteristics**

[Test conditions] - Fluid : Hydraulic oil - Temperature : 30°C±5°C  
 - Fluid viscosity : 32×10<sup>-6</sup> m<sup>2</sup>/s - Density : 0.87×10<sup>3</sup> kg/m<sup>3</sup>

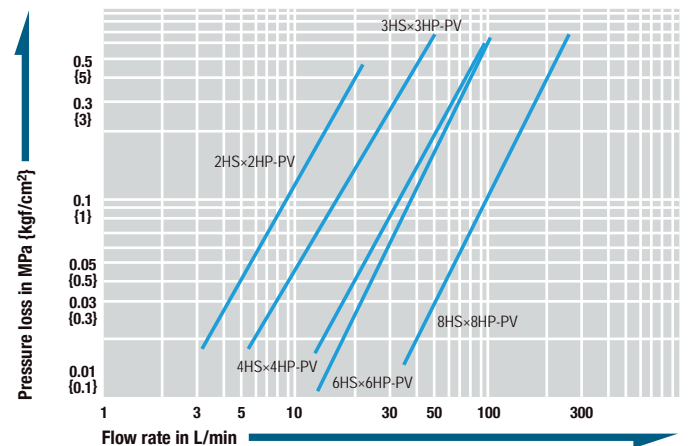

Note: Either socket or plug of HYPER HSP CUPLA must be used on the line where the residual pressure remains. The counterpart of HYPER HSP must be either plug or socket of standard HSP CUPLA.

**⚠ Precautions for use**

There is no interchangeability between HSP CUPLA and 210 CUPLA, 280 CUPLA or 450B CUPLA. Do not connect to each other even if sizes are similar.

Models and Dimensions

**Plug** HP type (Female thread)

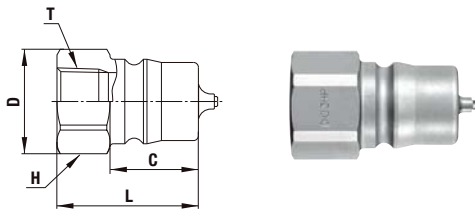

Model	Application (Thread)	Mass (g)	Dimensions (mm)				
			L	øD	C	H(WAF)	T
2HP-PV	R 1/4	44	32	20.5	17.5	Hex.19	Rc 1/4
3HP-PV	R 3/8	72	38	25	22.5	Hex.23	Rc 3/8
4HP-PV	R 1/2	138	44	32	27.5	Hex.29	Rc 1/2
6HP-PV	R 3/4	147	50	35	27.5	Hex.32	Rc 3/4
8HP-PV	R 1	360	61	47	36	41	Rc 1

**Socket** HS type (Female thread)

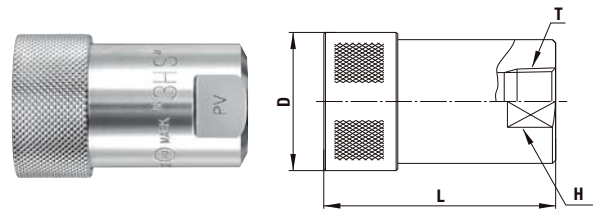

Model	Application (Thread)	Mass (g)	Dimensions (mm)			
			L	øD	H(WAF)	T
2HS-PV	R 1/4	136	49	(27.5)	19	Rc 1/4
3HS-PV	R 3/8	225	60	(33)	23	Rc 3/8
4HS-PV	R 1/2	485	(72)	(43)	35	Rc 1/2
6HS-PV	R 3/4	460	(72)	(43)	35	Rc 3/4
8HS-PV	R 1	1050	93	(58)	46	Rc 1

**Residual Pressure Release (or purge) Mechanism**

While connecting, the purge valve indicated with a circle is being pushed and releasing the residual pressure

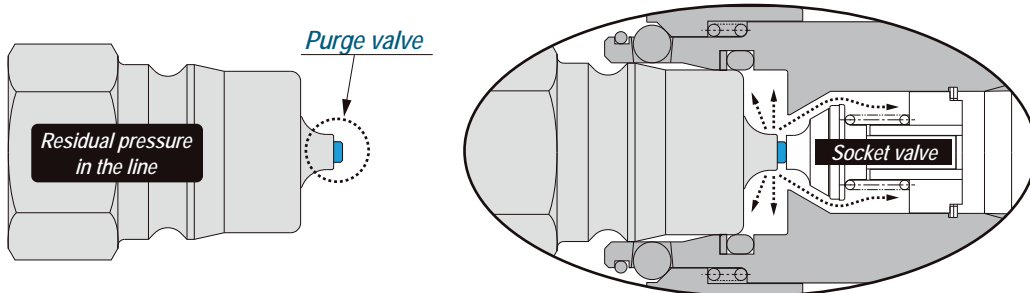



**Note:** Either socket or plug of HYPER HSP CUPLA must be used on the line where the residual pressure remains. The counterpart of HYPER HSP must be either plug or socket of standard HSP CUPLA. HYPER HSP CUPLA can be connected under the residual pressure in the line, but cannot during pressurizing. It may lead to incomplete connection, durability deterioration or possible valve fly out.

For High Pressure

# 210 CUPLA

For hydraulic pressure up to 20.6 MPa {210 kgf/cm<sup>2</sup>}

<p>Working pressure</p>  <p>20.6 MPa (210 kgf/cm<sup>2</sup>)</p>	<p>Valve structure</p>  <p>Two-way shut-off</p>	<p>Applicable fluid</p>  <p>Hydraulic oil</p>
---	--	--

**Hydraulic CUPLA for general purposes with a working pressure up to 20.6 MPa. Low pressure loss, suitable for hydraulic equipment.**

- Hydraulic CUPLA with a working pressure of 20.6 MPa {210 kgf/cm<sup>2</sup>}.
- Structure is designed to reduce pressure loss to the lowest, and is suitable for hydraulic applications that need big flow rates.
- Both socket and plug have built-in automatic shut-off valves that prevent fluid outflow when disconnected.

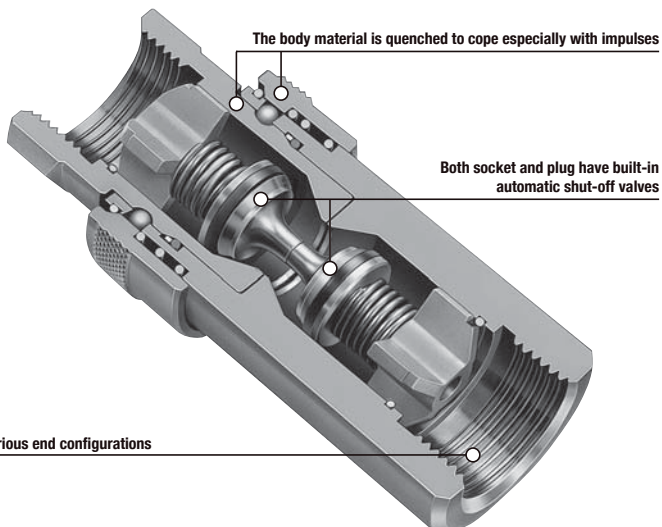

Specifications				
Body material	Special steel (Nickel plated)			
Size (Thread)	1/4", 3/8", 1/2", 3/4", 1"			
Pressure unit	MPa	kgf/cm <sup>2</sup>	bar	PSI
Working pressure	20.6	210	206	2990
Seal material Working temperature range <sup>*1</sup>	Seal material	Mark	Working temperature range	Remarks
	Nitrile rubber	NBR	-20°C to +80°C	Standard material
	Fluoro rubber	FKM	-20°C to +180°C	Available on request

\*1: The operable temperature range depends on the operating conditions.

Maximum Tightening Torque		Nm {kgf·cm}				
Size (Thread)		1/4"	3/8"	1/2"	3/4"	1"
Torque		28 (286)	45 (459)	90 (918)	100 (1020)	180 (1836)

**Flow Direction**

Fluid flow can be bi-directional when socket and plug are connected.

**Interchangeability**

Socket and plug of different sizes cannot be connected.

Minimum Cross-Sectional Area	(mm <sup>2</sup> )				
Model	210-2SP	210-3SP	210-4SP	210-6SP	210-8SP
Minimum cross-sectional area	24.5	42.8	77.4	146.5	235.6

**Suitability for Vacuum** 1.3 Pa {1×10<sup>-2</sup> mmHg}

Socket only	Plug only	When connected
-	-	Operational

**Admixture of Air on Connection** *May vary depending upon the usage conditions.* (mL)

Model	210-2SP	210-3SP	210-4SP	210-6SP	210-8SP
Volume of air	0.85	1.02	2.63	8.83	16.04

**Flow Rate – Pressure Loss Characteristics**

[Test conditions] - Fluid : Hydraulic oil - Temperature : 30°C±5°C  
 - Fluid viscosity : 32×10<sup>-6</sup> m<sup>2</sup>/s - Density : 0.87×10<sup>3</sup> kg/m<sup>3</sup>

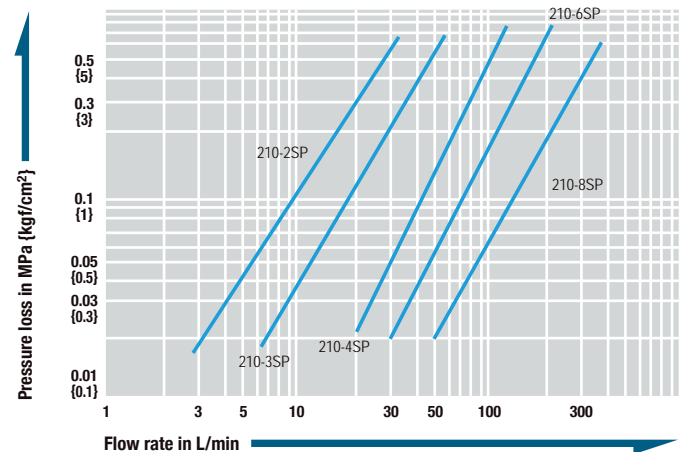

**⚠ Precautions for use**

There is no interchangeability between 210 CUPLA and HSP CUPLA, 280 CUPLA or 450B CUPLA. Do not connect each other even if some sizes are approximate.

**Plug Female thread**

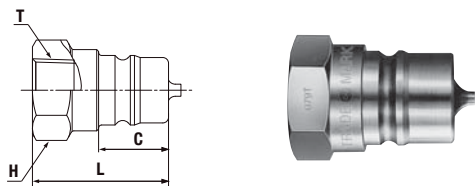

Model	Application (Thread)	Mass (g)	Dimensions (mm)			
			L	C	H(WAF)	T
210-2P	R 1/4	39	33	18	Hex.19	Rc 1/4
210-3P	R 3/8	57	36	18.5	Hex.23	Rc 3/8
210-4P	R 1/2	90	42.5	24	Hex.27	Rc 1/2
210-6P	R 3/4	195	51	28	Hex.35	Rc 3/4
210-8P	R 1	293	61	35	Hex.41	Rc 1

**Socket Female thread**

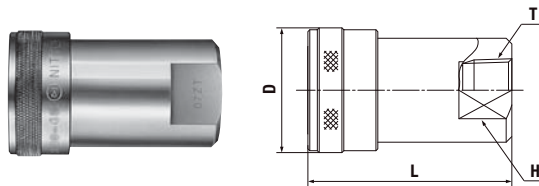

Model	Application (Thread)	Mass (g)	Dimensions (mm)			
			L	øD	H(WAF)	T
210-2S	R 1/4	158	50.5	(30)	22	Rc 1/4
210-3S	R 3/8	193	54	(33)	23	Rc 3/8
210-4S	R 1/2	330	65	(39)	29	Rc 1/2
210-6S	R 3/4	566	78.5	(48)	35	Rc 3/4
210-8S	R 1	861	95	(55)	41	Rc 1

**Application Example**

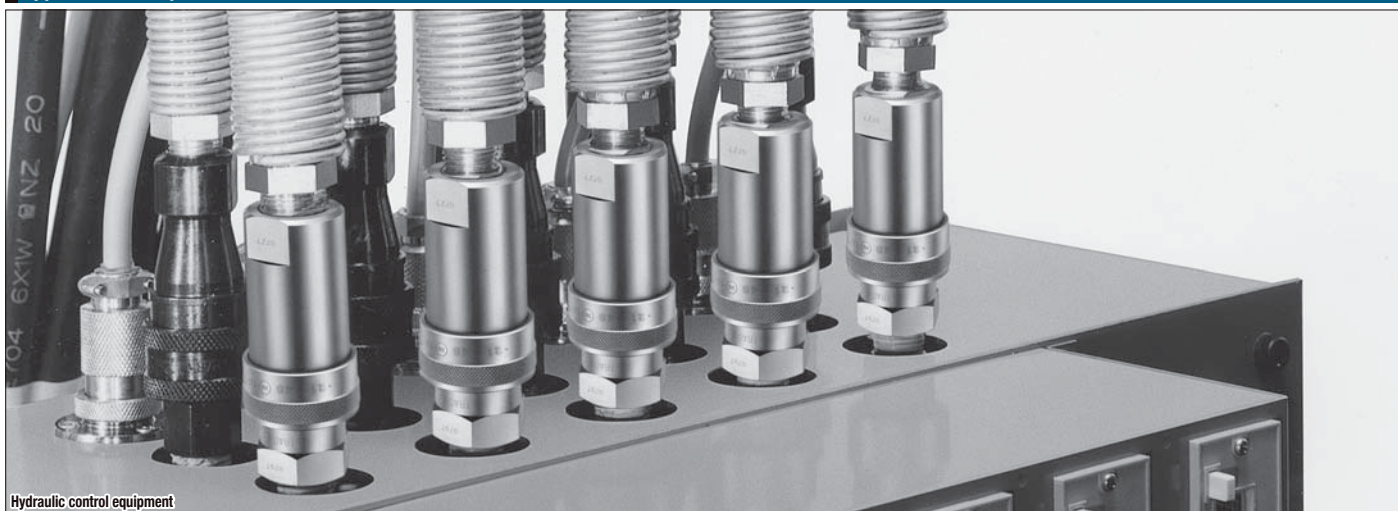

Hydraulic control equipment







Construction machinery



For High Pressure

# HSU CUPLA

Stainless steel CUPLA for high pressure up to 21.0 MPa {214 kgf/cm<sup>2</sup>}

<b>Working pressure</b>	<b>Valve structure</b>	<b>Applicable fluids</b>		
 21.0 MPa (214 kgf/cm <sup>2</sup> )	 Two-way shut-off			
		Water	Hydraulic oil	Gas

The flow volume is increased by between 14 to 44% while at the same time the coupled length is reduced by at least 10% compared with the S210 CUPLA.

- Body material is excellent corrosion resistant stainless steel (SUS304). Suitable for use in tough/harsh environments such as offshore applications.
- Separation prevention mechanism is easily locked by turning the sleeve after connection.
- Despite having a stainless steel body, the working pressure, 21.0 MPa, of HSU CUPLA is comparable to that of special steel body CUPLA such as HSP CUPLA series.
- Both socket and plug have built-in automatic shut-off valves that prevent fluid outflow on disconnection.
- Hydrogenated nitrile rubber (HNBR) is used as a seal material for wide variety of liquids.



Specifications				
Body material	Stainless steel (SUS304)			
Size (Thread)	1/4", 3/8", 1/2", 3/4", 1"			
Pressure unit	MPa	kgf/cm <sup>2</sup>	bar	PSI
Working pressure	21.0	214	210	3050
Seal material	Seal material		Mark	Working temperature range
Working temperature range <sup>*1</sup>	Hydrogenated nitrile rubber <sup>*2</sup>		HNBR	-20°C to +120°C

\*1: The operable temperature range depends on the operating conditions.  
\*2: The seal materials used in HSU CUPLA are not suitable for Freon gas.

Maximum Tightening Torque					
	Nm {kgf·cm}				
Size (Thread)	1/4"	3/8"	1/2"	3/4"	1"
Torque	28 {286}	35 {357}	70 {714}	100 {1020}	180 {1836}

**Flow Direction**

Fluid flow can be bi-directional when socket and plug are connected.



**Interchangeability**

Socket and plug of different sizes cannot be connected.

Minimum Cross-Sectional Area					
	(mm <sup>2</sup> )				
Model	HSU-2SP	HSU-3SP	HSU-4SP	HSU-6SP	HSU-8SP
Minimum cross-sectional area	27.1	48.2	84.2	143.6	221.2

Suitability for Vacuum		
1.3×10 <sup>-1</sup> Pa {1×10 <sup>-3</sup> mmHg}		
Socket only	Plug only	When connected
—	—	Operational

Admixture of Air on Connection					
May vary depending upon the usage conditions.					
(mL)					
Model	HSU-2SP	HSU-3SP	HSU-4SP	HSU-6SP	HSU-8SP
Volume of air admixture	0.7	1.5	3.6	6.3	10.9

Volume of Spillage per Disconnection					
May vary depending upon the usage conditions.					
(mL)					
Model	HSU-2SP	HSU-3SP	HSU-4SP	HSU-6SP	HSU-8SP
Volume of spillage	0.6	1.7	3.0	6.8	11.2

**Flow Rate – Pressure Loss Characteristics (Hydraulic oil / Water)**

[Test conditions] - Fluid : Hydraulic oil - Temperature : 30°C to 32°C  
- Fluid viscosity : 32×10<sup>-6</sup> m<sup>2</sup>/s - Density : 0.87×10<sup>3</sup> kg/m<sup>3</sup>

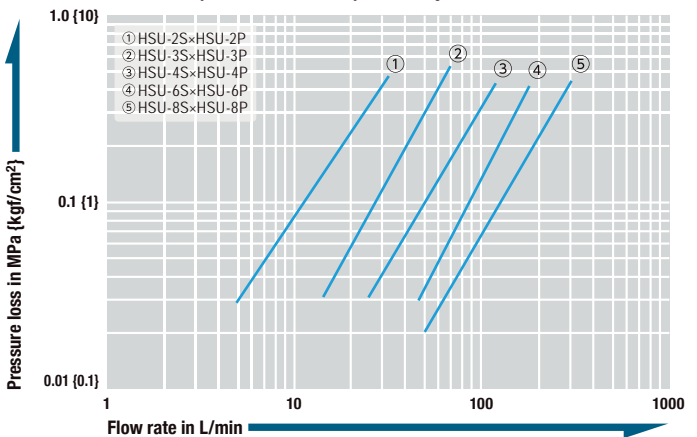

[Test conditions] - Fluid : Water - Temperature : 23°C±5°C

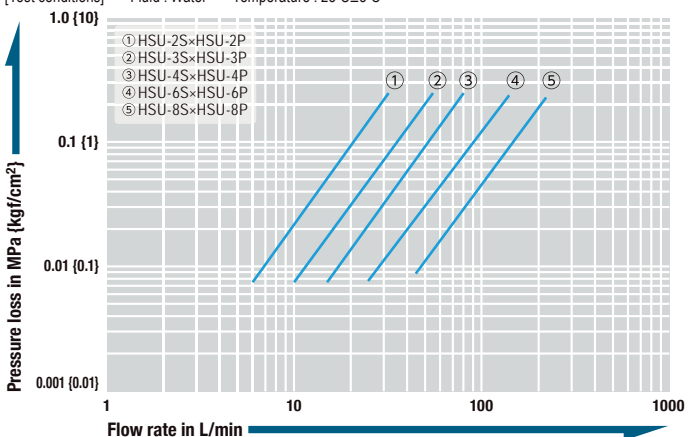



Models and Dimensions

Plug Female thread

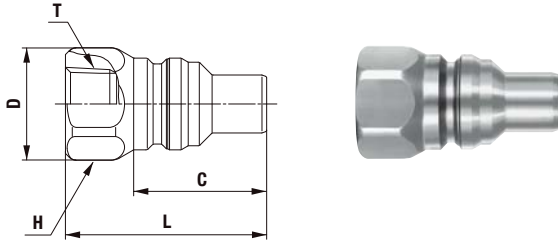

Model	Application (Thread)	Mass (g)	Dimensions (mm)				
			L	C	øD	H (WAF)	T
HSU-2P	R 1/4	49	45.5	27.5	21	Hex.19	Rc 1/4
HSU-3P	R 3/8	86	51.5	32	26.5	Hex.24	Rc 3/8
HSU-4P	R 1/2	152	59	39	33	Hex.30	Rc 1/2
HSU-6P	R 3/4	295	74	51.5	42	Hex.38	Rc 3/4
HSU-8P	R 1	481	83	58	51	Hex.46	Rc 1

Socket Female thread

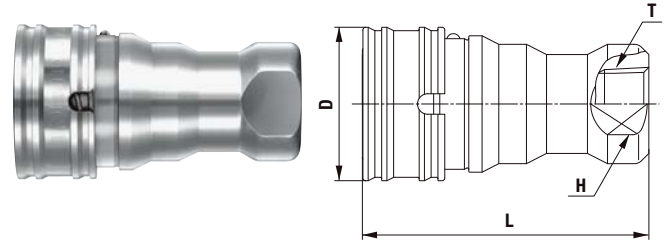

Model	Application (Thread)	Mass (g)	Dimensions (mm)			
			L	øD	H (WAF)	T
HSU-2S	R 1/4	142	63	28	19	Rc 1/4
HSU-3S	R 3/8	255	71.5	35	24	Rc 3/8
HSU-4S	R 1/2	479	84	45	30	Rc 1/2
HSU-6S	R 3/4	953	106	55	38	Rc 3/4
HSU-8S	R 1	1432	118	65	46	Rc 1

Separation Prevention Mechanism

Easy to operate separation prevention mechanism enhances operator safety.

**At connection**

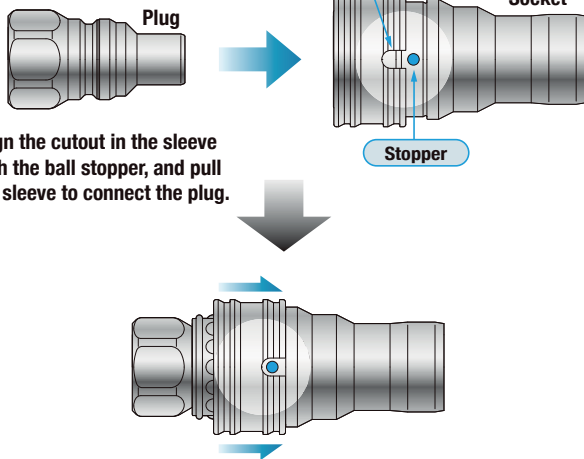

Align the cutout in the sleeve with the ball stopper, and pull the sleeve to connect the plug.



Separation prevention mechanism is easily locked by turning the sleeve after connection.

**Locking the sleeve**

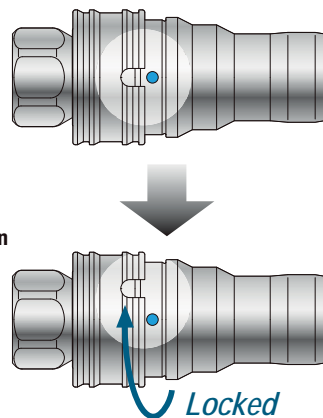

Without alignment of the cutout with the ball stopper disconnection cannot be made.

Accidental disconnection is prevented.

The stopper is marked with blue for visual understanding.

For High Pressure

# S210 CUPLA

Stainless steel CUPLA for high pressure up to 20.6 MPa {210 kgf/cm<sup>2</sup>}

<b>Working pressure</b>	<b>Valve structure</b>	<b>Applicable fluids</b>		
20.6 MPa (210 kgf/cm <sup>2</sup> )	Two-way shut-off	Water	Hydraulic oil	Gas

**Stainless steel for excellent corrosion resistance!**  
**The unique “inner seal mechanism” accepts a working pressure up to 20.6 MPa.**

- Body material is excellent corrosion resistant stainless steel (SUS304). Suited for use in tough conditions such as ocean development.
- Although it is made of stainless steel, the unique “inner seal mechanism” enables the working pressure of 20.6 MPa {210 kgf/cm<sup>2</sup>}, the same as special steel's.
- Separation prevention mechanism (safety lock) ensures tight and secured connection under vibration or impacts.
- Both socket and plug have built-in automatic shut-off valves that prevent fluid outflow on disconnection.

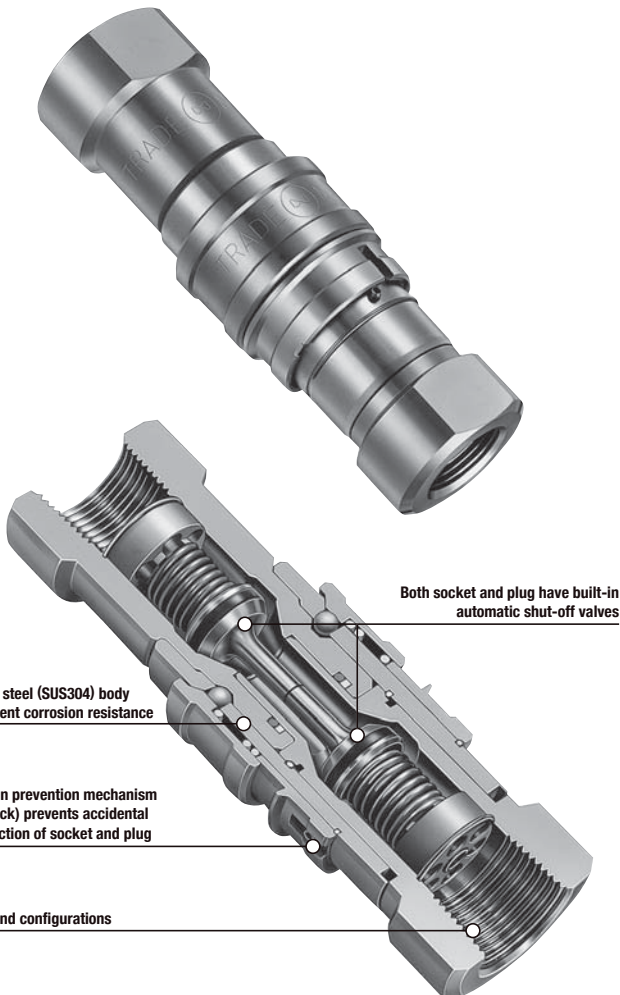

## Specifications

Body material	Stainless steel (SUS304)			
Size (Thread)	1/4", 3/8", 1/2", 3/4", 1"			
Pressure unit	MPa	kgf/cm <sup>2</sup>	bar	PSI
Working pressure	20.6	210	206	2990
Seal material Working temperature range <sup>*1</sup>	Seal material	Mark	Working temperature range	Remarks
	Fluoro rubber	FKM	-20°C to +180°C	Standard material
	Nitrile rubber	NBR	-20°C to +80°C	Made-to-order item

- The products come with dustproof caps.

\*1: The operable temperature range depends on the operating conditions.

## Maximum Tightening Torque Nm {kgf·cm}

Size (Thread)	1/4"	3/8"	1/2"	3/4"	1"
Torque	28 {286}	35 {357}	70 {714}	100 {1020}	180 {1836}

## Flow Direction

Fluid flow can be bi-directional when socket and plug are connected.



## Interchangeability

Socket and plug of different sizes cannot be connected.

## Minimum Cross-Sectional Area (mm<sup>2</sup>)

Model	S210-2SP	S210-3SP	S210-4SP	S210-6SP	S210-8SP
Minimum cross-sectional area	24	47	84	153	233

## Suitability for Vacuum 1.3 Pa {1×10<sup>-2</sup> mmHg}

Socket only	Plug only	When connected
-	-	Operational

## Admixture of Air on Connection May vary depending upon the usage conditions. (mL)

Model	S210-2SP	S210-3SP	S210-4SP	S210-6SP	S210-8SP
Volume of air	0.8	1.6	3.2	6.3	14.3

## Flow Rate – Pressure Loss Characteristics

[Test conditions] - Fluid : Hydraulic oil - Temperature : 30°C±5°C  
 - Fluid viscosity : 32×10<sup>-4</sup> m<sup>2</sup>/s - Density : 0.87×10<sup>3</sup> kg/m<sup>3</sup>

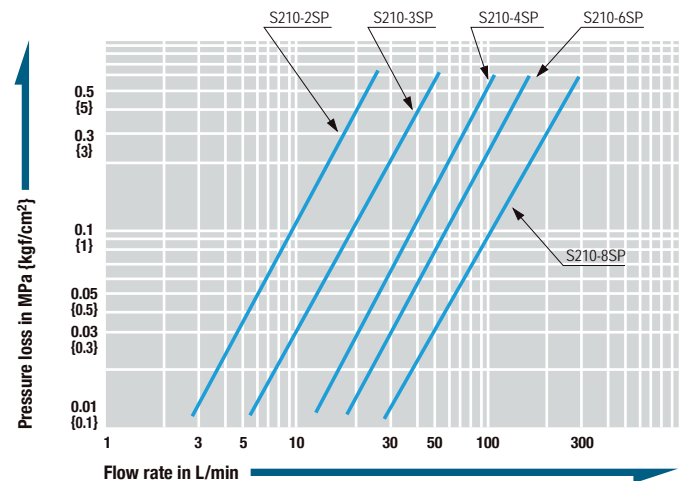

Models and Dimensions

**Plug Female thread**

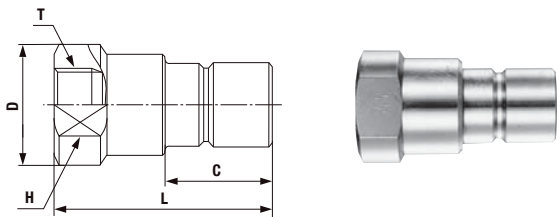

Model	Application (Thread)	Mass (g)	Dimensions (mm)				
			L	C	øD	H(WAF)	T
S210-2P	R 1/4	74	50.5	20	22	19	Rc 1/4
S210-3P	R 3/8	127	59	24	28	24	Rc 3/8
S210-4P	R 1/2	239	70.5	28	35	30	Rc 1/2
S210-6P	R 3/4	446	81.5	35.5	44	38	Rc 3/4
S210-8P	R 1	939	100	47.5	58	50	Rc 1

**Socket Female thread**

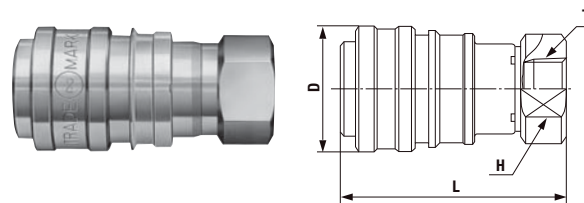

Model	Application (Thread)	Mass (g)	Dimensions (mm)			
			L	øD	H(WAF)	T
S210-2S	R 1/4	137	(59)	27	19	Rc 1/4
S210-3S	R 3/8	226	(68.5)	32	24	Rc 3/8
S210-4S	R 1/2	406	(81)	39.7	30	Rc 1/2
S210-6S	R 3/4	710	(97.5)	48	38	Rc 3/4
S210-8S	R 1	1381	(118)	62	50	Rc 1

How to operate the separation prevention mechanism (safety lock)

**How to lock**

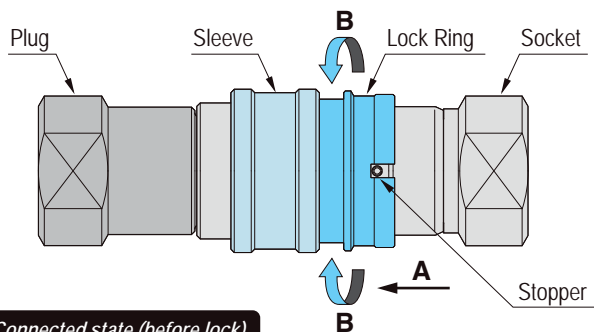

Connected state (before lock)

Slide the Lock Ring in the direction of the arrow A and rotate it in either direction simultaneously. When the Stopper is aligned with the shallow cutout on the Lock Ring, it will be locked.

**How to unlock**

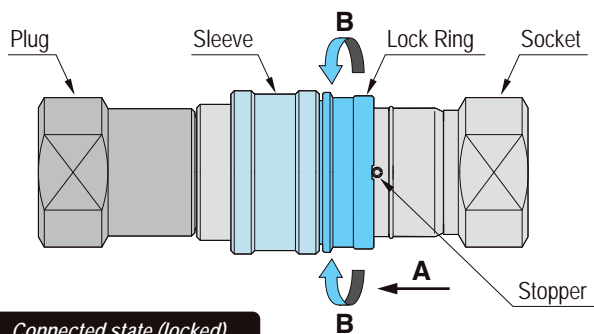

Connected state (locked)

Slide the Lock Ring in the direction of the arrow A and rotate it in either direction simultaneously. When the Stopper is aligned with the deeper cutout on the Lock Ring, it will be unlocked.

Application Example

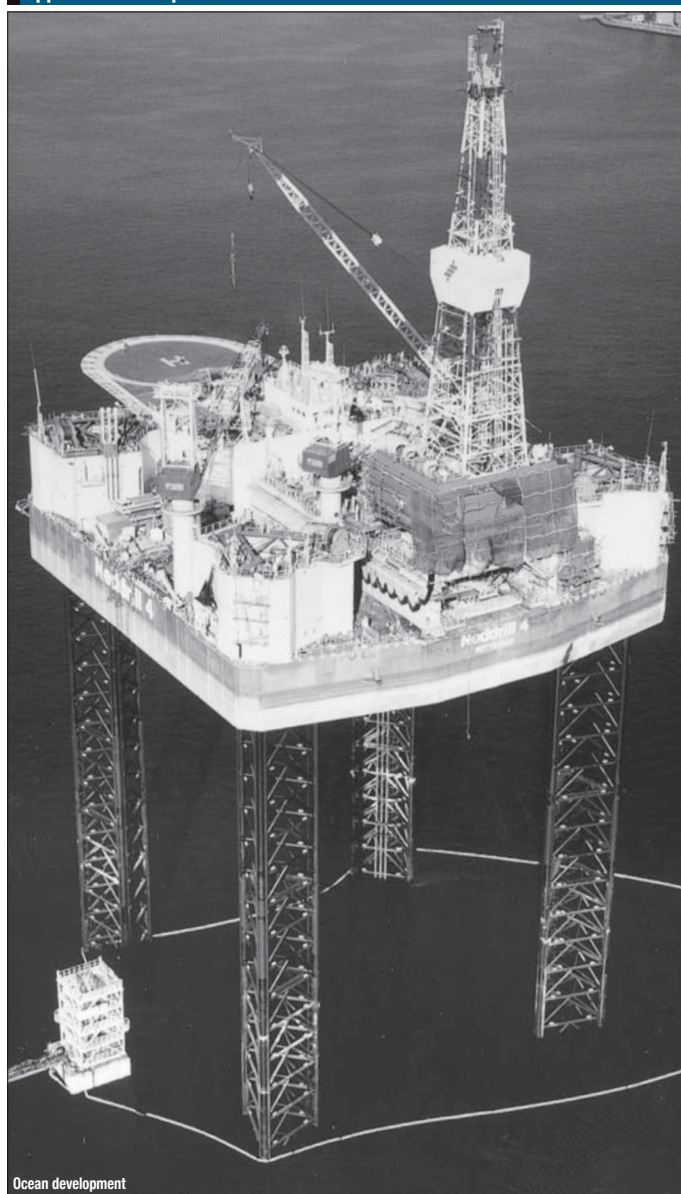

For High Pressure

# 280 CUPLA

For hydraulic pressure up to 27.5 to 31.5 MPa {281 to 321 kgf/cm<sup>2</sup>}

Working pressure



27.5 to 31.5 MPa  
(281 to 321 kgf/cm<sup>2</sup>)

Valve structure



Two-way shut-off

Applicable fluid



Hydraulic oil

**Copes with higher pressure lines in hydraulic equipment!  
Low pressure loss is ideal for hydraulic equipment.**

- Conforms to international standard ISO 7241-1A.
- Hydraulic CUPLA with the working pressure up to 27.5 to 31.5 MPa {281 to 321 kgf/cm<sup>2</sup>}.
- Structure keeps pressure loss extremely low, particularly ideal for hydraulic applications requiring high flow rates.
- Both socket and plug have built-in automatic shut-off valves to prevent fluid spill out when disconnected.
- Special steel body material is adopted for its excellent strength and additional quenching treatment is done to withstand hydro pressure impacts.



Specifications				
Body material	Special steel (Bright chromate conversion coating : silver color)			
Size (Thread)	1/4", 3/8"		1/2", 3/4", 1"	
Working pressure	MPa	31.5	27.5	
	kgf/cm <sup>2</sup>	321	281	
	bar	315	275	
	PSI	4570	3990	
Seal material	Seal material	Mark	Working temperature range	Remarks
Working temperature range <sup>*1</sup>	Nitrile rubber	NBR	-20°C to +80°C	Standard material

\*1: The operable temperature range depends on the operating conditions.

Maximum Tightening Torque					Nm {kgf·cm}	
Size (Thread)	1/4"	3/8"	1/2"	3/4"	1"	
Torque	28 {286}	40 {408}	80 {816}	100 {1020}	180 {1836}	

**Flow Direction**

Fluid flow can be bi-directional when socket and plug are connected.

**Interchangeability**

Socket and plug of different sizes cannot be connected. Can be connected with products whose mating part dimensions are in compliance with ISO7241-1A.

Minimum Cross-Sectional Area (mm <sup>2</sup> )					
Model	280-2SP	280-3SP	280-4SP	280-6SP	280-8SP
Minimum cross-sectional area	11.4	42.8	79.1	146.5	235.6

Suitability for Vacuum 1.3 Pa {1×10 <sup>-2</sup> mmHg}		
Socket only	Plug only	When connected
—	—	Operational

Admixture of Air on Connection May vary depending upon the usage conditions. (mL)					
Model	280-2SP	280-3SP	280-4SP	280-6SP	280-8SP
Volume of air	0.37	1.02	2.63	8.83	16.04

**Flow Rate – Pressure Loss Characteristics**

[Test conditions] - Fluid : Hydraulic oil - Temperature : 30°C±5°C  
- Fluid viscosity : 32×10<sup>-6</sup> m<sup>2</sup>/s - Density : 0.87×10<sup>3</sup> kg/m<sup>3</sup>

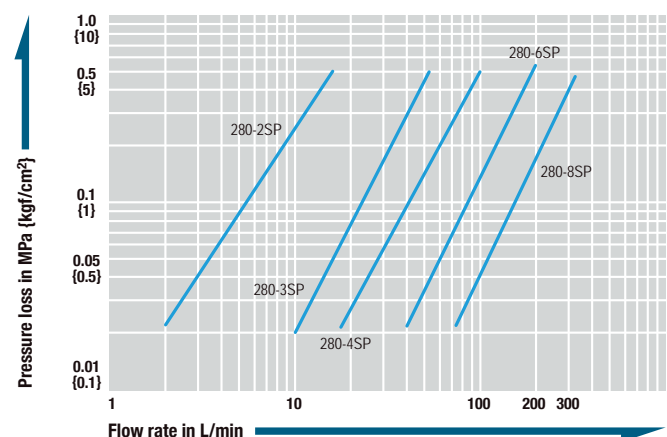

**⚠ Precautions for use**

There is no interchangeability between 280 CUPLA and HSP CUPLA, 210 CUPLA or 450B CUPLA. Do not connect each other even if some sizes are approximate.



Models and Dimensions

**Plug Female thread**

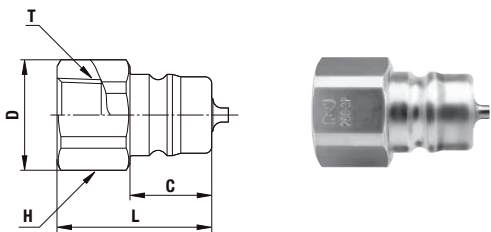

Model	Application (Thread)	Mass (g)	Dimensions (mm)				
			L	øD	C	H(WAF)	T
280-2P	R 1/4	35	31.5	20.5	15	Hex.19	Rc 1/4
280-3P	R 3/8	59	35	25	18.5	Hex.23	Rc 3/8
280-4P	R 1/2	115	44	32	24.5	Hex.29	Rc 1/2
280-6P	R 3/4	178	52.5	35	28	Hex.32	Rc 3/4
280-8P	R 1	331	63.5	44	35	41	Rc 1

\* Internal structural design of 280-6S and 280-8S is partly different from the above drawing.

**Socket Female thread**

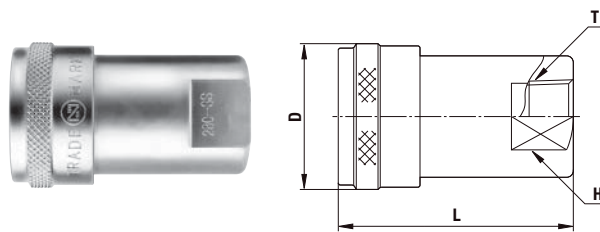

Model	Application (Thread)	Mass (g)	Dimensions (mm)			
			L	øD	H(WAF)	T
280-2S	R 1/4	110	(46)	(27)	19	Rc 1/4
280-3S	R 3/8	185	(53)	(33)	23	Rc 3/8
280-4S	R 1/2	335	66.5	(39)	29	Rc 1/2
280-6S	R 3/4	571	(81)	(48)	35	Rc 3/4
280-8S	R 1	871	98	(55)	41	Rc 1

**Application Example**

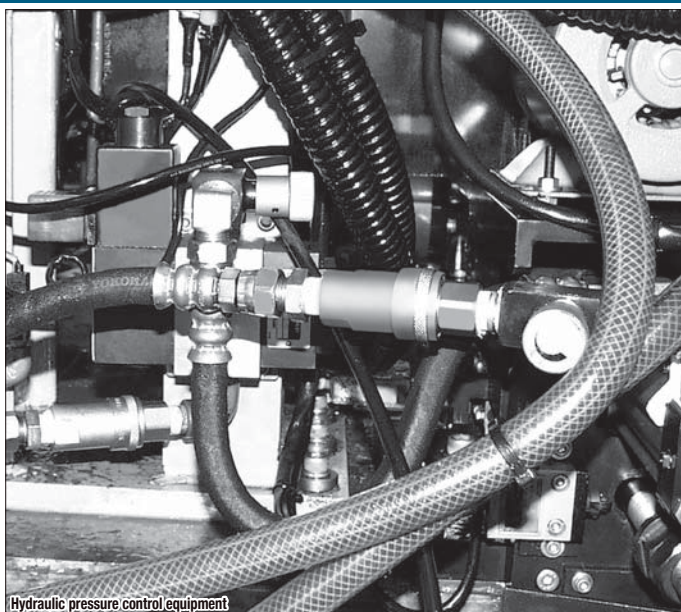
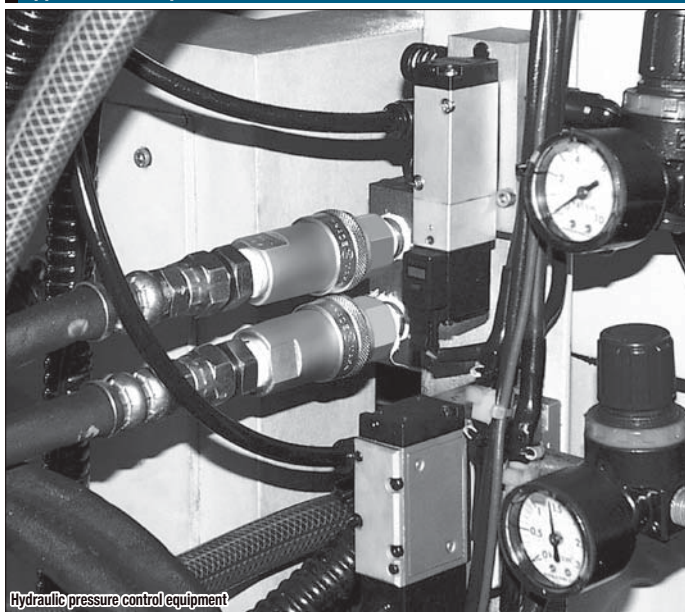





For High Pressure

# 350 CUPLA

For hydraulic pressures up to 34.5 MPa {352 kgf/cm<sup>2</sup>}

Working pressure	Valve structure	Applicable fluid
 34.5 MPa {352 kgf/cm <sup>2</sup> }	 Two-way shut-off (Spill Reduction)	 Hydraulic oil

Their “airless valve shut-off design” greatly reduces air admixture! For hydraulic lines with large pressure fluctuations.

- Body is made of special steel for durability. The body material is quenched to cope especially with impulses.
- Separation prevention mechanism is easily locked by turning the sleeve after connection.
- Both socket and plug have built-in automatic shut-off valves to prevent fluid spill out when disconnected.
- Push-to-connect operation.



## Specifications

Body material	Special steel (Nickel plated)			
Size (Thread)	1/4", 3/8", 1/2", 3/4", 1", 1 1/4", 1 1/2"			
Pressure unit	MPa	kgf/cm <sup>2</sup>	bar	PSI
Working pressure	34.5	352	345	5000
Seal material	Seal material	Mark	Working temperature range	Remarks
Working temperature range *1	Fluoro rubber	FKM	-20°C to +180°C	Standard material

\*1: The operable temperature range depends on the operating conditions.

## Maximum Tightening Torque

Size (Thread)	Nm {kgf·cm}						
	1/4"	3/8"	1/2"	3/4"	1"	1 1/4"	1 1/2"
Torque	28 {286}	40 {408}	80 {816}	150 {1530}	250 {2550}	500 {5100}	500 {5100}

## Flow Direction

Fluid flow can be bi-directional when socket and plug are connected.



## Interchangeability

Socket and plug of different sizes cannot be connected. However, 350-2SP with 350-3SP or 350-10SP with 350-12SP can be connected with each other.

## Minimum Cross-Sectional Area

Model	350-2SP	350-3SP	350-4SP	350-6SP	350-8SP	350-10SP	350-12SP
Minimum cross-sectional area	34.2	34.2	73.0	149.6	227.0	452.4	452.4

## Suitability for Vacuum

Not suitable for vacuum application in either connected or disconnected condition.

## Admixture of Air on Connection

Model	350-2SP	350-3SP	350-4SP	350-6SP	350-8SP	350-10SP	350-12SP
Volume of air	0.1	0.1	0.2	0.3	0.5	0.9	0.9

## Flow Rate – Pressure Loss Characteristics

[Test conditions] - Fluid : Hydraulic oil - Temperature : 40°C±5°C  
- Fluid viscosity : 32×10<sup>-6</sup> m<sup>2</sup>/s - Density : 0.87×10<sup>3</sup> kg/m<sup>3</sup>

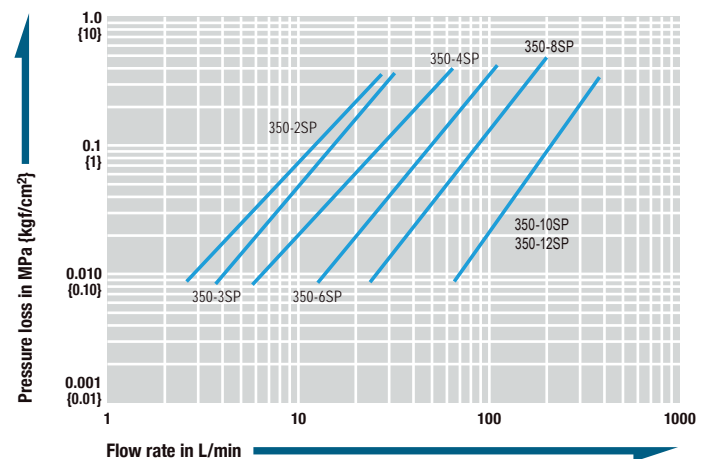

## ⚠ Precautions for use

Do not connect / disconnect CUPLA when pressure is applied or remaining.

Models and Dimensions

**Plug Female thread**

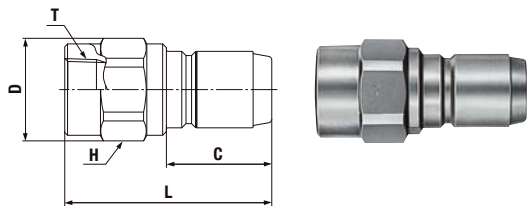

\*The above picture and external dimensions are the appearance of 350-8P. Product appearance may vary by size.

Model	Application (Thread)	Mass (g)	Dimensions (mm)				
			L	C	øD	H(WAF)	T
350-2P	R 1/4	170	(72)	36	29	Hex.27	Rc 1/4
350-3P	R 3/8	167	(72)	36	29	Hex.27	Rc 3/8
350-4P	R 1/2	245	85	40.5	30	Hex.27	Rc 1/2
350-6P	R 3/4	415	87	44.5	40	Hex.36	Rc 3/4
350-8P	R 1	950	111	56.5	55	Hex.50	Rc 1
350-10P	R 1 1/4	2700	(144)	75	78	Hex.70	Rc 1 1/4
350-12P	R 1 1/2	2600	(144)	75	78	Hex.70	Rc 1 1/2

- G thread is available on request.

**Socket Female thread**

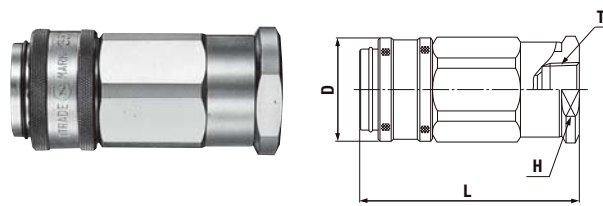

Model	Application (Thread)	Mass (g)	Dimensions (mm)			
			L	øD	H(WAF)	T
350-2S	R 1/4	360	(82)	(34)	Hex.30	Rc 1/4
350-3S	R 3/8	353	(82)	(34)	Hex.30	Rc 3/8
350-4S	R 1/2	545	(93.5)	(41)	Hex.36	Rc 1/2
350-6S	R 3/4	976	(105.5)	(49)	46×ø52	Rc 3/4
350-8S	R 1	1740	(129)	(63)	55×ø62	Rc 1
350-10S	R 1 1/4	5600	(180)	89	Hex.80×ø90	Rc 1 1/4
350-12S	R 1 1/2	5500	(180)	89	Hex.80×ø90	Rc 1 1/2

- G thread is available on request.

Application Example

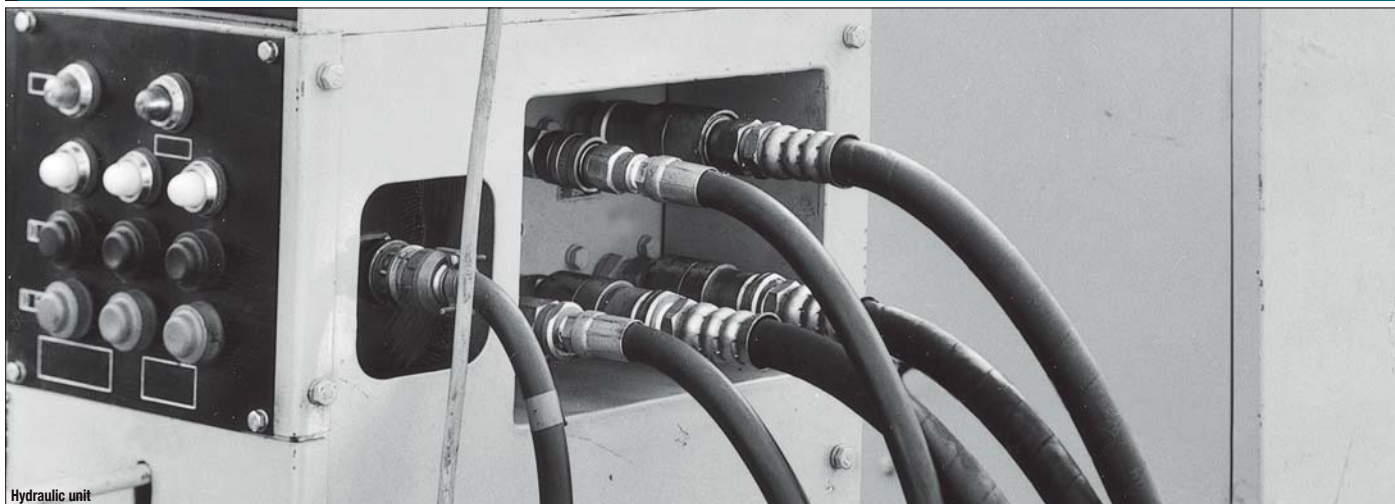

Optional Accessory

# PURGE ADAPTER

## Residual Pressure Purge Adapter for Hydraulic Lines

• Can be attached to hydraulic lines to purge residual pressure effectively.

See page 169 for the details.

Specifications

Model	PAD-2	PAD-3FM	PAD-4FM	PAD-6FM	PAD-8FM
Body material	Steel (Nickel plated)				
Application (Thread)	R 1/4	R 3/8 × Rc 3/8	R 1/2 × Rc 1/2	R 3/4 × Rc 3/4	R 1 × Rc 1
Pressure unit	MPa	kgf/cm <sup>2</sup>	bar	PSI	
Working pressure	35.0	357	350	5080	
Drain outlet port	For 8 mm OD tube	Application: Rc 1/8 (Max. Tightening Torque: 5 Nm)			
Applicable fluids	Hydraulic oil				
Seal material	Seal material	Mark	Working temperature range	Remarks	
Working temperature range *1	Nitrile rubber	NBR	-5°C to +80°C	Standard material	

\*1: The operable temperature range depends on the operating conditions.

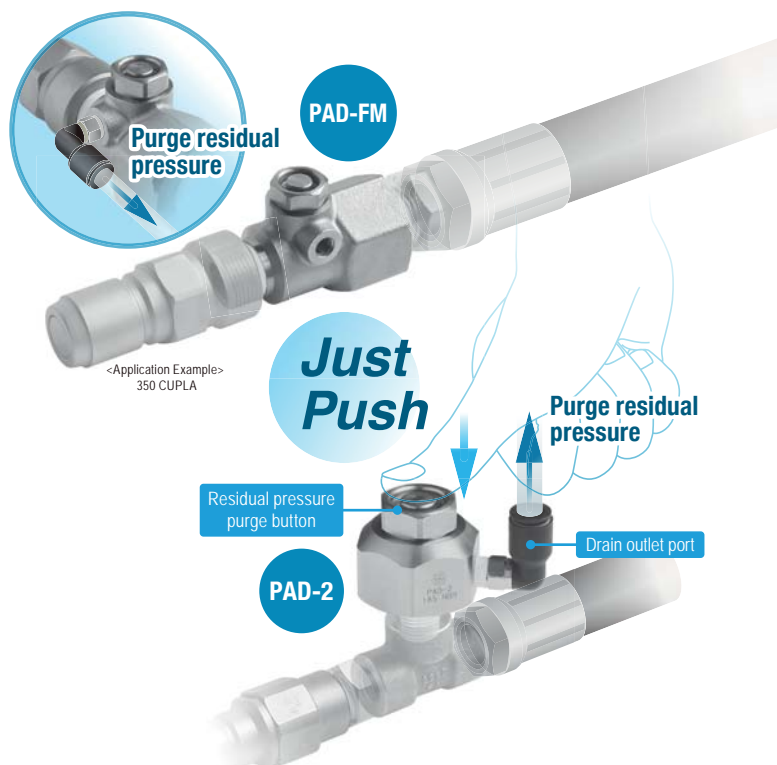

For High Pressure

# FLATFACE CUPLA F35

For hydraulic pressures up to 35.0 MPa {357 kgf/cm<sup>2</sup>} with flat contact face

Working pressure <b>35.0</b> 35.0 MPa (357 kgf/cm <sup>2</sup> )	Valve structure  Two-way shut-off (Spill Reduction)	Applicable fluid  Hydraulic oil
---	--	---------------------------------------

## Flat contact face design reduces spill upon disconnection.

- Flat contact face design makes it easy to clean dust and foreign matter adhered on the surface of coupling so as to prevent them from entering inside and thus causing faulty operation of connection or disconnection.
- Flat contact face design minimizes air admixture during connection to keep the possible malfunction of equipment caused by the air bubbles in the hydraulic line at minimum level.
- Push-to-connect operation.
- Separation prevention mechanism is easily locked by turning the sleeve after connection. It prevents accidental disconnection even when vibration or impact is applied to CUPLA.
- The special design reduces pressure loss considerably, and especially suited to hydraulic applications in which big flow is needed. Both socket and plug have built-in automatic shut-off valves that prevent fluid spill out on disconnection.

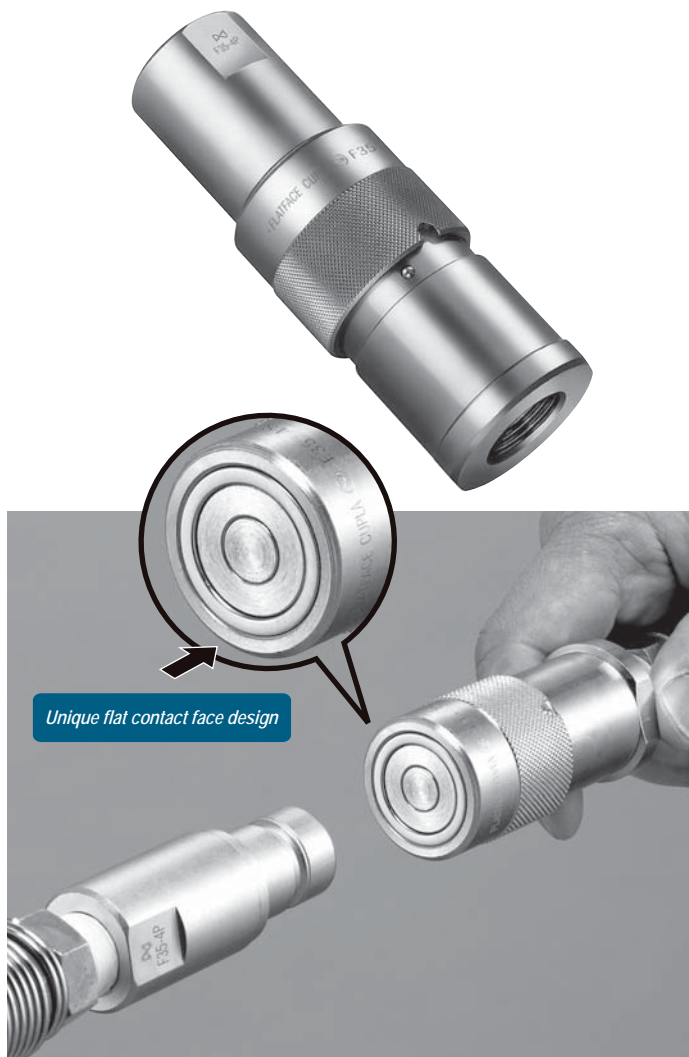

### Specifications

Body material	Special steel (Nickel plated)			
Size (Thread)	1/4", 3/8", 1/2", 3/4", 1"			
Pressure unit	MPa	kgf/cm <sup>2</sup>	bar	PSI
Working pressure	35.0	357	350	5080
Seal material	Seal material	Mark	Working temperature range	Remarks
Working temperature range *1	Fluoro rubber	FKM	-20°C to +180°C	Standard material

\*1: The operable temperature range depends on the operating conditions.

### Maximum Tightening Torque Nm {kgf·cm}

Size (Thread)	1/4"	3/8"	1/2"	3/4"	1"
Torque	28 (286)	40 (408)	80 (816)	150 (1530)	250 (2550)

### Flow Direction

Fluid flow can be bi-directional when socket and plug are connected.



### Interchangeability

Socket and plug of different sizes cannot be connected.

### Minimum Cross-Sectional Area (mm<sup>2</sup>)

Model	F35-2SP	F35-3SP	F35-4SP	F35-6SP	F35-8SP
Minimum cross-sectional area	21.2	32.2	78.5	149.6	227.0

### Suitability for Vacuum

Not suitable for vacuum application in either connected or disconnected condition.

### Admixture of Air on Connection (mL) May vary depending upon the usage conditions.

Model	F35-2SP	F35-3SP	F35-4SP	F35-6SP	F35-8SP
Volume of air	0.1	0.1	0.2	0.3	0.4

### Flow Rate – Pressure Loss Characteristics

[Test conditions] - Fluid : Hydraulic oil - Temperature : 30°C±5°C  
- Fluid viscosity : 32×10<sup>-6</sup> m<sup>2</sup>/s - Density : 0.87×10<sup>3</sup> kg/m<sup>3</sup>

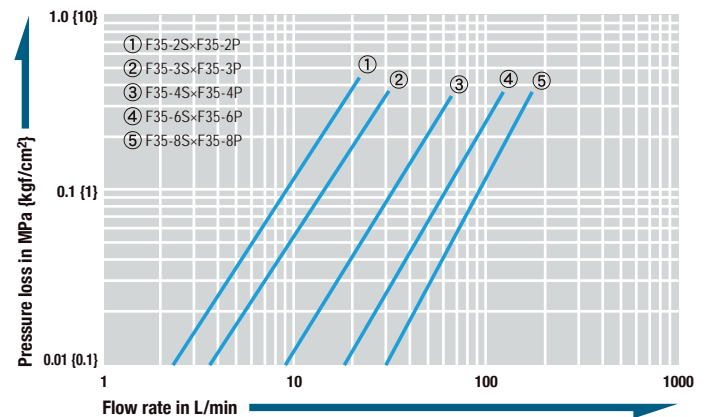

### ⚠ Precautions for use

Do not connect / disconnect CUPLA when pressure is applied or remaining.



Models and Dimensions

**Plug** Female thread

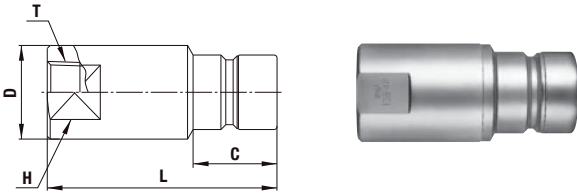

Model	Application (Thread)	Mass (g)	Dimensions (mm)				
			L	C	øD	H(WAF)	T
F35-2P	R 1/4	106	58	18.8	21.5	19	Rc 1/4
F35-3P	R 3/8	190	67.5	24	27	24	Rc 3/8
F35-4P	R 1/2	290	78	28.5	31.7	27	Rc 1/2
F35-6P	R 3/4	460	84.5	31	40	36	Rc 3/4
F35-8P	R 1	1000	108	39	50	46	Rc 1

**Socket** Female thread

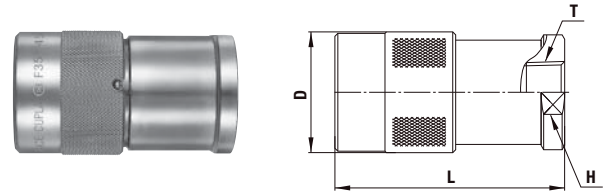

Model	Application (Thread)	Mass (g)	Dimensions (mm)			
			L	øD	H(WAF)	T
F35-2S	R 1/4	182	(57.5)	(28)	26×ø28.5	Rc 1/4
F35-3S	R 3/8	320	(70)	(34)	30	Rc 3/8
F35-4S	R 1/2	490	(78)	(41)	36	Rc 1/2
F35-6S	R 3/4	815	(85)	(49)	46×ø50	Rc 3/4
F35-8S	R 1	1520	(104)	(63)	55	Rc 1

Application Example



Snow plow



For High Pressure

# FLATFACE CUPLA FF

For hydraulic pressure up to 35.0 MPa {357 kgf/cm<sup>2</sup>} with flat contact face

Working pressure <b>35.0</b> 35.0 MPa {357 kgf/cm <sup>2</sup> }	Valve structure  Two-way shut-off (Spill Reduction)	Applicable fluid  Hydraulic oil
---	--	---------------------------------------

Compared with 350 CUPLA and FLATFACE CUPLA F35, the flow volume is increased 1.5 to 2 times.

\*Increase ratio of each flow volume depends on the CUPLA product size.

- "Airless valve shut-off" design minimizes spillage volume on disconnection and admixture volume of air on connection.
- Suitable for hydraulic lines with drastic high pressure pulsation such as in die-casting machines.
- Separation prevention mechanism preventing accidental disconnection under vibration or impacts enhances workability and safety.
- Sizes are Rc 3/8, Rc 1/2, Rc 3/4, and Rc 1.

\*Only the same size of socket and plug can be connected.



Offset concave flat face enables quick and smooth connection

## Unique flat face design

Concaved offset for the flat face on socket guides plug for quick and smooth centering and connection, but still easy to wipe off dirt and dusts.

Hexagon nut for easy mount



## Specifications

Body material	Special steel (Nickel plated)			
Size (Thread)	3/8", 1/2", 3/4", 1"			
Pressure unit	MPa	kgf/cm <sup>2</sup>	bar	PSI
Working pressure	35.0	357	350	5080
Seal material	Seal material	Mark	Working temperature range	Remarks
Working temperature range *1	Nitrile rubber	NBR	-20°C to +80°C	Standard material

\*1: The operable temperature range depends on the operating conditions.

## Maximum Tightening Torque

Nm {kgf·cm}

Size (Thread)	3/8"	1/2"	3/4"	1"
Torque	40 {408}	80 {816}	150 {1530}	250 {2550}

## Flow Direction

Fluid flow can be bi-directional when socket and plug are connected.



## Interchangeability

Socket and plug of different sizes cannot be connected.

## Minimum Cross-Sectional Area

(mm<sup>2</sup>)

Model	FF-3S×FF-3P	FF-4S×FF-4P	FF-6S×FF-6P	FF-8S×FF-8P
Minimum cross-sectional area	51	106	215	332

## Suitability for Vacuum

Not suitable for vacuum application in either connected or disconnected condition.

## Admixture of Air on Connection

May vary depending upon the usage conditions.

(mL)

Model	FF-3S×FF-3P	FF-4S×FF-4P	FF-6S×FF-6P	FF-8S×FF-8P
Volume of air admixture	0.018	0.029	0.033	0.080

## Volume of Spillage per Disconnection

May vary depending upon the usage conditions.

(mL)

Model	FF-3S×FF-3P	FF-4S×FF-4P	FF-6S×FF-6P	FF-8S×FF-8P
Volume of spillage	0.009	0.023	0.031	0.110

## Flow Rate – Pressure Loss Characteristics

[Test conditions] - Fluid : Hydraulic oil - Temperature : 30°C±5°C  
- Fluid viscosity : 32×10<sup>-6</sup> m<sup>2</sup>/s - Density : 0.87×10<sup>3</sup> kg/m<sup>3</sup>

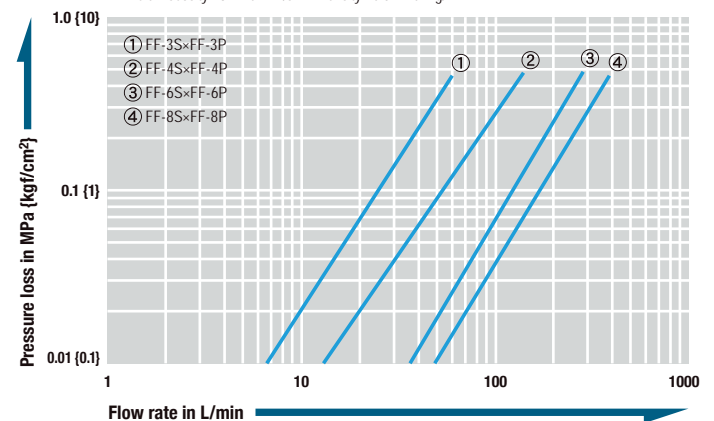

## ⚠ Precautions for use

Do not connect / disconnect CUPLA when pressure is applied or remaining.

Models and Dimensions

**Plug Female thread**

Model	Application (Thread)	Mass (g)	Dimensions (mm)				
			L	øD	A	H (WAF)	T
FF-3P	R 3/8	252	(66)	34	20.5	Hex.29	Rc 3/8
FF-4P	R 1/2	409	(74)	42	22.8	Hex.32	Rc 1/2
FF-6P	R 3/4	709	(82.5)	54	27	Hex.41	Rc 3/4
FF-8P	R 1	1314	(96.5)	66	29.5	Hex.54	Rc 1

**Socket Female thread**

Model	Application (Thread)	Mass (g)	Dimensions (mm)			
			L	øD	H (WAF)	T
FF-3S	R 3/8	345	(71)	(35.5)	Hex.29	Rc 3/8
FF-4S	R 1/2	608	(84)	(44)	Hex.32	Rc 1/2
FF-6S	R 3/4	1053	(95)	(54)	Hex.41	Rc 3/4
FF-8S	R 1	1865	(109.5)	(66)	Hex.54	Rc 1

Applications

- Hydraulic piping for die-casting machines
- Casting machines
- Electric furnaces
- Molding presses
- Forging press
- Powdery alloy presses
- Extrusion molding machines
- Machine tools
- Iron manufacturing blast furnaces
- Continuous casting machines
- Rolling mills
- Pipe forging machines
- Furnace opening / closing machines
- Glass molding machines, etc.

**Built-in automatic shut-off valve**

**Separation prevention mechanism**

**Unique flat face design**

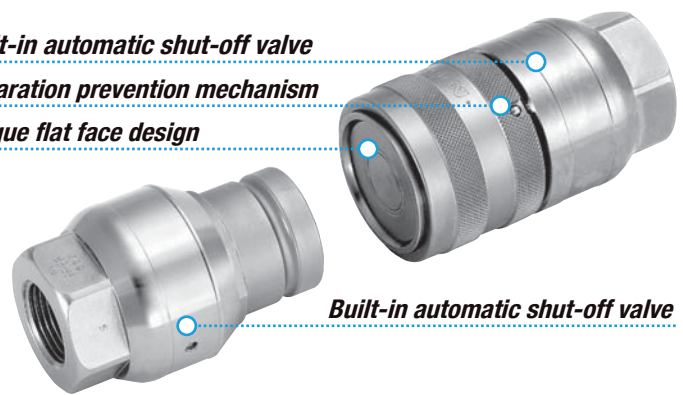

**Built-in automatic shut-off valve**

For High Pressure

# 450B CUPLA

For hydraulic pressure up to 44.1 MPa {450 kgf/cm<sup>2</sup>}

Working pressure



Valve structure



Applicable fluid



**Metal-touch valve system with superior durability!**  
**Separation prevention mechanism gives secure connection.**

- CUPLA for higher working pressure up to 44.1 MPa {450 kgf/cm<sup>2</sup>}.
- Separation prevention mechanism is easily locked by turning the sleeve after connection.
- Both socket and plug have metal-touch automatic shut-off valves that prevent fluid spill out on disconnection.

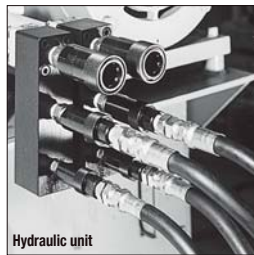

Hydraulic unit

Specifications				
Body material	Special steel (Nickel plated)			
Size (Thread)	3/8"			
Pressure unit	MPa	kgf/cm <sup>2</sup>	bar	PSI
Working pressure	44.1	450	441	6400
Seal material	Seal material	Mark	Working temperature range	Remarks
	Nitrile rubber	NBR	-20°C to +80°C	Standard material
Working temperature range <sup>*1</sup>	Fluoro rubber	FKM	-20°C to +180°C	Made-to-order item
	Stand-alone leakage rate on either socket or plug			
0.1 mL/min at 0.3 MPa (3 kgf/cm <sup>2</sup> )				

\*1: The operable temperature range depends on the operating conditions.

Maximum Tightening Torque	Nm {kgf·cm}
Torque	40 (408)

**Flow Direction**

Fluid flow can be bi-directional when socket and plug are connected.

Minimum Cross-Sectional Area	(mm <sup>2</sup> )
Minimum cross-sectional area	37

Suitability for Vacuum			1.3 Pa {1×10 <sup>-2</sup> mmHg}
Socket only	Plug only	When connected	
-	-	Operational	

Admixture of Air on Connection	(mL)
Volume of air admixture	1.43

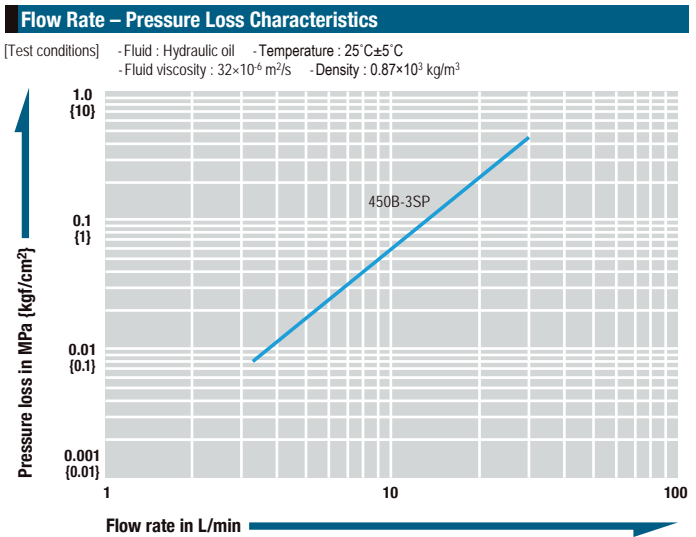

**⚠ Precautions for use**

There is no interchangeability between 450B CUPLA and HSP CUPLA, 210 CUPLA or 280 CUPLA. Do not connect each other even if some sizes are approximate.

**Models and Dimensions**

WAF : WAF stands for width across flats.

**Plug Female thread**

Model	Application (Thread)	Mass (g)	Dimensions (mm)				
			L	C	øD	H(WAF)	T
450B-3P	R 3/8	95	37.5	22.5	28	24	Rc 3/8

**Socket Female thread**

Model	Application (Thread)	Mass (g)	Dimensions (mm)			
			L	øD	H(WAF)	T
450B-3S	R 3/8	285	59.5	(36)	24	Rc 3/8

For High Pressure

# 700R CUPLA

For hydraulic pressure up to 68.6 MPa {700 kgf/cm<sup>2</sup>}

Working pressure



Valve structure



Applicable fluid



## High pressure CUPLA for working pressures up to 68.6 MPa.

- Metal-touch valves use no rubber seal, and thus ensure excellent durability.
- Both socket and plug have metal touch automatic shut-off valves that prevent fluid spill out on disconnection.



### Specifications

Body material	Special steel (Nickel plated)			
Size (Thread)	3/8", 1/2"			
Pressure unit	MPa	kgf/cm <sup>2</sup>	bar	PSI
Working pressure	68.6	700	686	9950
Seal material	Seal material	Mark	Working temperature range	Remarks
	Nitrile rubber	NBR	-20°C to +80°C	Standard material
Working temperature range <sup>1)</sup>	Fluoro rubber	FKM	-20°C to +180°C	Made-to-order item
	Stand-alone leakage rate on either socket or plug	For 700R-3SP, 0.05 mL/min at 0.2 MPa (2 kgf/cm <sup>2</sup> ) For 700R-4SP, 0.5 mL/min at 0.3 MPa (3 kgf/cm <sup>2</sup> )		

<sup>1)</sup> Do not use in an environment where there is impulse pressure.

<sup>1)</sup> The operable temperature range depends on the operating conditions.

### Maximum Tightening Torque

Nm {kgf·cm}

Size (Thread)	3/8"	1/2"
Torque	40 (408)	85 (867)

### Flow Direction

Fluid flow can be bi-directional when socket and plug are connected.

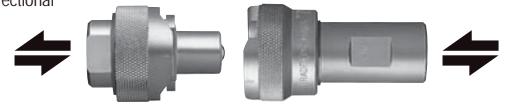

### Interchangeability

Socket and plug of different sizes cannot be connected.

### Minimum Cross-Sectional Area

(mm<sup>2</sup>)

Model	700R-3SP	700R-4SP
Minimum cross-sectional area	34	55

### Suitability for Vacuum

1.3 Pa {1×10<sup>-2</sup> mmHg}

Socket only	Plug only	When connected
-	-	Operational

### Admixture of Air on Connection

May vary depending upon the usage conditions.

(mL)

Model	700R-3SP	700R-4SP
Volume of air admixture	1.0	2.2

### Flow Rate – Pressure Loss Characteristics

[Test conditions] - Fluid : Hydraulic oil - Temperature : 30°C±5°C  
- Fluid viscosity : 32×10<sup>-6</sup> m<sup>2</sup>/s - Density : 0.87×10<sup>3</sup> kg/m<sup>3</sup>

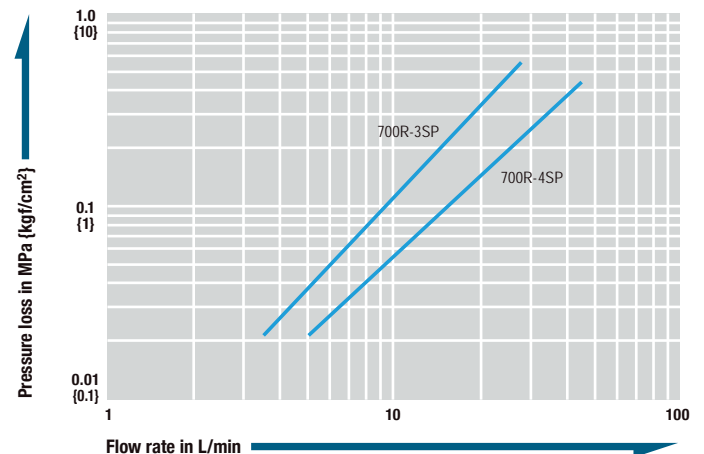

### Models and Dimensions

WAF : WAF stands for width across flats.

#### Plug

#### Female thread

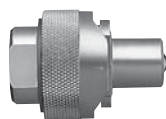
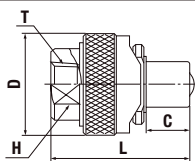

Model	Application (Thread)	Mass (g)	Dimensions (mm)				
			L	C	øD	H(WAF)	T
700R-3P	R 3/8	210	54	18	(39.5)	24	Rc 3/8
700R-4P	R 1/2	418	70	22	(50)	27	Rc 1/2

#### Socket

#### Female thread

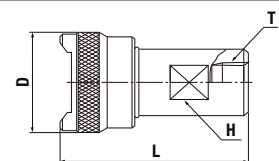

Model	Application (Thread)	Mass (g)	Dimensions (mm)			
			L	øD	H(WAF)	T
700R-3S	R 3/8	270	(73)	(39.5)	22	Rc 3/8
700R-4S	R 1/2	562	(91)	(50)	27	Rc 1/2



## For Multi-Port Connection (Manual)

# MULTI CUPLA MAM Type

### Multiple air port system

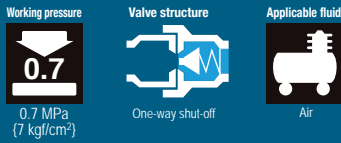

**Simultaneously connects several ports securely in one operation!  
Greatly cuts cycle time in multiple ports replacement.**

- Handles several ports at once.
- Simple action with lever enables easy connection/disconnection manually.
- Comes with lock mechanism to prevent accidental disconnection.
- Valve on socket side only.

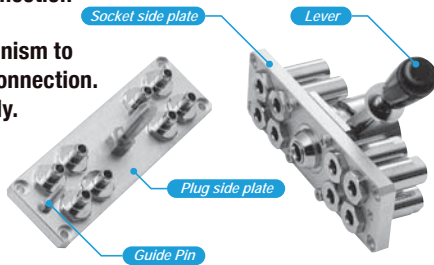

### Specifications

Body material	CUPLA : Brass (Chrome plated) Plate : Aluminum alloy (4, 8, 12 ports) / Plate : Steel (16 ports) Locking unit : Steel and others			
Size (Thread)	Rc 1/8			
Pressure unit	MPa	kgf/cm <sup>2</sup>	bar	PSI
Working pressure	0.7	7	7	102
Seal material	Seal material	Mark	Working temperature range	
Working temperature range *1	Nitrile rubber	NBR	-20°C to +60°C	

\*1: The operable temperature range depends on the operating conditions.

### Maximum Tightening Torque

Nm {kgf·cm}

Torque	5 {51}
--------	--------

### Interchangeability

No connection is possible between plates with different number of ports.

### Minimum Cross-Sectional Area

(mm<sup>2</sup>)

Per port	15.9
----------	------

### Suitability for Vacuum

Not suitable for vacuum application in either connected or disconnected condition.

### Pressure - Flow Characteristics

Per port with CUPLA

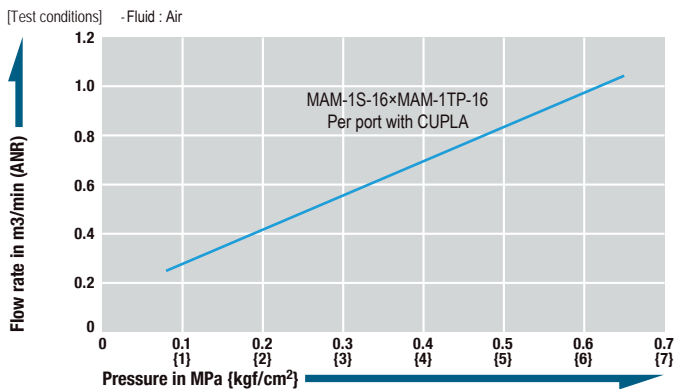

### Models and Dimensions

WAF : WAF stands for width across flats.

#### Model MAM-1TP-4xMAM-1S-4 (4 ports type)

Application (Thread): R 1/8 Mass: 150 g (Plug), 500 g (Socket)

#### Plate with CUPLA MAM Type

4  
Ports

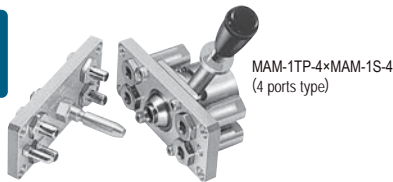

#### Plug: Model MAM-1TP-4

#### Socket: Model

#### MAM-1S-4

Dimensions (mm)

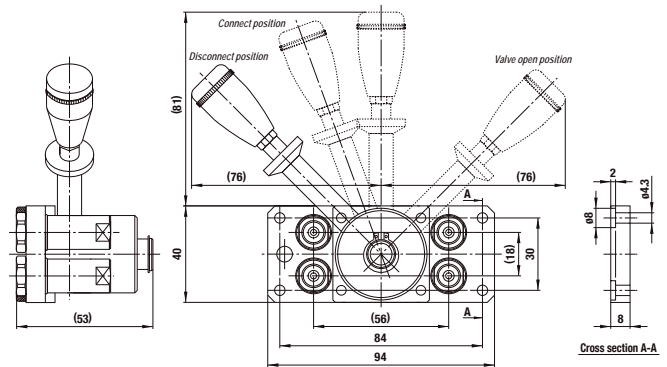
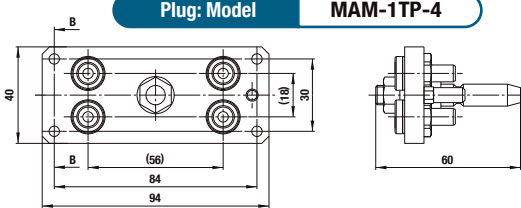
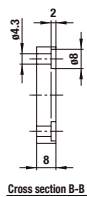

#### Model MAM-1TP-8xMAM-1S-8 (8 ports type)

Application (Thread): R 1/8 Mass: 250 g (Plug), 650 g (Socket)

#### Plate with CUPLA MAM Type

8  
Ports

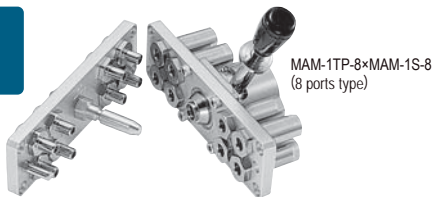

#### Plug: Model MAM-1TP-8

#### Socket: Model

#### MAM-1S-8

Dimensions (mm)

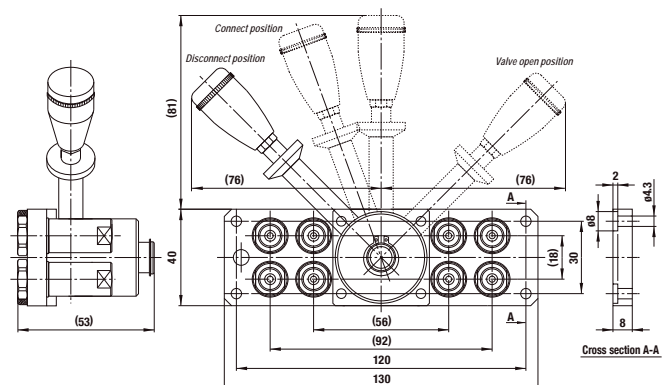
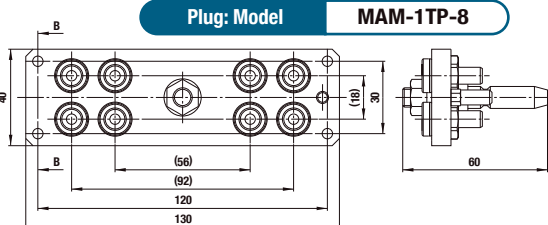
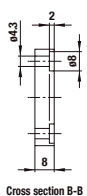

Models and Dimensions

Model MAM-1TP-12×MAM-1S-12 (12 ports type)

Application (Thread): R 1/8 Mass: 350 g (Plug), 800 g (Socket)

Dimensions (mm)

Plate with CUPLA  
MAM Type

12  
Ports

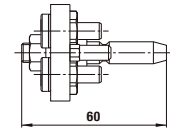
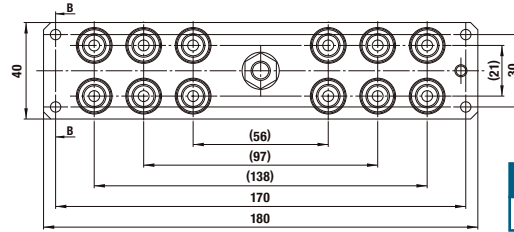
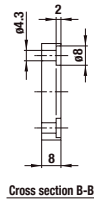

Plug: Model  
MAM-1TP-12

Socket: Model  
MAM-1S-12

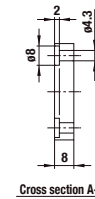
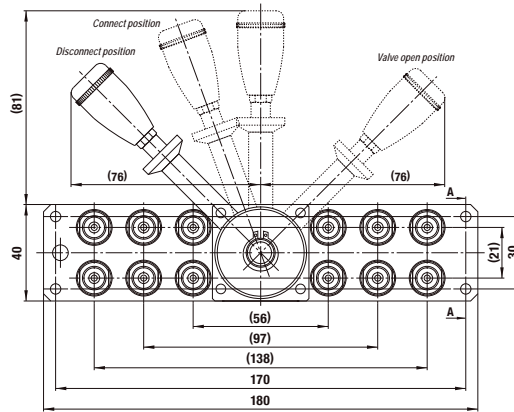
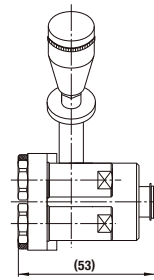

Model MAM-1TP-16×MAM-1S-16 (16 ports type)

Application (Thread): R 1/8 Mass: 680 g (Plug), 1180 g (Socket)

Dimensions (mm)

Plate with CUPLA  
MAM Type

16  
Ports

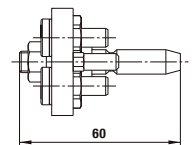
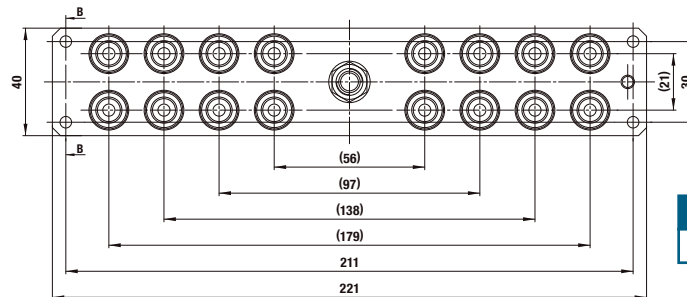
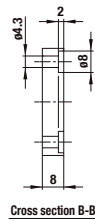
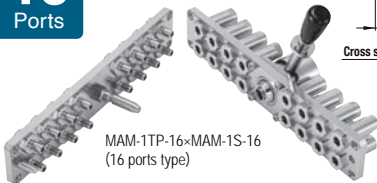

Plug: Model  
MAM-1TP-16

Socket: Model  
MAM-1S-16

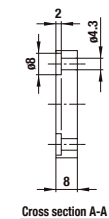
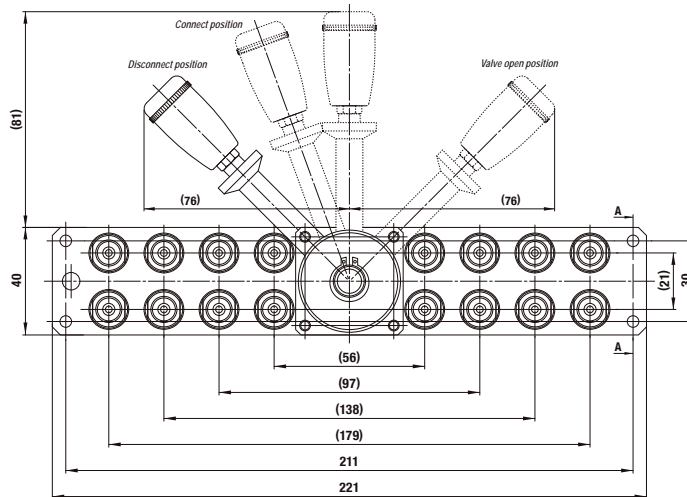
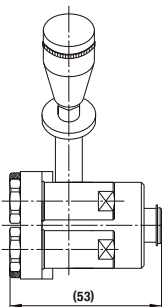

Plug Model MAS-1TP (Individual CUPLA)

- Application (Thread): R 1/8 Mass: 17 g
- Can be mounted on model MAM-1TP-4/MAM-1TP-8/MAM-1TP-12/MAM-1TP-16.

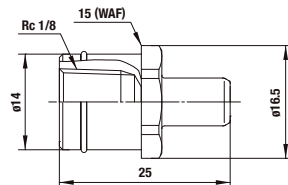

Dimensions (mm)

Socket Model MAS-1S (Individual CUPLA)

- Application (Thread): R 1/8 Mass: 33 g
- Can be mounted on model MAM-1S-4/MAM-1S-8/MAM-1S-12/MAM-1S-16.

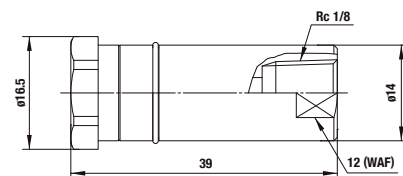

Dimensions (mm)

For Multi-Port Connection (Manual)

# MULTI CUPLA MAM-B Type

Multiple port system

Working pressure



Valve structure



Applicable fluids



Simultaneously connects several ports securely in one operation. Greatly reduces changeover time in multiple ports replacement.

- Handles several ports at once.
- Simple manual lever action completes easy connection/disconnection.
- Two-stage lever operation prevents CUPLA from accidental dropping due to sudden detachment.
- Comes with lock mechanism to prevent accidental disconnection.
- Large flow equivalent to that of SP CUPLA Type A.
- Two kinds of plates are available for each size.
- Automatic shut-off valves in both socket and plug prevent fluid spill out on disconnection.
- Self-aligned valve design provides safety sealing of individual socket or plug when disconnected.

MAM-B-2P6×MAM-B-2S6  
(6 ports type)

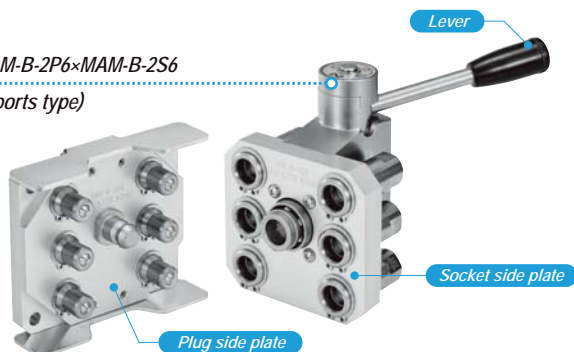

MAM-B-1P8×MAM-B-1S8  
(8 ports type)

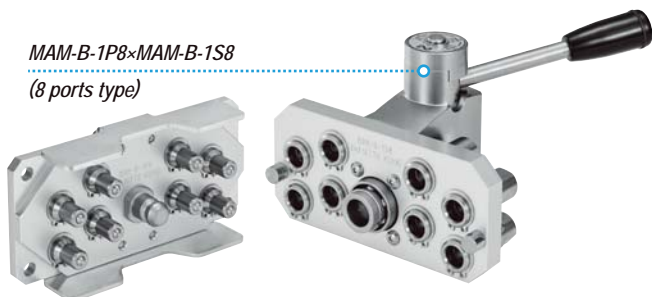

MAM-B-1P12×MAM-B-1S12  
(12 ports type)

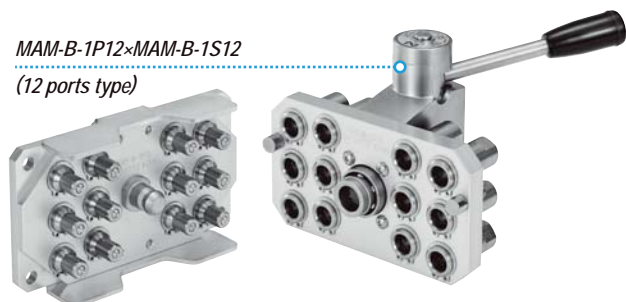

Specifications					
Model	Plug	MAM-B-1P8	MAM-B-1P12	MAM-B-2P6	MAM-B-2P8
	Socket	MAM-B-1S8	MAM-B-1S12	MAM-B-2S6	MAM-B-2S8
Number of ports	8		12	6	8
Size (Thread)	1/8"		1/4"		
Body material	CUPLA: Brass (Nickel plated) Plate: Aluminum alloy Locking unit: Steel (Nickel plated)				
Pressure unit	MPa	kgf/cm <sup>2</sup>	bar	PSI	
Working pressure	1.0	10	10	145	
Ambient temperature range	0°C to +60°C				
Seal material	Sealing material	Mark	Working temperature range	Remarks	
Working temperature range *1	Fluoro rubber	FKM	-20°C to +180°C	Standard material	

\*1: The operable temperature range depends on the operating conditions.

Maximum Tightening Torque		Nm {kgf·cm}
Size (Thread)	1/8"	1/4"
Torque	5 {51}	9 {92}

### Interchangeability

No connection is possible between plates with different number of ports or different size.

### Minimum Cross-Sectional Area per Port (mm<sup>2</sup>)

Model	1SP type	2SP type
Minimum cross-sectional area	14	26

### Suitability for Vacuum 1.3×10<sup>-1</sup> Pa {1×10<sup>-3</sup> mmHg}

Socket only	Plug only	When connected
—	—	Operational

### Admixture of Air on Connection per Port May vary depending upon the usage conditions. (mL)

Model	1SP type	2SP type
Volume of air	0.6	1.1

### Volume of Spillage on Disconnection per Port May vary depending upon the usage conditions. (mL)

Model	1SP type	2SP type
Volume of spillage	0.4	0.8

### Flow Rate - Pressure Loss Characteristics Per port of CUPLA

[Test conditions] - Fluid : Water - Temperature : 23°C±5°C

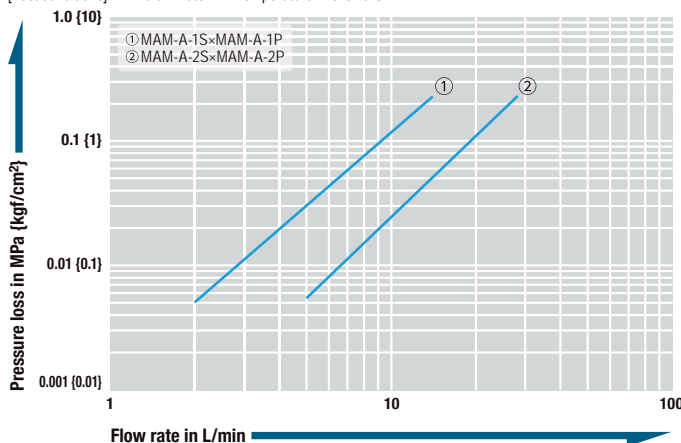

Models and Dimensions

Model MAM-B-1P8×MAM-B-1S8 (8 ports type)

• Application (Thread): R 1/8 Mass: 660 g (Plug), 1210 g (Socket)

Dimensions (mm)

Plate with CUPLA  
MAM-B Type

8  
Ports

Socket: Model  
MAM-B-1S8

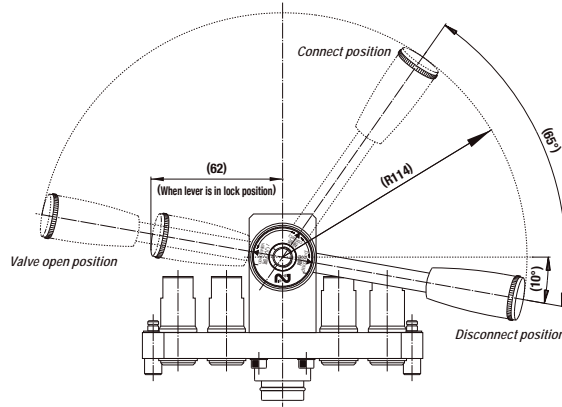

Plug: Model  
MAM-B-1P8

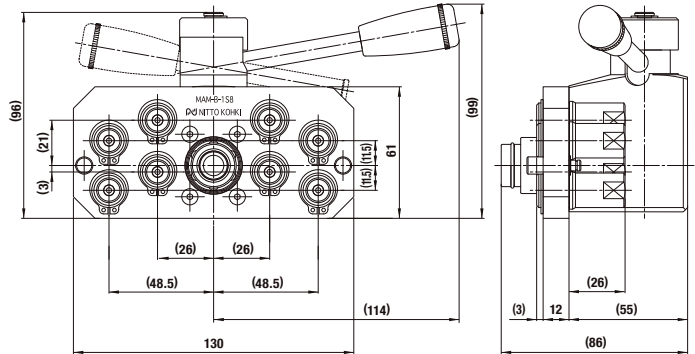
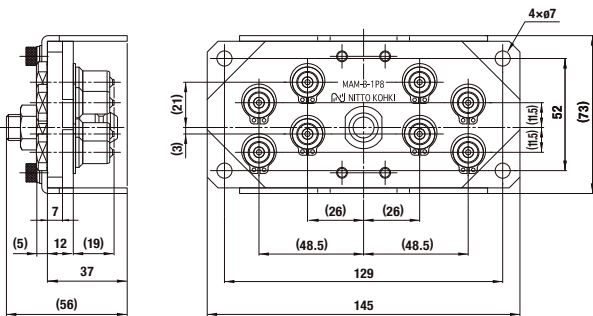

Model MAM-B-1P12×MAM-B-1S12 (12 ports type)

• Application (Thread): R 1/8 Mass: 790 g (Plug), 1430 g (Socket)

Dimensions (mm)

Plate with CUPLA  
MAM-B Type

12  
Ports

Socket: Model  
MAM-B-1S12

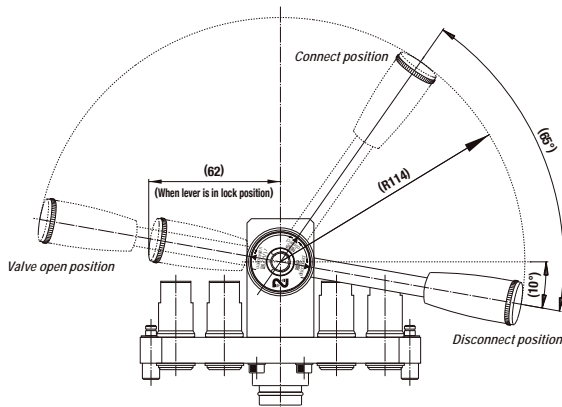

Plug: Model  
MAM-B-1P12

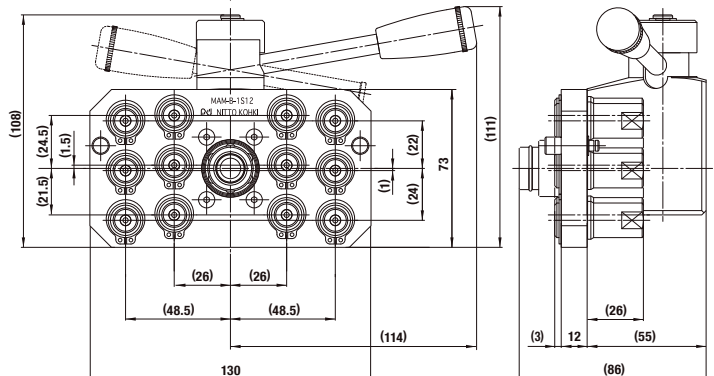
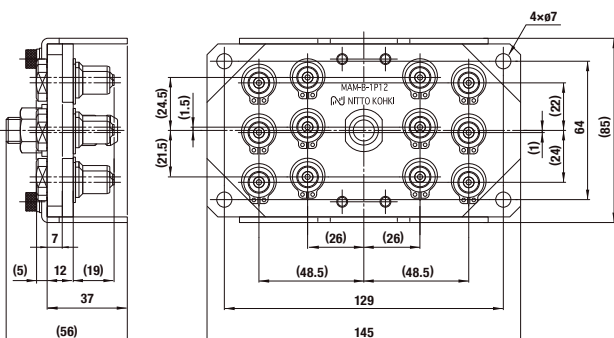

Plug Model MAM-A-1P (Individual CUPLA)

• Application (Thread): R 1/8 Mass: 25 g  
• Can be mounted on model MAM-B-1P8 and MAM-B-1P12.

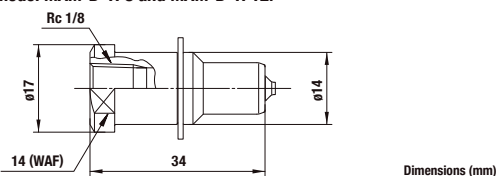

Socket Model MAM-A-1S (Individual CUPLA)

• Application (Thread): R 1/8 Mass: 49 g  
• Can be mounted on model MAM-B-1S8 and MAM-B-1S12.

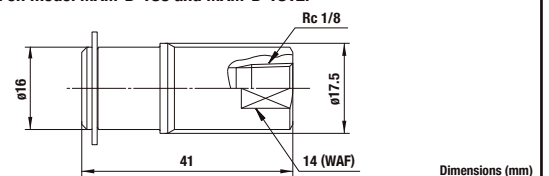

Made-to-order MULTI CUPLA is available on request, such as a combination of different sizes on the flange plate.



**Model MAM-B-2P6×MAM-B-2S6 (6 ports type)**

• Application (Thread): R 1/4 Mass: 740 g (Plug), 1280 g (Socket)

Plate with CUPLA  
**MAM-B Type**

**6**  
Ports

Dimensions (mm)

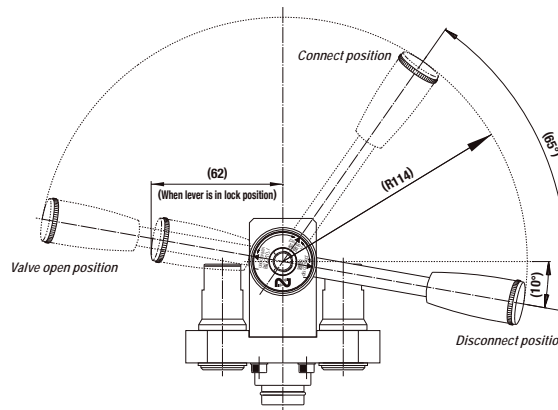

Socket: Model  
**MAM-B-2S6**

Plug: Model  
**MAM-B-2P6**

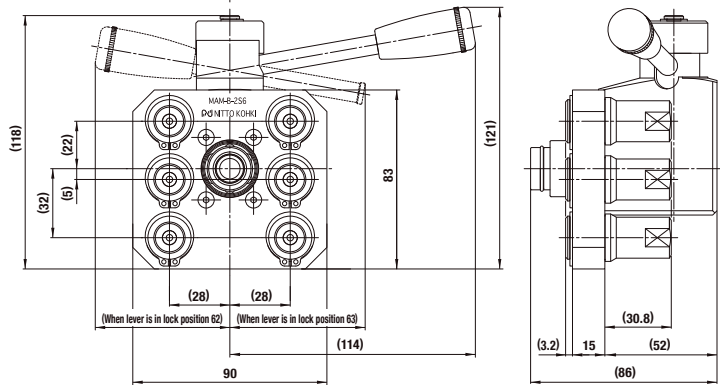
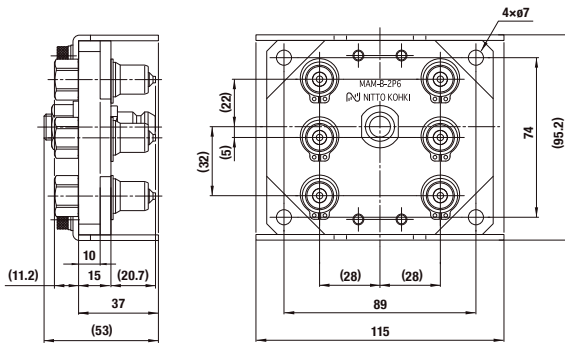

**Model MAM-B-2P8×MAM-B-2S8 (8 ports type)**

• Application (Thread): R 1/4 Mass: 920 g (Plug), 1550 g (Socket)

Plate with CUPLA  
**MAM-B Type**

**8**  
Ports

Dimensions (mm)

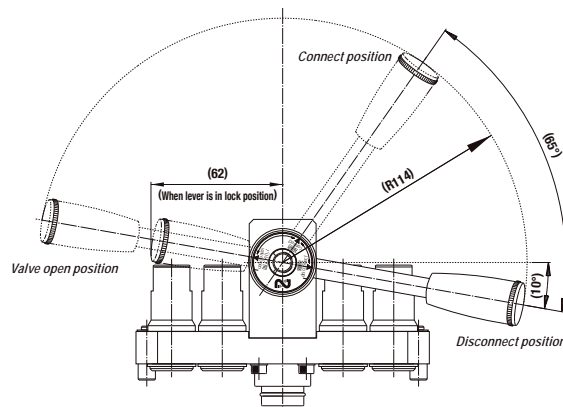

Socket: Model  
**MAM-B-2S8**

Plug: Model  
**MAM-B-2P8**

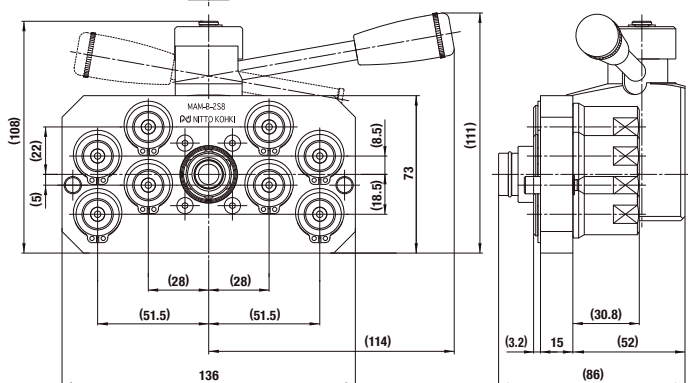
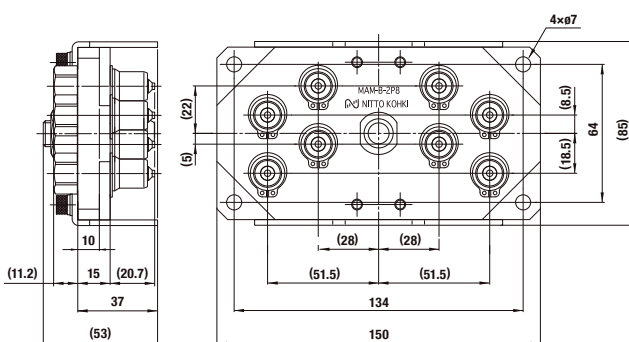

**Plug Model MAM-A-2P (Individual CUPLA)**

• Application (Thread): R 1/4 Mass: 40 g  
• Can be mounted on model MAM-B-2P6 and MAM-B-2P8.

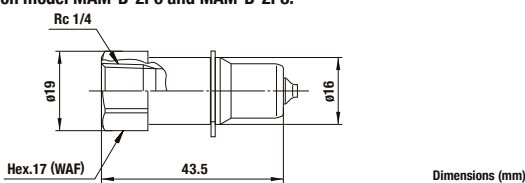

**Socket Model MAM-A-2S (Individual CUPLA)**

• Application (Thread): R 1/4 Mass: 82 g  
• Can be mounted on model MAM-B-2S6 and MAM-B-2S8.

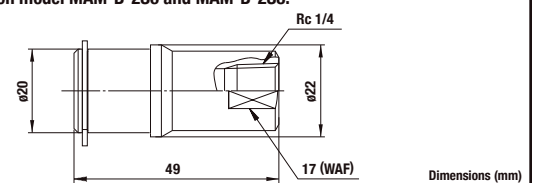

Made-to-order MULTI CUPLA is available on request, such as a combination of different sizes on the flange plate.

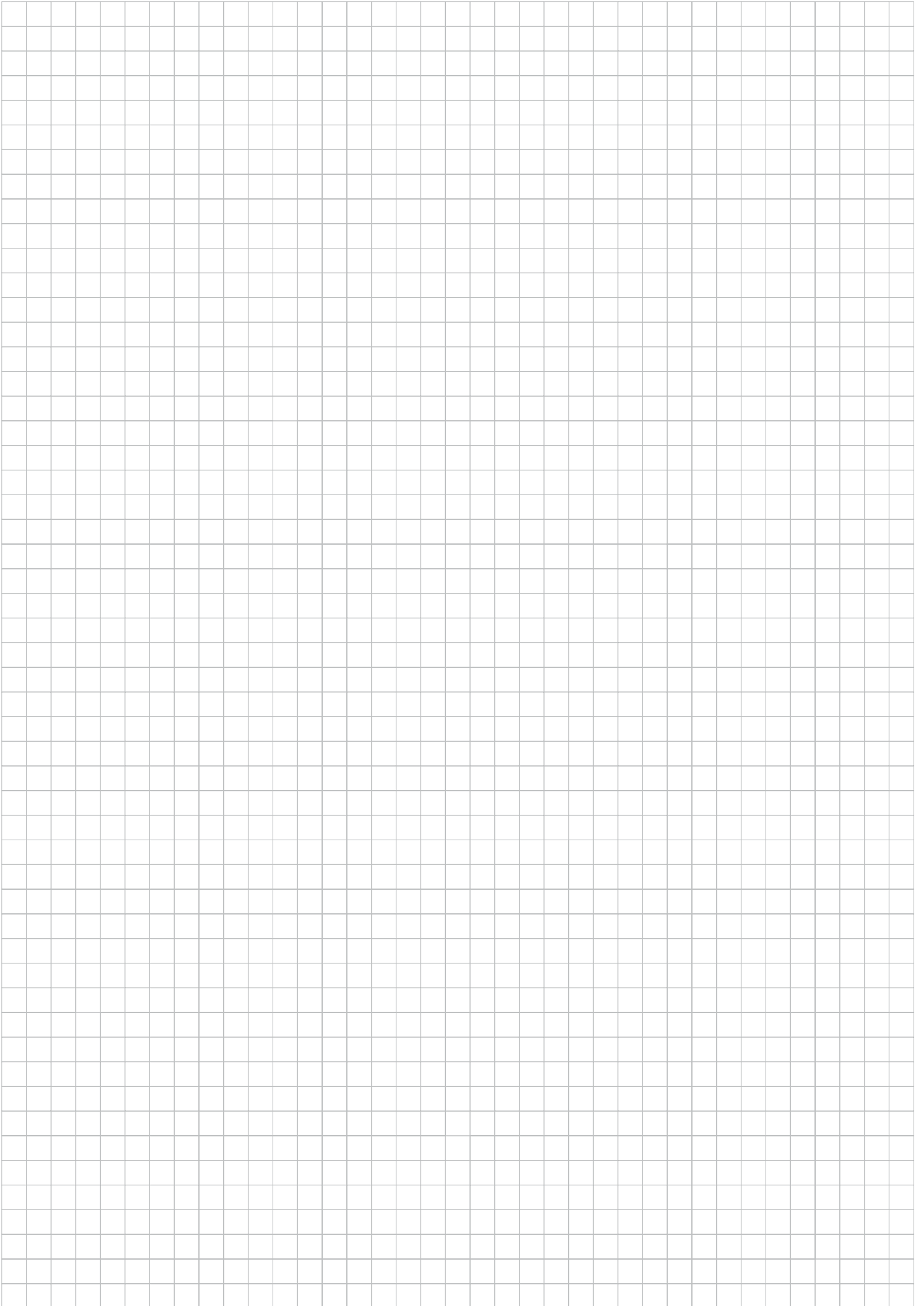

For Multi-Port Connection (Manual)

# MULTI CUPLA MAM-A Type

Multiple port system

Working pressure



1.0 MPa  
(10 kgf/cm<sup>2</sup>)

Valve structure



Two-way shut-off

Applicable fluids



Air

Water

Simultaneously connects several ports securely in one operation!  
Greatly reduces changeover time in multiple ports replacement.

- Handles several ports at once.
- Simple manual lever action completes easy connection/disconnection.
- Two-stage lever operation prevents CUPLA from accidental dropping due to sudden detachment.
- Comes with lock mechanism to prevent accidental disconnection.
- Large flow equivalent to that of SP CUPLA Type A.
- Two kinds of plates are available for each size.
- Automatic shut-off valves in both socket and plug prevent fluid spill out on disconnection.
- Self-aligned valve design provides safety sealing of individual socket or plug when disconnected.

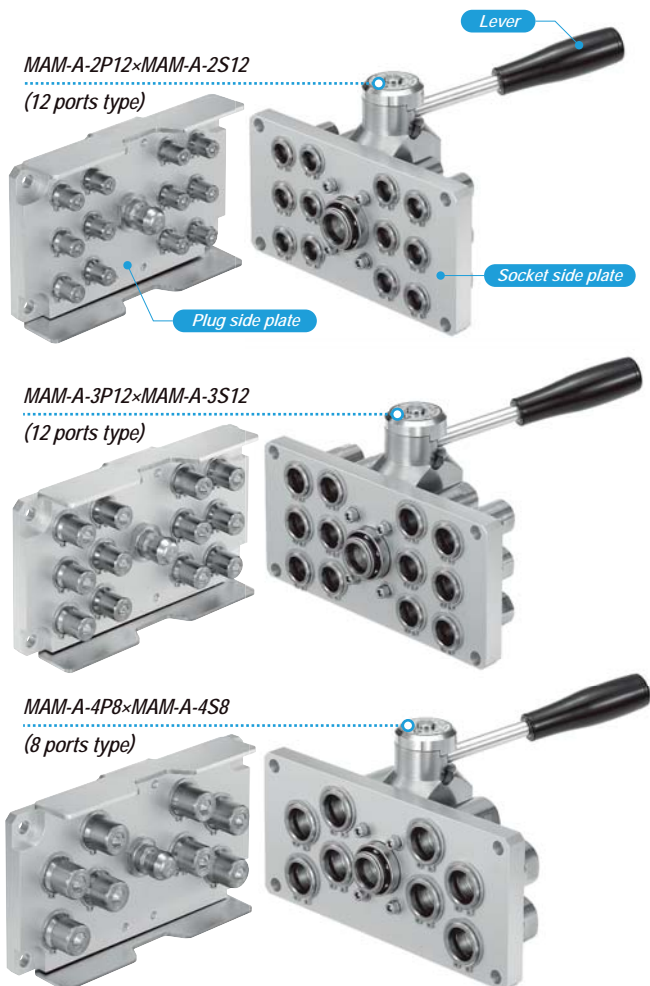

## Specifications

Model	Plug	MAM-A-2P12	MAM-A-3P6	MAM-A-3P12	MAM-A-4P4	MAM-A-4P8
	Socket	MAM-A-2S12	MAM-A-3S6	MAM-A-3S12	MAM-A-4S4	MAM-A-4S8
Number of ports		12	6	12	4	8
Size (Thread)		1/4"	3/8"		1/2"	
Body material		CUPLA: Brass (Nickel plated) Plate: Aluminum alloy Locking unit: Steel (Nickel plated)				
Pressure unit		MPa	kgf/cm <sup>2</sup>	bar	PSI	
Working pressure		1.0	10	10	145	
Ambient temperature range		0°C to +60°C				
Seal material	Sealing material	Mark	Working temperature range	Remarks		
Working temperature range *1	Fluoro rubber	FKM	-20°C to +180°C	Standard material		

\*1: The operable temperature range depends on the operating conditions.

## Maximum Tightening Torque

Nm {kgf·cm}

Size (Thread)	1/4"	3/8"	1/2"
Torque	9 {92}	12 {122}	30 {306}

## Interchangeability

No connection is possible between plates with different number of ports or different size.

## Minimum Cross-Sectional Area per Port

(mm<sup>2</sup>)

Model	2SP type	3SP type	4SP type
Minimum cross-sectional area	26	51	73

## Suitability for Vacuum

1.3×10<sup>-1</sup> Pa {1×10<sup>-3</sup> mmHg}

Socket only	Plug only	When connected
—	—	Operational

## Admixture of Air on Connection per Port

May vary depending upon the usage conditions.

(mL)

Model	2SP type	3SP type	4SP type
Volume of air	1.1	2.7	3.9

## Volume of Spillage on Disconnection per Port

May vary depending upon the usage conditions.

(mL)

Model	2SP type	3SP type	4SP type
Volume of spillage	0.8	2.1	3.4

## Flow Rate - Pressure Loss Characteristics

Per port of CUPLA

[Test conditions] - Fluid : Water - Temperature : 23°C±5°C

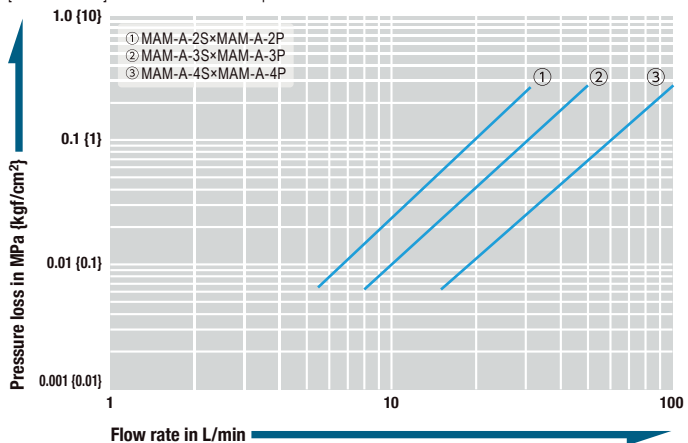

Models and Dimensions

Model MAM-A-2P12×MAM-A-2S12 (12 ports type)

- Application (Thread): R 1/4 Mass: 1650 g (Plug), 2800 g (Socket)

Dimensions (mm)

Plate with CUPLA  
MAM-A Type

12  
Ports

Socket: Model  
MAM-A-2S12

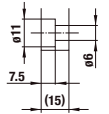
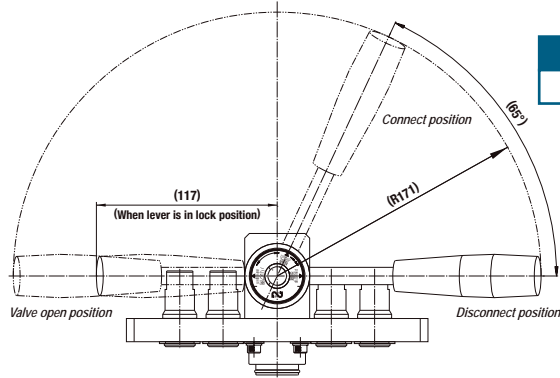

Cross section A-A  
(4 corners)

Plug: Model  
MAM-A-2P12

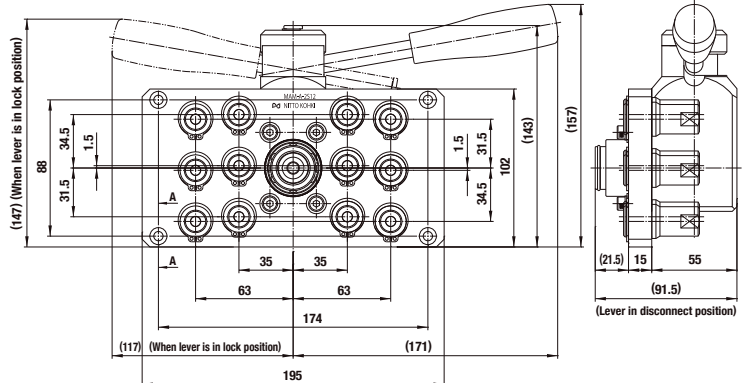
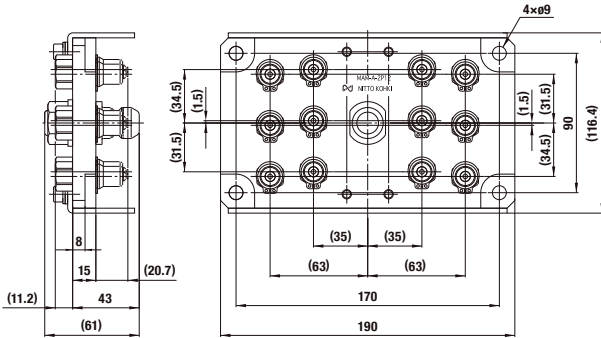

Plug Model MAM-A-2P (Individual CUPLA)

- Application (Thread): R 1/4 Mass: 40 g
- Can be mounted on model MAM-A-2P12.

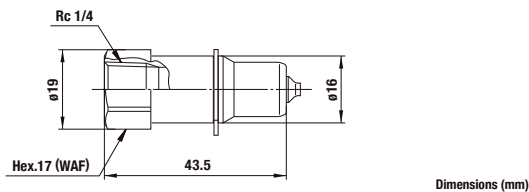

Socket Model MAM-A-2S (Individual CUPLA)

- Application (Thread): R 1/4 Mass: 82 g
- Can be mounted on model MAM-A-2S12.

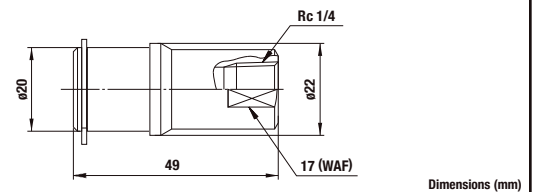

Made-to-order MULTI CUPLA is available on request, such as a combination of different sizes on the flange plate.



**Model MAM-A-3P6×MAM-A-3S6 (6 ports type)**

• Application (Thread): R 3/8 Mass: 1250 g (Plug), 2400 g (Socket)

Dimensions (mm)

Plate with CUPLA  
**MAM-A Type**

**6**  
Ports

Socket: Model  
**MAM-A-3S6**

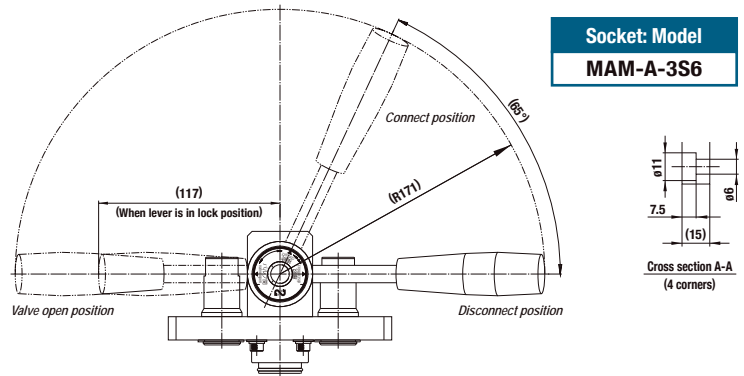

Plug: Model  
**MAM-A-3P6**

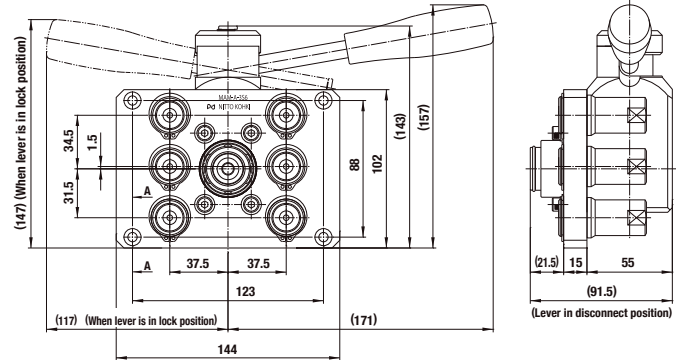
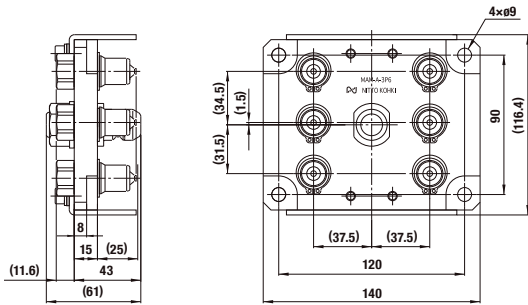

**Model MAM-A-3P12×MAM-A-3S12 (12 ports type)**

• Application (Thread): R 3/8 Mass: 1950 g (Plug), 3300 g (Socket)

Dimensions (mm)

Plate with CUPLA  
**MAM-A Type**

**12**  
Ports

Socket: Model  
**MAM-A-3S12**

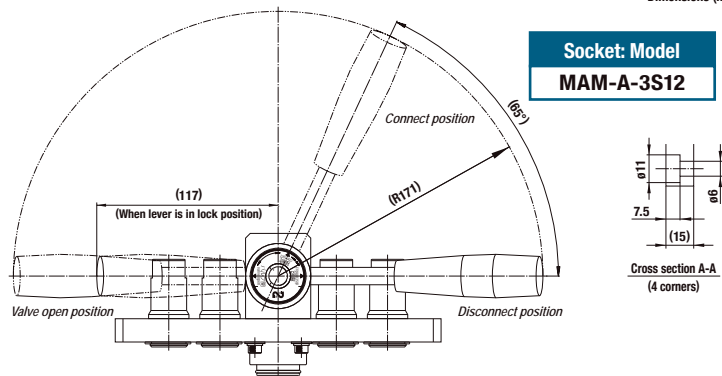

Plug: Model  
**MAM-A-3P12**

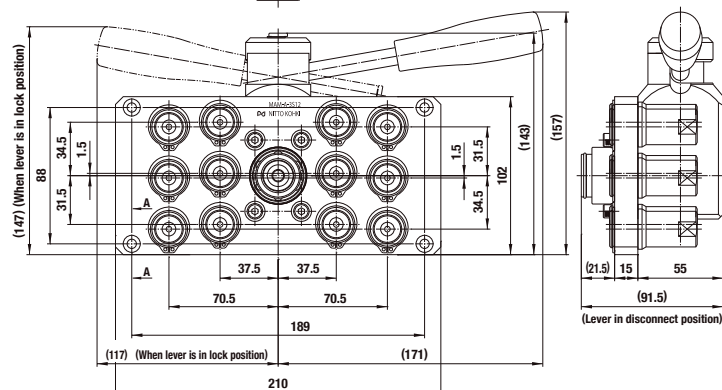
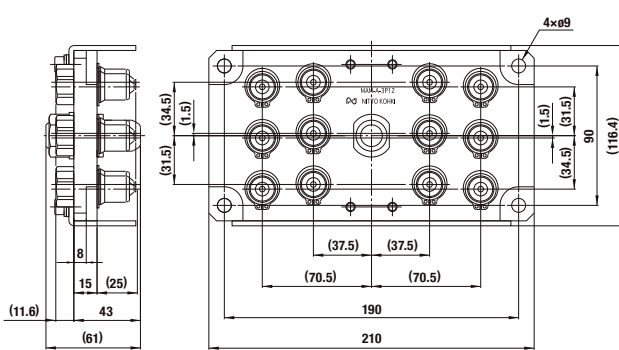

**Plug Model MAM-A-3P (Individual CUPLA)**

• Application (Thread): R 3/8 Mass: 62 g  
• Can be mounted on model MAM-A-3P6 and MAM-A-3P12.

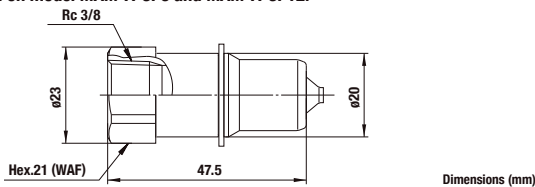

**Socket Model MAM-A-3S (Individual CUPLA)**

• Application (Thread): R 3/8 Mass: 122 g  
• Can be mounted on model MAM-A-3S6 and MAM-A-3S12.

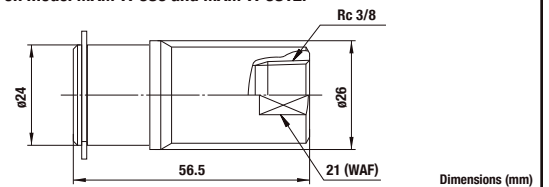

Made-to-order MULTI CUPLA is available on request, such as a combination of different sizes on the flange plate.

Models and Dimensions

Model MAM-A-4P4×MAM-A-4S4 (4 ports type)

• Application (Thread): R 1/2 Mass: 1400 g (Plug), 2700 g (Socket)

Dimensions (mm)

Plate with CUPLA  
MAM-A Type

4  
Ports

Socket: Model  
MAM-A-4S4

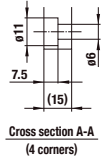
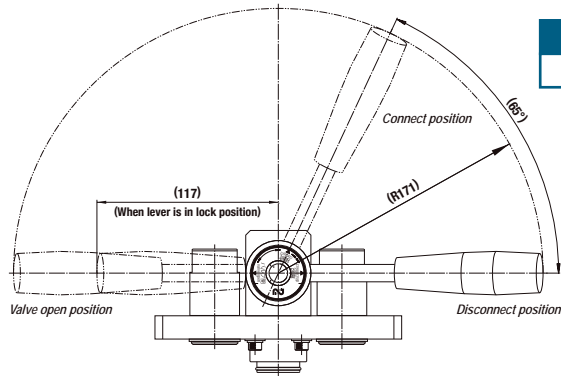

Plug: Model  
MAM-A-4P4

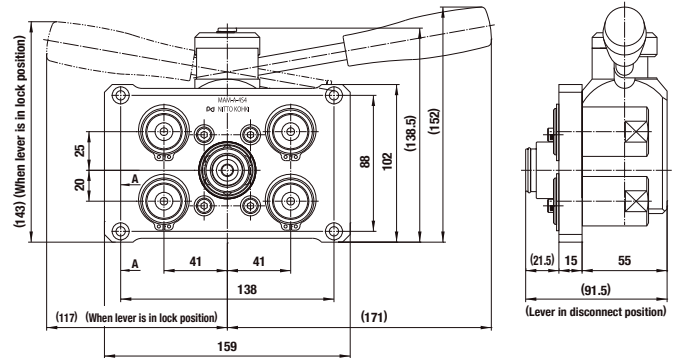
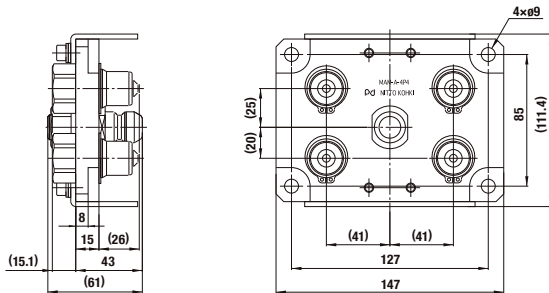

Model MAM-A-4P8×MAM-A-4S8 (8 ports type)

• Application (Thread): R 1/2 Mass: 2300 g (Plug), 4000 g (Socket)

Dimensions (mm)

Plate with CUPLA  
MAM-A Type

8  
Ports

Socket: Model  
MAM-A-4S8

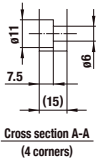
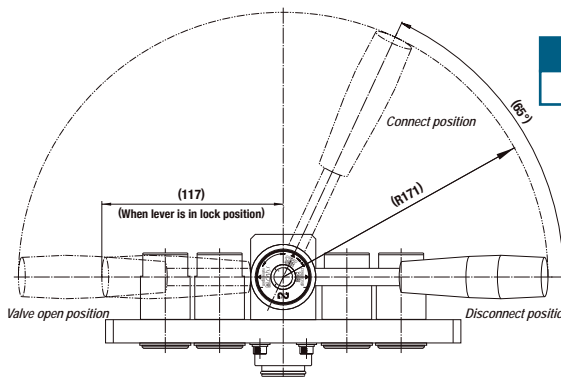

Plug: Model  
MAM-A-4P8

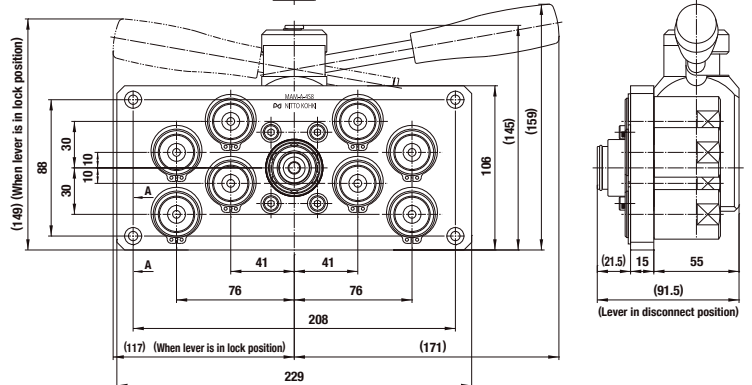
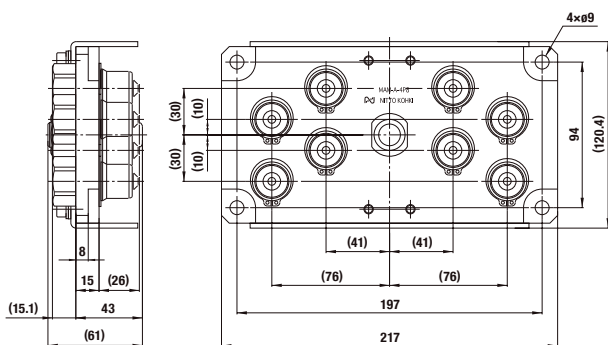

Plug Model MAM-A-4P (Individual CUPLA)

• Application (Thread): R 1/2 Mass: 127 g  
• Can be mounted on model MAM-A-4P4 and MAM-A-4P8.

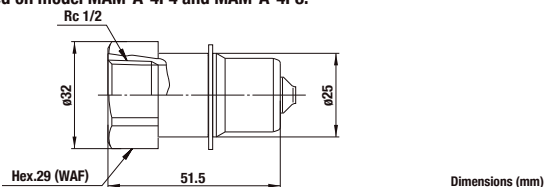

Socket Model MAM-A-4S (Individual CUPLA)

• Application (Thread): R 1/2 Mass: 256 g  
• Can be mounted on model MAM-A-4S4 and MAM-A-4S8.

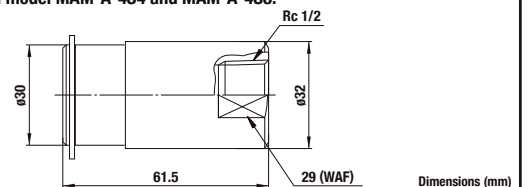

Made-to-order MULTI CUPLA is available on request, such as a combination of different sizes on the flange plate.

For Multi-Port Connection (Manual)

# MULTI CUPLA

## MAM-A-SP Type

For mounting onto plates of MULT CUPLA MAM-A / MAM-B Type

Working pressure



Valve structure



Applicable fluids



## Individual CUPLA for mounting onto plates of MULTI CUPLA MAM-A / MAM-B Type.

- Large flow equivalent to that of SP CUPLA Type A.
- Automatic shut-off valves in both socket and plug prevent fluid spill out on disconnection.
- Self-aligned valve design provides safety sealing of individual socket or plug when disconnected.

### MULTI CUPLA series and plates that can mount MAM-A-SP Type

MAM-B Type (See page 115 to 117)

MAM-B Type plate (See page 126 to 127)

MAM-A Type (See page 119 to 122)

MAM-A Type plate (See page 128 to 130)



### Specifications (Individual CUPLA)

Model	Plug	MAM-A-1P	MAM-A-2P	MAM-A-3P	MAM-A-4P
	Socket	MAM-A-1S	MAM-A-2S	MAM-A-3S	MAM-A-4S
Size (Thread)		Rc 1/8	Rc 1/4	Rc 3/8	Rc 1/2
Body material	Brass (Nickel plated)				
Pressure unit	MPa	kgf/cm <sup>2</sup>	bar	PSI	
Working pressure		1.0	10	10	145
Seal material	Sealing material	Mark	Working temperature range	Remarks	
Working temperature range <sup>*1</sup>	Fluoro rubber	FKM	-20°C to +180°C	Standard material	

\* The specifications when used with individual CUPLA mounted onto the plate, conform to the specifications of the individual CUPLA.

\*1: The operable temperature range depends on the operating conditions.

### Maximum Tightening Torque

Nm {kgf·cm}

Size (Thread)	Rc 1/8	Rc 1/4	Rc 3/8	Rc 1/2
Torque	5 {51}	9 {92}	12 {122}	30 {306}

### Interchangeability

No connection is possible between plates with different number of ports or different size.

### Minimum Cross-Sectional Area per Port

(mm<sup>2</sup>)

Model	MAM-A-1S×MAM-A-1P	MAM-A-2S×MAM-A-2P	MAM-A-3S×MAM-A-3P	MAM-A-4S×MAM-A-4P
Minimum cross-sectional area	14	26	51	73

### Suitability for Vacuum

1.3×10<sup>-1</sup> Pa {1×10<sup>-3</sup> mmHg}

Socket only	Plug only	When connected
—	—	Operational

### Admixture of Air on Connection per Port

May vary depending upon the usage conditions.

(mL)

Model	MAM-A-1S×MAM-A-1P	MAM-A-2S×MAM-A-2P	MAM-A-3S×MAM-A-3P	MAM-A-4S×MAM-A-4P
Volume of air	0.6	1.1	2.7	3.9

### Volume of Spillage on Disconnection per Port

May vary depending upon the usage conditions.

(mL)

Model	MAM-A-1S×MAM-A-1P	MAM-A-2S×MAM-A-2P	MAM-A-3S×MAM-A-3P	MAM-A-4S×MAM-A-4P
Volume of spillage	0.4	0.8	2.1	3.4

### Flow Rate - Pressure Loss Characteristics

[Test conditions] - Fluid : Water - Temperature : 23°C±5°C

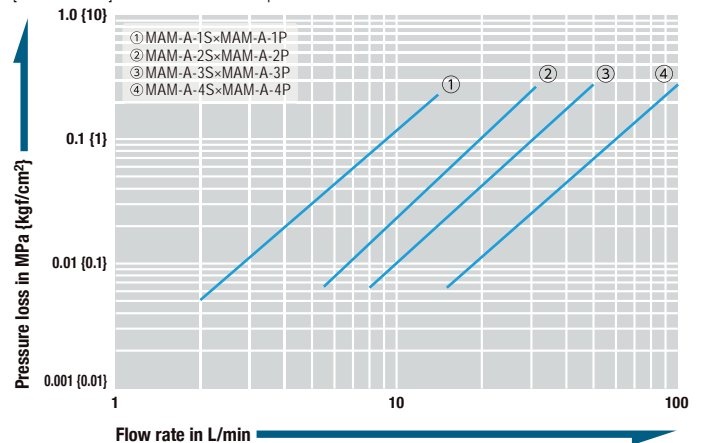

### Models and Dimensions

WAF : WAF stands for width across flats.

#### Plug For mounting onto plug side plate (Female thread)

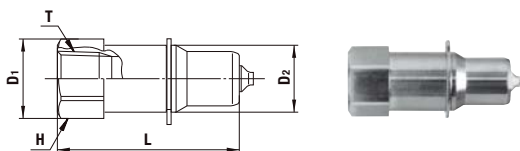

Model	Application (Thread)	Mass (g)	Dimensions (mm)				
			L	øD1	øD2	H (WAF)	T
MAM-A-1P	R 1/8	25	34	17	14	14	Rc 1/8
MAM-A-2P	R 1/4	40	43.5	19	16	Hex.17	Rc 1/4
MAM-A-3P	R 3/8	62	47.5	23	20	Hex.21	Rc 3/8
MAM-A-4P	R 1/2	127	51.5	32	25	Hex.29	Rc 1/2

#### Socket For mounting onto socket side plate (Female thread)

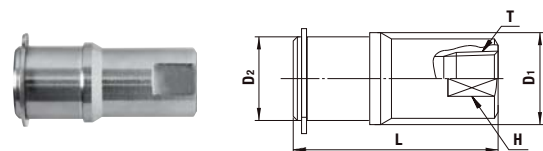

Model	Application (Thread)	Mass (g)	Dimensions (mm)				
			L	øD1	øD2	H (WAF)	T
MAM-A-1S	R 1/8	49	41	17.5	16	14	Rc 1/8
MAM-A-2S	R 1/4	82	49	22	20	17	Rc 1/4
MAM-A-3S	R 3/8	122	56.5	26	24	21	Rc 3/8
MAM-A-4S	R 1/2	256	61.5	32	30	29	Rc 1/2

Valve-less (Plug and Socket without valve) are available on request as made-to-order versions. In such case, the model name ends with "-VL". (ex: MAM-A-2P-VL)

For Multi-Port Connection (Manual)

# MULTI CUPLA

## MAM-A-ZEL Type

For mounting onto plates of MULTI CUPLA MAM-A / MAM-B Type

Working pressure  1.0 MPa (10 kgf/cm<sup>2</sup>)

Valve structure  Two-way shut-off (Spill Reduction)

Applicable fluids  Air Water

Individual CUPLA for mounting onto plates of MULTI CUPLA MAM-A / MAM-B Type. Their “airless valve shut-off design” greatly reduces both liquid spillage and air admixture.

- Original valve structure reduces both liquid spillage and air admixture on connection and disconnection.
- Automatic shut-off valves in both socket and plug prevent fluid spill out on disconnection.

### MULTI CUPLA series and plates that can mount MAM-A-ZEL Type

MAM-B Type\* (See page 115 to 117)



MAM-B Type plate\* (See page 126 to 127)

MAM-A Type (See page 119 to 122)

MAM-A Type plate (See page 128 to 130)

\*Excluding size Rc 1/8



MAM-A-SP Type  MAM-A-ZEL Type 

**Typical spillage**  
(6 ports of size 1/4")  
**4.8 mL → 0.36 mL**  
(May vary. Depends on the application.)

### Specifications (Individual CUPLA)

Model	Plug	MAM-A-ZEL-2P	MAM-A-ZEL-3P	MAM-A-ZEL-4P
	Socket	MAM-A-ZEL-2S	MAM-A-ZEL-3S	MAM-A-ZEL-4S
Size (Thread)		Rc 1/4	Rc 3/8	Rc 1/2
Body material		Brass (Nickel plated)		
Pressure unit		MPa	kgf/cm <sup>2</sup>	bar
Working pressure		1.0	10	10
Seal material	Sealing material	Mark	Working temperature range	Remarks
Working temperature range *1	Fluoro rubber	FKM	-20 °C to +180 °C	Standard material

- Do not use in an environment where there is impulse pressure.

\*1: The operable temperature range depends on the operating conditions.

### Maximum Tightening Torque

Nm {kgf·cm}

Size (Thread)	Rc 1/4	Rc 3/8	Rc 1/2
Torque	9 {92}	12 {122}	30 {306}

### Interchangeability

No connection is possible between plates with different number of ports or different size.

### Minimum Cross-Sectional Area per Port

(mm<sup>2</sup>)

Model	MAM-A-ZEL-2S×MAM-A-ZEL-2P	MAM-A-ZEL-3S×MAM-A-ZEL-3P	MAM-A-ZEL-4S×MAM-A-ZEL-4P
Minimum cross-sectional area	31	60.5	86.5

### Suitability for Vacuum

1.3×10<sup>-1</sup> Pa {1×10<sup>-3</sup> mmHg}

Socket only	Plug only	When connected
—	—	Operational

### Admixture of Air on Connection per Port

May vary depending upon the usage conditions. (mL)

Model	MAM-A-ZEL-2S×MAM-A-ZEL-2P	MAM-A-ZEL-3S×MAM-A-ZEL-3P	MAM-A-ZEL-4S×MAM-A-ZEL-4P
Volume of air	0.16	0.21	0.39

### Volume of Spillage on Disconnection per Port

May vary depending upon the usage conditions. (mL)

Model	MAM-A-ZEL-2S×MAM-A-ZEL-2P	MAM-A-ZEL-3S×MAM-A-ZEL-3P	MAM-A-ZEL-4S×MAM-A-ZEL-4P
Volume of spillage	0.06	0.12	0.15

### Flow Rate - Pressure Loss Characteristics

[Test conditions] - Fluid : Water - Temperature : 23°C±5°C

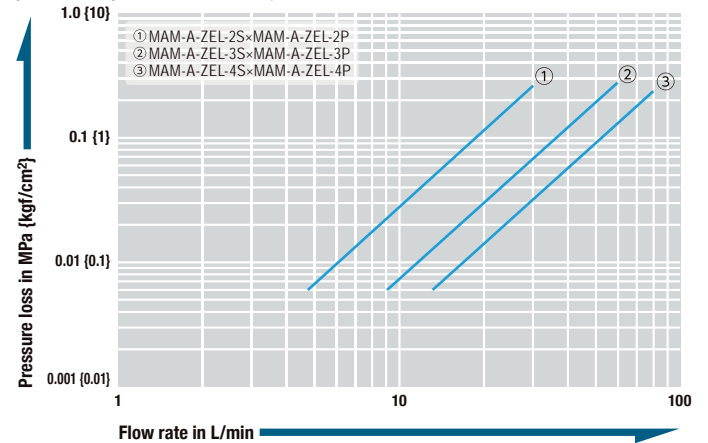

### Models and Dimensions

WAF : WAF stands for width across flats.

#### Plug For mounting onto plug side plate (Female thread)

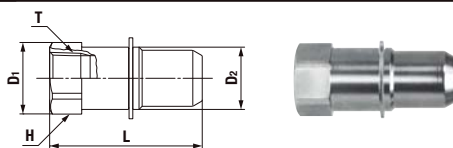

Model	Application (Thread)	Mass (g)	Dimensions (mm)				
			L	øD1	øD2	H	
MAM-A-ZEL-2P	R 1/4	42	47	19	16	Hex.17	Rc 1/4
MAM-A-ZEL-3P	R 3/8	64	49	23	20	Hex.21	Rc 3/8
MAM-A-ZEL-4P	R 1/2	123	55	32	25	Hex.29	Rc 1/2

#### Socket For mounting onto socket side plate (Female thread)

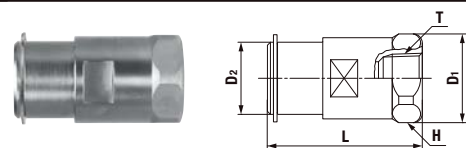

Model	Application (Thread)	Mass (g)	Dimensions (mm)				
			L	øD1	øD2	H	
MAM-A-ZEL-2S	R 1/4	78	46	23	20	Hex.21	Rc 1/4
MAM-A-ZEL-3S	R 3/8	129	51.5	24	29.5	Hex.27	Rc 3/8
MAM-A-ZEL-4S	R 1/2	210	59	35	30	Hex.32	Rc 1/2

One way valve types (Plug without valve) are available on request as made-to-order versions. In such case, the model name ends with "-VL". (ex: MAM-A-ZEL-2P-VL)

For Multi-Port Connection (Manual)

# MULTI CUPLA

Plate for mounting  
MAM-A-ZEL / MAM-A-SP Type

## Plates for mounting MULTI CUPLA MAM-A-ZEL and MAM-A-SP Type.

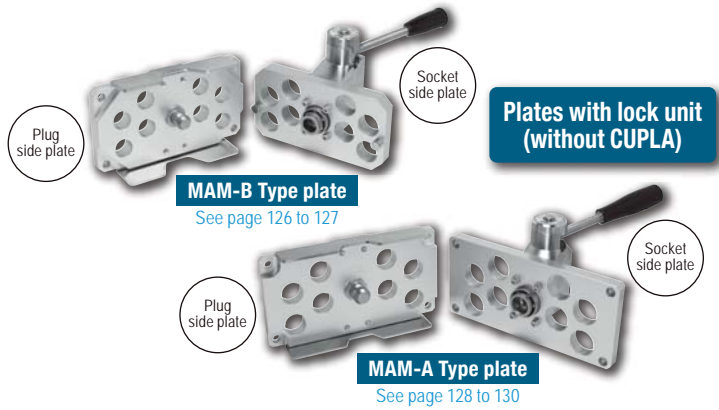

### Specifications (Individual plate)

Plate type	MAM-B Type				MAM-A Type						
Model	Plug side	MAM-B-1P8-CL	MAM-B-1P12-CL	MAM-B-2P6-CL	MAM-B-2P8-CL	MAM-A-2P6-CL	MAM-A-2P12-CL	MAM-A-3P6-CL	MAM-A-3P12-CL	MAM-A-4P4-CL	MAM-A-4P8-CL
	Socket side	MAM-B-1S8-CL	MAM-B-1S12-CL	MAM-B-2S6-CL	MAM-B-2S8-CL	MAM-A-2S6-CL	MAM-A-2S12-CL	MAM-A-3S6-CL	MAM-A-3S12-CL	MAM-A-4S4-CL	MAM-A-4S8-CL
Number of ports	8	12	6	8	6	12	6	12	4	8	
Body material	Aluminum alloy										
Ambient temperature range	0°C to +60°C										

Select the most suitable combination in accordance with your operating conditions.

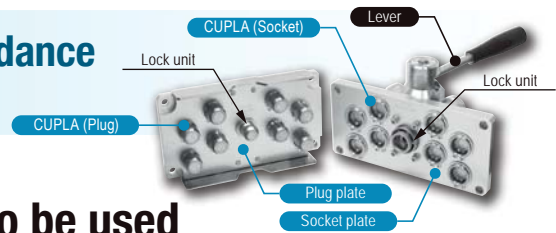

## 1 Decide the [Type] and [Size] of CUPLA to be used

### CUPLA

Low spill type	Plug	Size (Thread)	Model
MAM-A-ZEL Type		1/8	—
		1/4	MAM-A-ZEL-2P
		3/8	MAM-A-ZEL-3P
		1/2	MAM-A-ZEL-4P

See page 124

Low spill type	Socket	Size (Thread)	Model
MAM-A-ZEL Type		1/8	—
		1/4	MAM-A-ZEL-2S
		3/8	MAM-A-ZEL-3S
		1/2	MAM-A-ZEL-4S

See page 124

General purpose type	Plug	Size (Thread)	Model
MAM-A-SP Type		1/8	MAM-A-1P
		1/4	MAM-A-2P
		3/8	MAM-A-3P
		1/2	MAM-A-4P

See page 123

General purpose type	Socket	Size (Thread)	Model
MAM-A-SP Type		1/8	MAM-A-1S
		1/4	MAM-A-2S
		3/8	MAM-A-3S
		1/2	MAM-A-4S

See page 123

Interchangeable

Same size only

No interchangeability

Interchangeable

Same size only

MAM-A-ZEL and MAM-A-SP Type can be mounted on the same plates.

Note: MAM-A-ZEL Type is not interchangeable with the MAM-A-SP Type.

One way valve for MAM-A-ZEL (Plug without valve) and valve-less MAM-A-SP (Plug and Socket without valve) are available on request as made-to-order versions.

In such case, the model name ends with "-VL".  
(ex: MAM-A-2P-VL)

## 2 Specify the required number of [Port]s

## 3 Select the [Plate]

Note: If CUPLA size is 1/4" and the number of ports is 6, either plate for MAM-A or MAM-B can be used. (Choose either one by the outer dimensions)

### Plate

Coupling body	Size (Thread)	Number of ports	Plate model of Plug side	Plate model of Socket side	Outer dimensions
MAM-A-ZEL Type MAM-A-SP Type	1/8	8	MAM-B-1P8-CL	MAM-B-1S8-CL	See page 126
		12	MAM-B-1P12-CL	MAM-B-1S12-CL	See page 126
	1/4	6	MAM-A-2P6-CL	MAM-A-2S6-CL	See page 128
			MAM-B-2P6-CL	MAM-B-2S6-CL	See page 127
		8	MAM-B-2P8-CL	MAM-B-2S8-CL	See page 127
			MAM-A-2P12-CL	MAM-A-2S12-CL	See page 128
	3/8	6	MAM-A-3P6-CL	MAM-A-3S6-CL	See page 129
			MAM-A-3P12-CL	MAM-A-3S12-CL	See page 129
		4	MAM-A-4P4-CL	MAM-A-4S4-CL	See page 130
			8	MAM-A-4P8-CL	MAM-A-4S8-CL

In order to balance the force of system pressure, place each CUPLA symmetrically from the lock unit (center).



Models and Dimensions

Model MAM-B-1P8-CL×MAM-B-1S8-CL (8 Ports Type / Plate size : Small)

• Application (Thread): R 1/8 Mass: 460 g (Plug), 818 g (Socket)

Dimensions (mm)

Plate without CUPLA **MAM-B Type**

**8**  
Ports

Applicable CUPLA (See page 123)	Plug	Socket
	MAM-A-1P	MAM-A-1S

Plate model of Socket side  
**MAM-B-1S8-CL**

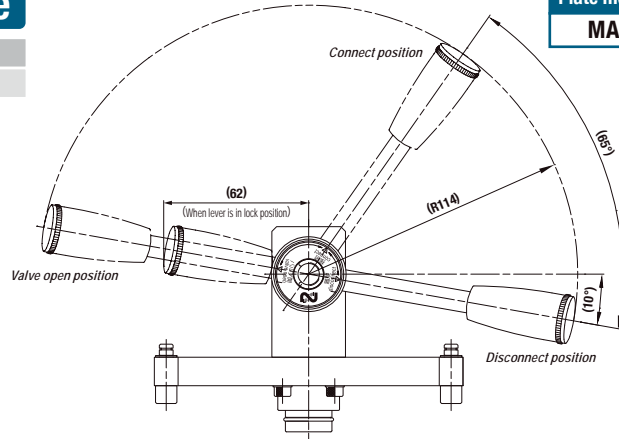
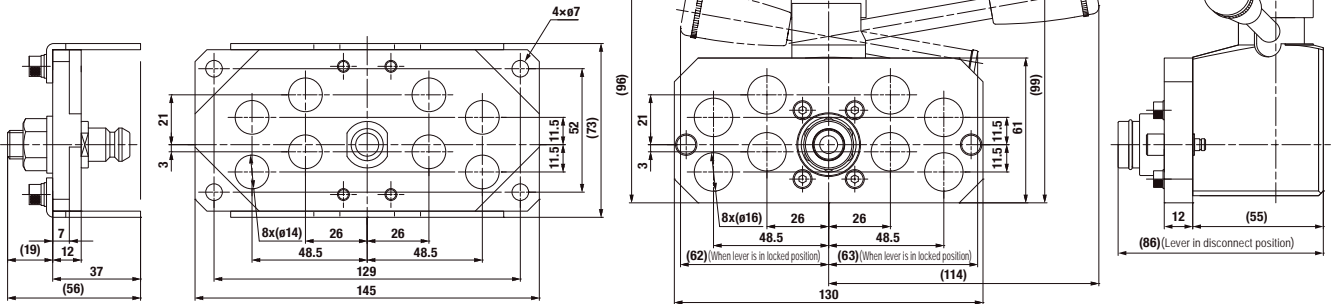

Plate model of Plug side  
**MAM-B-1P8-CL**



Model MAM-B-1P12-CL×MAM-B-1S12-CL (8 Ports Type / Plate size : Large)

• Application (Thread): R 1/8 Mass: 490 g (Plug), 842 g (Socket)

Dimensions (mm)

Plate without CUPLA **MAM-B Type**

**12**  
Ports

Applicable CUPLA (See page 123)	Plug	Socket
	MAM-A-1P	MAM-A-1S

Plate model of Socket side  
**MAM-B-1S12-CL**

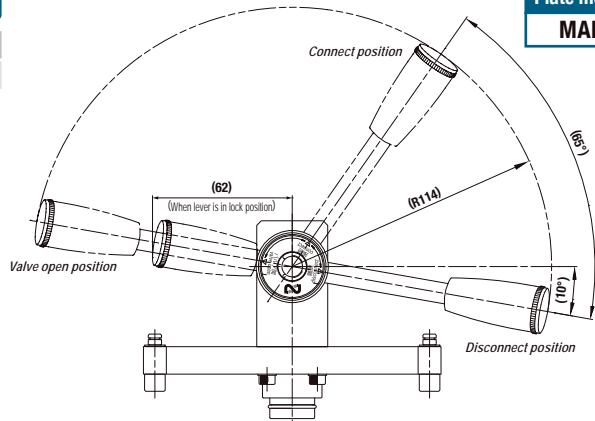
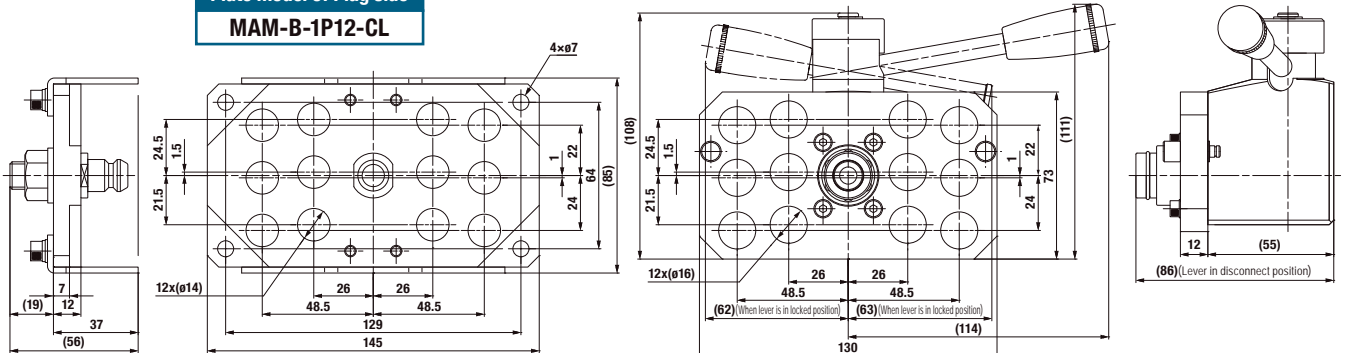

Plate model of Plug side  
**MAM-B-1P12-CL**



Made-to-order MULTI CUPLA is available on request, such as a combination of different sizes on the flange plate.

Before use, please be sure to read "Safety Guide" described at the end of this book and "Instruction Sheet" that comes with the products.

Models and Dimensions

Model MAM-B-2P6-CL×MAM-B-2S6-CL (6 Ports Type / Plate size : Small)

• Application (Thread): R 1/4 Mass: 500 g (Plug), 788 g (Socket)

Dimensions (mm)

Plate without CUPLA **MAM-B Type**

**6**  
Ports

Applicable CUPLA  
(See page 123 to 124)

Plug	Socket
MAM-A-2P	MAM-A-2S
MAM-A-ZEL-2P	MAM-A-ZEL-2S

Plate model of Socket side  
**MAM-B-2S6-CL**

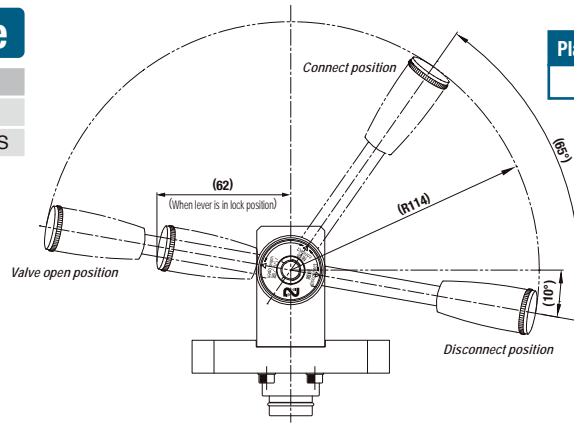
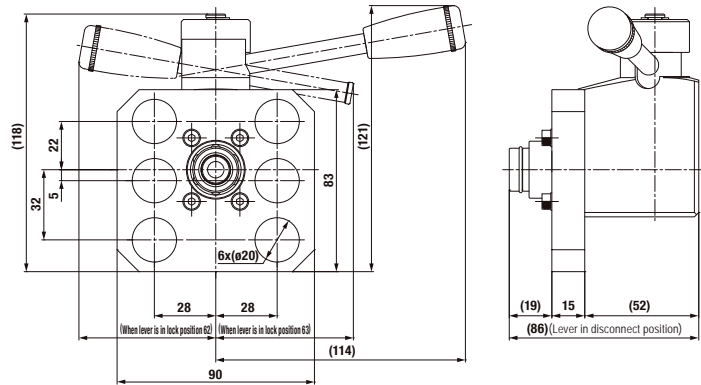
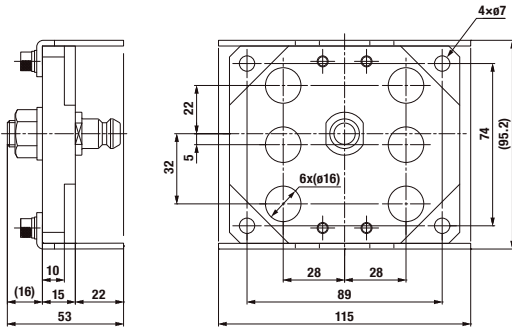

Plate model of Plug side  
**MAM-B-2P6-CL**



Model MAM-B-2P8-CL×MAM-B-2S8-CL (8 Ports Type / Plate size : Large)

• Application (Thread): R 1/4 Mass: 600 g (Plug), 894 g (Socket)

Dimensions (mm)

Plate without CUPLA **MAM-B Type**

**8**  
Ports

Applicable CUPLA  
(See page 123 to 124)

Plug	Socket
MAM-A-2P	MAM-A-2S
MAM-A-ZEL-2P	MAM-A-ZEL-2S

Plate model of Socket side  
**MAM-B-2S8-CL**

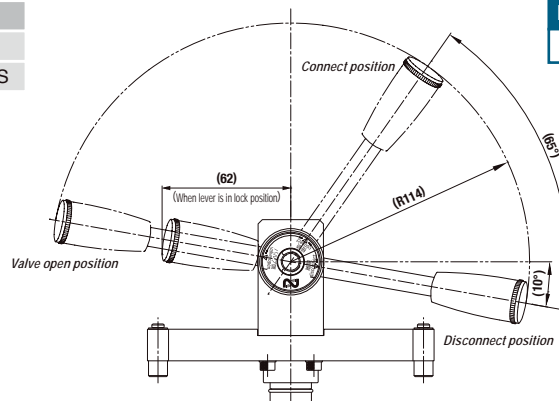
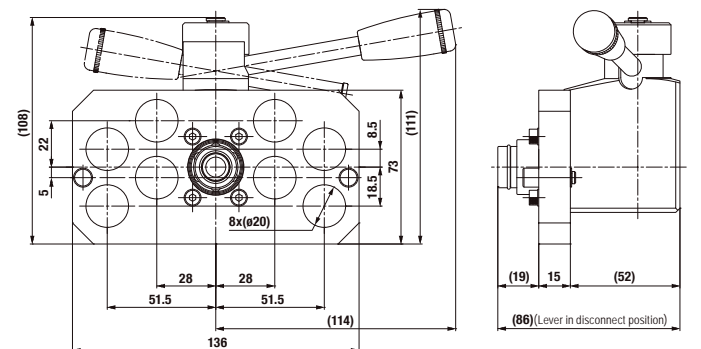
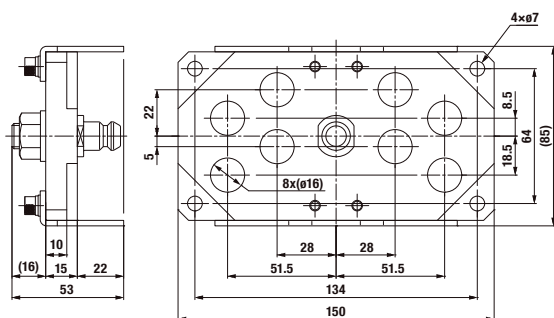

Plate model of Plug side  
**MAM-B-2P8-CL**



Made-to-order MULTI CUPLA is available on request, such as a combination of different sizes on the flange plate.

Models and Dimensions

Model MAM-A-2P6-CL×MAM-A-2S6-CL (6 Ports Type / Plate size : Small)

• Application (Thread): R 1/4 Mass: 860 g (Plug), 1658 g (Socket)

Dimensions (mm)

Plate without CUPLA **MAM-A Type**

**6**  
Ports

Applicable CUPLA  
(See page 123 to 124)

Plug	Socket
MAM-A-2P	MAM-A-2S
MAM-A-ZEL-2P	MAM-A-ZEL-2S

Plate model of Plug side  
**MAM-A-2P6-CL**

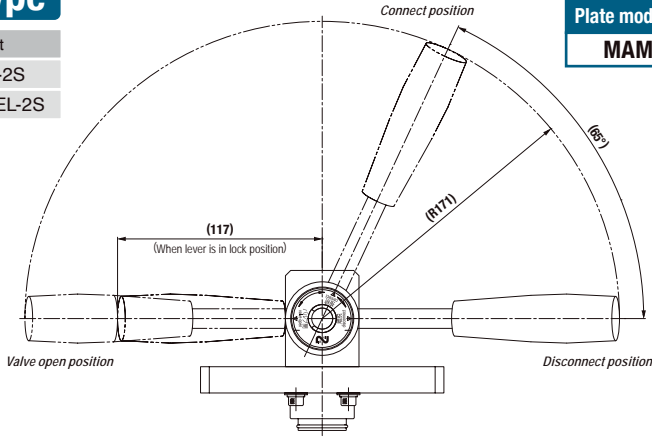
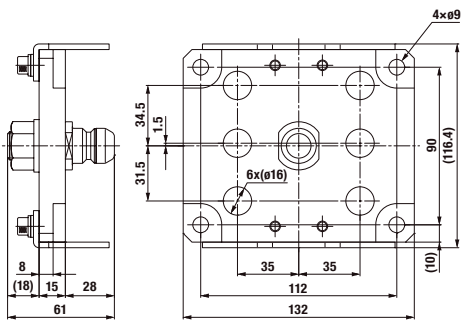
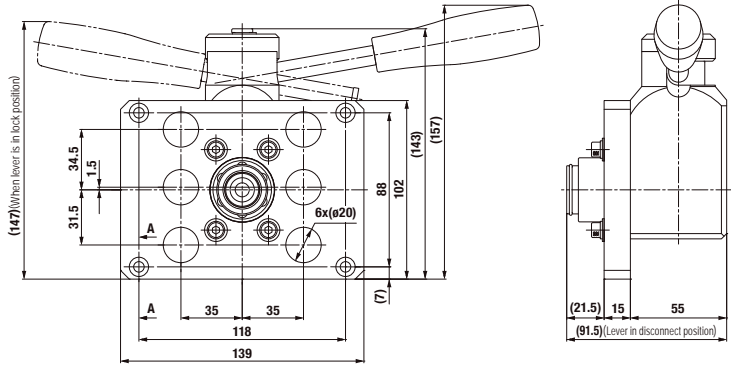

Plate model of Socket side  
**MAM-A-2S6-CL**



Model MAM-A-2P12-CL×MAM-A-2S12-CL (12 Ports Type / Plate size : Large)

• Application (Thread): R 1/4 Mass: 1170 g (Plug), 1816 g (Socket)

Dimensions (mm)

Plate without CUPLA **MAM-A Type**

**12**  
Ports

Applicable CUPLA  
(See page 123 to 124)

Plug	Socket
MAM-A-2P	MAM-A-2S
MAM-A-ZEL-2P	MAM-A-ZEL-2S

Plate model of Plug side  
**MAM-A-2P12-CL**

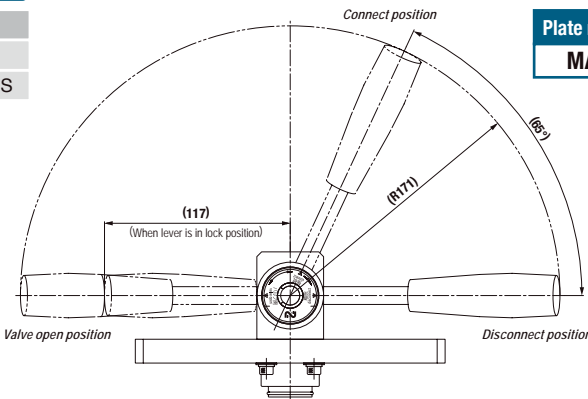
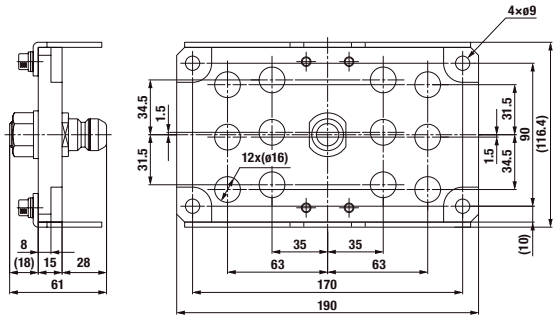
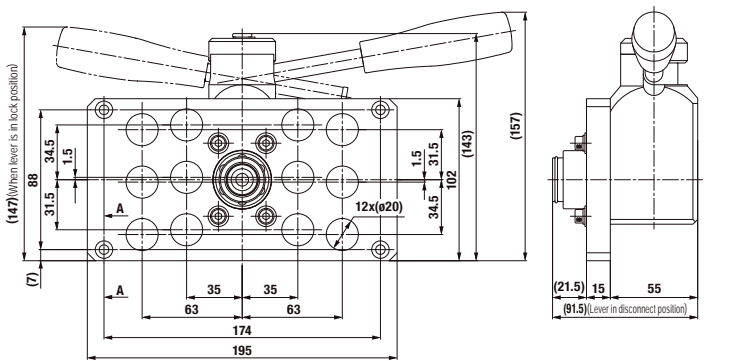

Plate model of Socket side  
**MAM-A-2S12-CL**



Made-to-order MULTI CUPLA is available on request, such as a combination of different sizes on the flange plate.

Before use, please be sure to read "Safety Guide" described at the end of this book and "Instruction Sheet" that comes with the products.

Models and Dimensions

Model MAM-A-3P6-CL×MAM-A-3S6-CL (6 Ports Type / Plate size : Small)

• Application (Thread): R 3/8 Mass: 878 g (Plug), 1668 g (Socket)

Dimensions (mm)

Plate without CUPLA **MAM-A Type**

**6**  
Ports

Applicable CUPLA  
(See page 123 to 124)

Plug	Socket
MAM-A-3P	MAM-A-3S
MAM-A-ZEL-3P	MAM-A-ZEL-3S

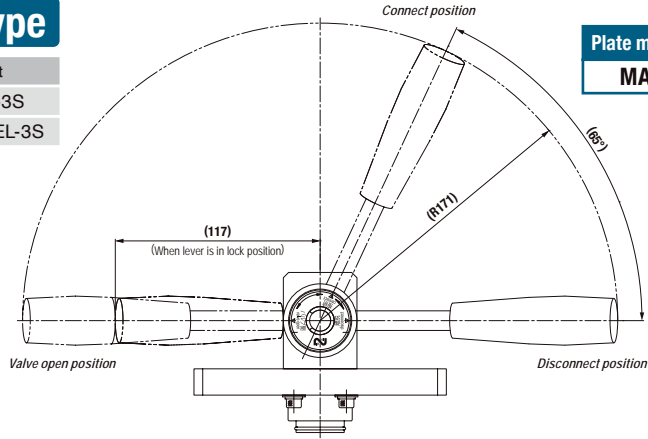

Plate model of Socket side  
**MAM-A-3S6-CL**

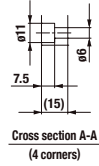
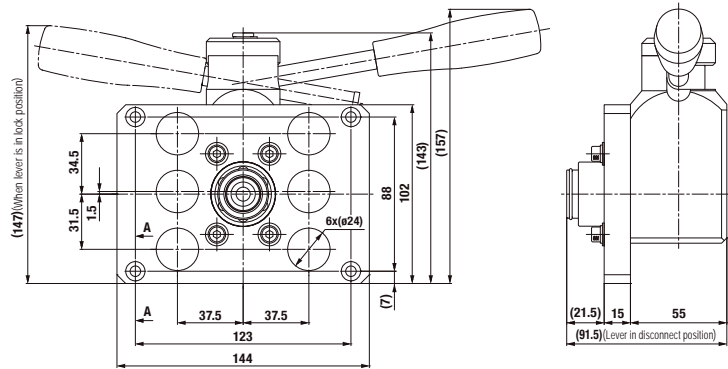
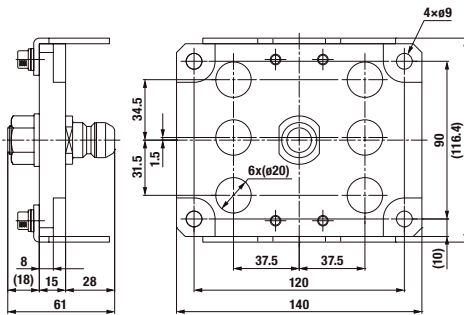

Plate model of Plug side  
**MAM-A-3P6-CL**



Model MAM-A-3P12-CL×MAM-A-3S12-CL (12 Ports Type / Plate size : Large)

• Application (Thread): R 3/8 Mass: 1206 g (Plug), 1836 g (Socket)

Dimensions (mm)

Plate without CUPLA **MAM-A Type**

**12**  
Ports

Applicable CUPLA  
(See page 123 to 124)

Plug	Socket
MAM-A-3P	MAM-A-3S
MAM-A-ZEL-3P	MAM-A-ZEL-3S

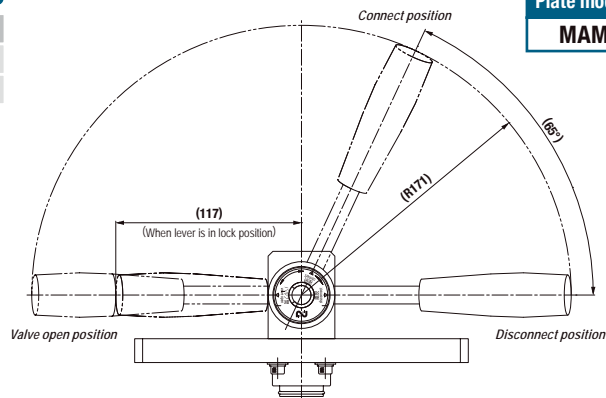

Plate model of Socket side  
**MAM-A-3S12-CL**

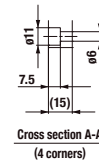
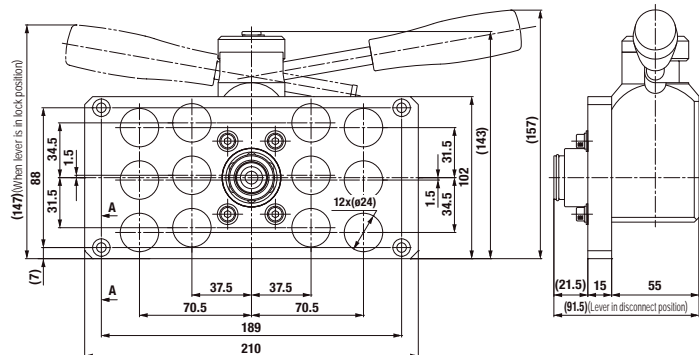
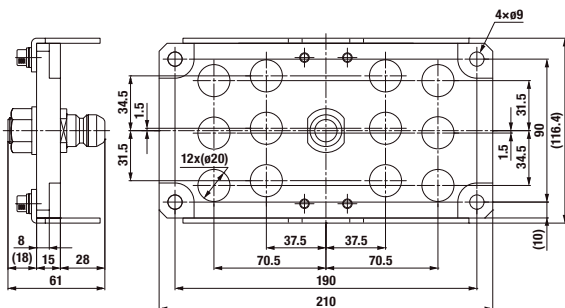

Plate model of Plug side  
**MAM-A-3P12-CL**



Made-to-order MULTI CUPLA is available on request, such as a combination of different sizes on the flange plate.

Models and Dimensions

Model MAM-A-4P4-CL×MAM-A-4S4-CL (4 Ports Type / Plate size : Small)

• Application (Thread): R 1/2 Mass: 892 g (Plug), 1676 g (Socket)

Dimensions (mm)

Plate without CUPLA MAM-A Type

<b>4</b> Ports	Applicable CUPLA (See page 123 to 124)	Plug	Socket
		MAM-A-4P	MAM-A-4S
		MAM-A-ZEL-4P	MAM-A-ZEL-4S

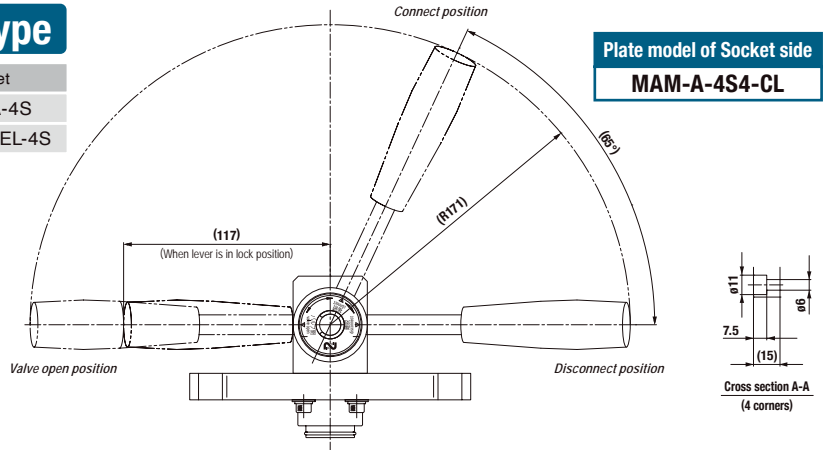
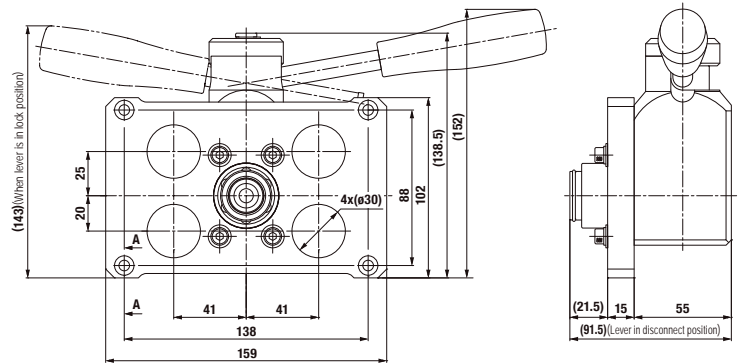
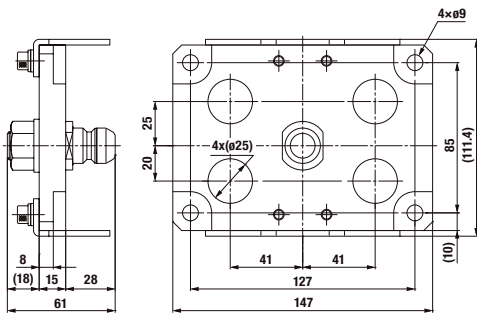

Plate model of Plug side MAM-A-4P4-CL



Model MAM-A-4P8-CL×MAM-A-4S8-CL (8 Ports Type / Plate size : Large)

• Application (Thread): R 1/2 Mass: 1284 g (Plug), 1952 g (Socket)

Dimensions (mm)

Plate without CUPLA MAM-A Type

<b>8</b> Ports	Applicable CUPLA (See page 123 to 124)	Plug	Socket
		MAM-A-4P	MAM-A-4S
		MAM-A-ZEL-4P	MAM-A-ZEL-4S

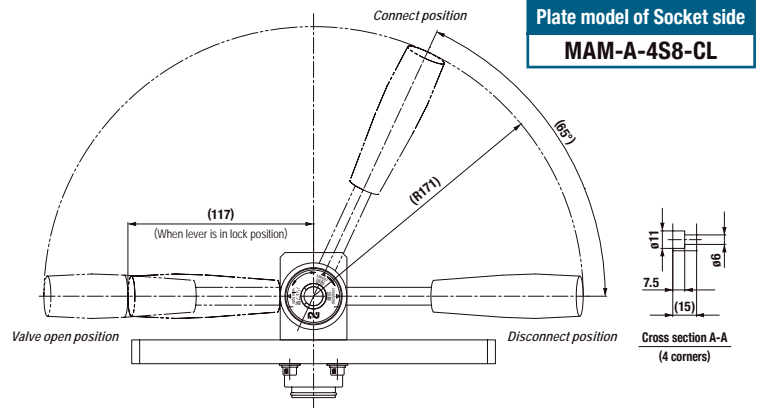
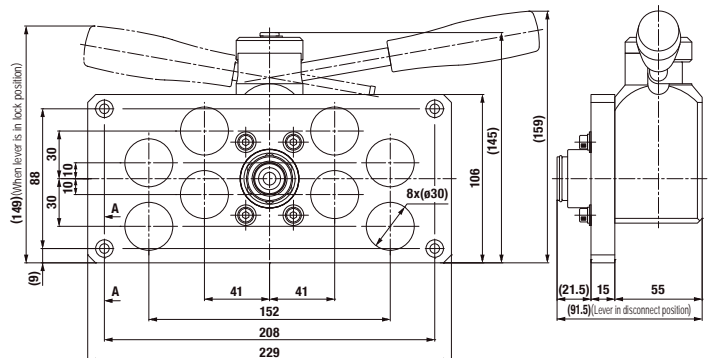
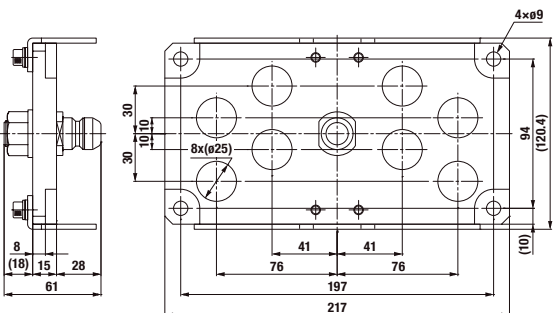

Plate model of Plug side MAM-A-4P8-CL



Made-to-order MULTI CUPLA is available on request, such as a combination of different sizes on the flange plate.

Before use, please be sure to read "Safety Guide" described at the end of this book and "Instruction Sheet" that comes with the products.



## For Multi-Port Connection (Automatic)

# MULTI CUPLA MAS Type / MAT Type

7.0 MPa {71 kgf/cm<sup>2</sup>} general purpose type

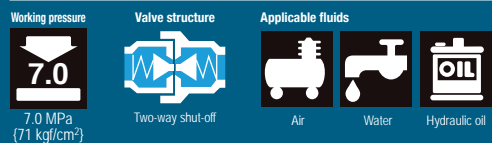

## Connects multiple lines simultaneously with a single operation for different fluids and sizes.

- Effective for automated systems that connect/disconnect multiple lines simultaneously using hydraulic or pneumatic cylinders.
- Automatic shut-off valves in both sockets and plugs ensure no outflow of fluid on disconnection.
- Body materials other than stainless steel are available, which can be ordered with or without valves (made-to-order products).
- Snap ring and screw thread-in types to mount on the base plate are standardized.
- MAS type can accept axial eccentricity between socket and plug. The allowance of eccentricity is within the radius range of 0.3 mm.

\* CUPLA connection or disconnection with fluid under dynamic pressure cannot be made.



Specifications				
Body material	Stainless steel (Nickel plated)			
Pressure unit	MPa	kgf/cm <sup>2</sup>	bar	PSI
Working pressure	7.0	71	70	1020
Seal material	Sealing material	Mark	Working temperature range	
Working temperature range <sup>*1</sup>	Fluoro rubber	FKM	-20°C to +180°C	

\*1: The operable temperature range depends on the operating conditions.

Maximum Tightening Torque					Nm {kgf·cm}				
Size (Thread)	1/4"	3/8"	1/2"	3/4"	1"				
Torque (MAS type)	14 {143}	22 {224}	60 {612}	90 {918}	120 {1224}				
Size (Thread)	M20	M24	M30	M39	M45				
Torque (MAT type)	50 {510}	50 {510}	50 {510}	70 {714}	80 {816}				

### Interchangeability

- MAS & MAT or MAS & MAS types of the same size are to be connected.
- Connection between the same MAT types is virtually not possible because there is no allowance for eccentricity.

Minimum Cross-Sectional Area						(mm <sup>2</sup> )					
Model	2SP	3SP	4SP	6SP	8SP						
Min. cross-sectional area	23	41	76	145	224						

### Suitability for Vacuum

Suitability for Vacuum			1.3×10 <sup>-1</sup> Pa {1×10 <sup>-3</sup> mmHg}		
Socket only	Plug only	When connected			
—	—	Operational			

### Admixture of Air on Connection

May vary depending upon the usage conditions.

Admixture of Air on Connection						(mL)					
Model	2SP	3SP	4SP	6SP	8SP						
Volume of air	1.1	2.4	3.2	10.5	17.0						

### Load Required to Maintain Connection When Line Is Pressurized

Load Required to Maintain Connection When Line Is Pressurized					
Model	2SP	3SP	4SP	6SP	8SP
Maximum acceptable load N (kgf)	3200 {327}	5200 {531}	9200 {939}	13900 {1419}	20200 {2062}
Minimum load required to maintain connection N (kgf) *1	Px185+45 {p×1.85+4.5}	Px310+70 {p×3.1+7}	Px545+85 {p×5.45+8.5}	Px850+95 {p×8.5+9.5}	Px1225+120 {p×12.25+12}

\*1: Assign the actual value of pressure [P (MPa), p (kgf/cm<sup>2</sup>)] to the above formula to calculate the load. Maintain the connection with the minimum load or more, but not more than the maximum acceptable load.

### Flow Rate - Pressure Loss Characteristics

[Test conditions] - Fluid: Water - Temperature: 23°C±5°C

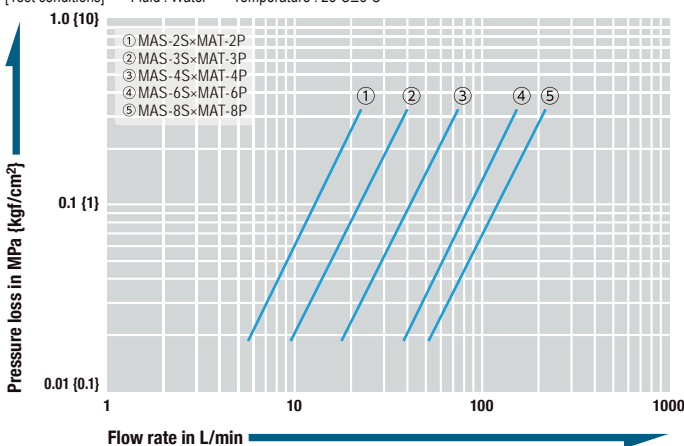

### Application Example

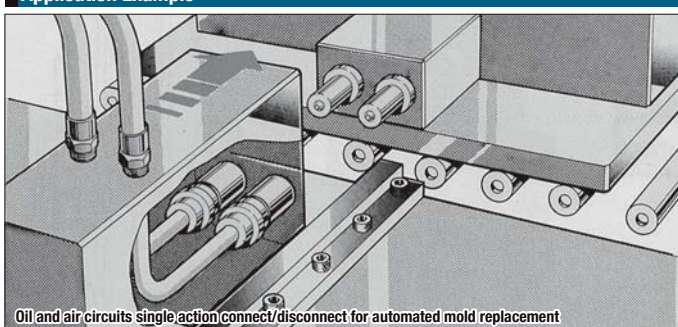

Models and Dimensions

**Plug MAS type (With snap ring)**

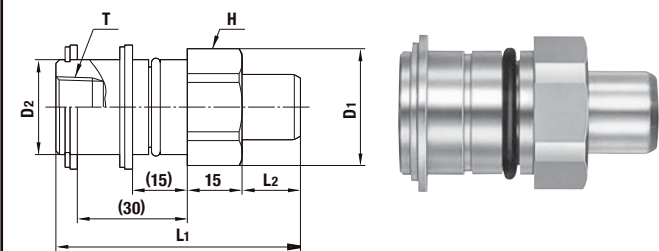

Model	Application (Thread)	Mass (g)	Dimensions (mm)					
			L1	L2	øD1	øD2	H(WAF)	T
MAS-2P	R 1/4	150	65	14	28	21.9	Hex.26	Rc 1/4
MAS-3P	R 3/8	203	67	16	35	25.9	Hex.32	Rc 3/8
MAS-4P	R 1/2	412	73	20	44	35.9	Hex.41	Rc 1/2
MAS-6P	R 3/4	579	76.5	23.5	50	41.9	Hex.46	Rc 3/4
MAS-8P	R 1	720	78	24	58	47.9	Hex.54	Rc 1

**Socket MAS type (With snap ring)**

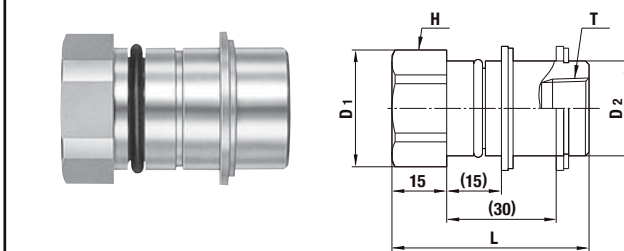

Model	Application (Thread)	Mass (g)	Dimensions (mm)				
			L	øD1	øD2	H(WAF)	T
MAS-2S	R 1/4	126	51.5	28	21.9	Hex.26	Rc 1/4
MAS-3S	R 3/8	171	55	35	25.9	Hex.32	Rc 3/8
MAS-4S	R 1/2	406	65	44	35.9	Hex.41	Rc 1/2
MAS-6S	R 3/4	604	76	50	41.9	Hex.46	Rc 3/4
MAS-8S	R 1	825	87	58	47.9	Hex.54	Rc 1

**Plug MAT type (Thread screw mount)**

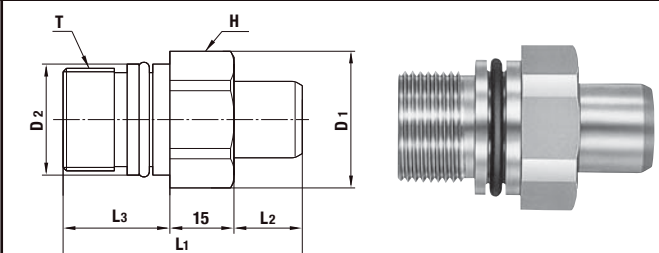

Model	Application (Thread)	Mass (g)	Dimensions (mm)						
			L1	L2	L3	øD1	øD2	H(WAF)	T
MAT-2P	See drawings below.	121	53	14	(24)	28	21.9	Hex.26	M20×1.5
MAT-3P		164	56	16	(25)	32	25.9	Hex.29	M24×1.5
MAT-4P		332	67	20	(32)	44	35.9	Hex.41	M30×2
MAT-6P		453	73	23.5	(34.5)	50	41.9	Hex.46	M39×2
MAT-8P		571	76	24	(37)	54	47.9	Hex.50	M45×2

**Socket MAT type (Thread screw mount)**

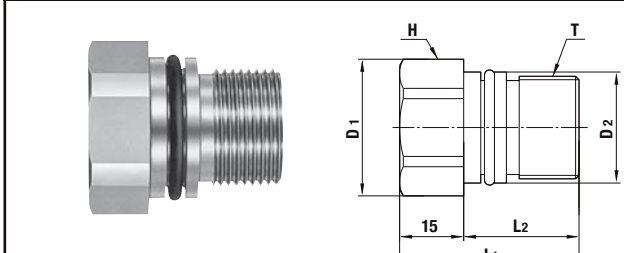

Model	Application (Thread)	Mass (g)	Dimensions (mm)					
			L1	L2	øD1	øD2	H(WAF)	T
MAT-2S	See drawings below.	95	39	(24)	28	21.9	Hex.26	M20×1.5
MAT-3S		124	42	(27)	32	25.9	Hex.29	M24×1.5
MAT-4S		246	48	(33)	44	35.9	Hex.41	M30×2
MAT-6S		382	58	(43)	50	41.9	Hex.46	M39×2
MAT-8S		506	66	(51)	54	47.9	Hex.50	M45×2

• MAT type must be coupled with MAS type.

Dimensions for Mounting

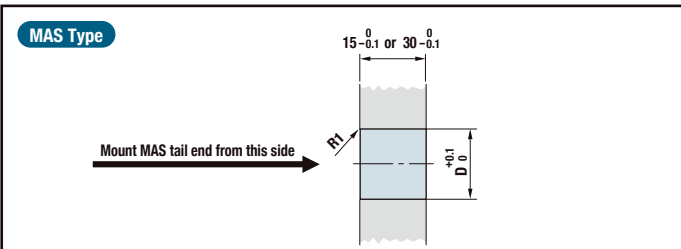

Model	Dimensions (mm)	
	øD	
MAS-2S / MAS-2P	23	
MAS-3S / MAS-3P	27	
MAS-4S / MAS-4P	37	
MAS-6S / MAS-6P	43	
MAS-8S / MAS-8P	49	

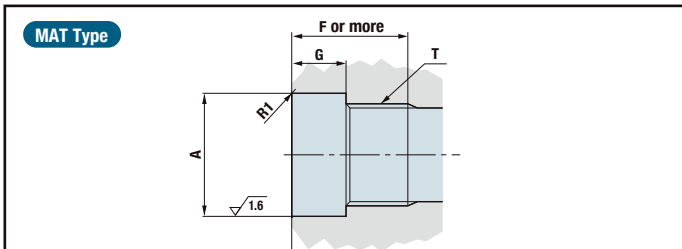

Model	Dimensions (mm)				
	øA	G	F		T
			Plug	Socket	
MAT-2S / MAT-2P	22 <sup>+0.06</sup> <sub>0</sub>	13	25		M20×1.5
MAT-3S / MAT-3P	26 <sup>+0.06</sup> <sub>0</sub>	13	26	28	M24×1.5
MAT-4S / MAT-4P	36 <sup>+0.08</sup> <sub>0</sub>	16	34	35	M30×2
MAT-6S / MAT-6P	42 <sup>+0.08</sup> <sub>0</sub>	17	36.5	45	M39×2
MAT-8S / MAT-8P	48 <sup>+0.08</sup> <sub>0</sub>	17	39	53	M45×2

For Multi-Port Connection (Automatic)

# MULTI CUPLA MALC-01 Type for Low Pressure Use

One-way shut-off type for Low pressure use

Working pressure <b>1.0</b> 1.0 MPa (10 kgf/cm <sup>2</sup> )	Valve structure  One-way shut-off	Applicable fluids  Air Water
--	---	------------------------------------

**Solo use of socket is possible.  
Suitable for operation of ejector  
pins to open/close valve gates  
in molding.**

- Solo use of socket is possible.
- As in the case of MULTI CUPLA MALC-SP type and MALC-HSP type, the distance between the socket plate and the plug plate is designed to be 30 mm when connected. This means MULTI CUPLA MALC-01 type can also be installed mixed with any size of MALC-SP type and MALC-HSP type on the same plate.
- An axial eccentricity allowance of 2 mm eliminates precise centering at installation.
- Compact size with " thread screw mount " and "with flange" types available.



Specifications				
Body material	Socket: Brass (Nickel plated) Plug: Brass (Nickel plated)			
Pressure unit	MPa	kgf/cm <sup>2</sup>	bar	PSI
Working pressure	1.0	10	10	145
Seal material	Sealing material		Mark	Working temperature range
Working temperature range *1	Nitrile rubber		NBR	-20°C to +80°C

\*1: The operable temperature range depends on the operating conditions.

Maximum Tightening Torque		Nm {kgf·cm}
Thread screw mount	15 {153}	
Flange	1.5 {15}	

**Interchangeability**

- Sockets and plugs can be connected regardless of end configurations.
- Not interchangeable with MALC-SP Type (for medium pressure use) MALC-1SP or MALC-HSP Type (for high pressure use) MALC-1HSP.

Minimum Cross-Sectional Area		(mm <sup>2</sup> )
Minimum cross-sectional area	28	

**Suitability for Vacuum**  
Not suitable for vacuum application in either connected or disconnected condition.

**Load Required to Maintain Connection When Line Is Pressurized**

$$F = (P \times 160) + 50 \{ f = p \times 1.6 + 5 \}$$

Minimum load required to maintain connection F [N] {f [kgf]}  
Actual value of pressure P [MPa] {p [kgf/cm<sup>2</sup>]}

Assign the actual value of pressure [P (MPa), p (kgf/cm<sup>2</sup>)] to the above formula.  
Maintain the connection with this load [F (N), f (kgf)] or more.  
However, the maximum acceptable load is 500 N {51 kgf}.

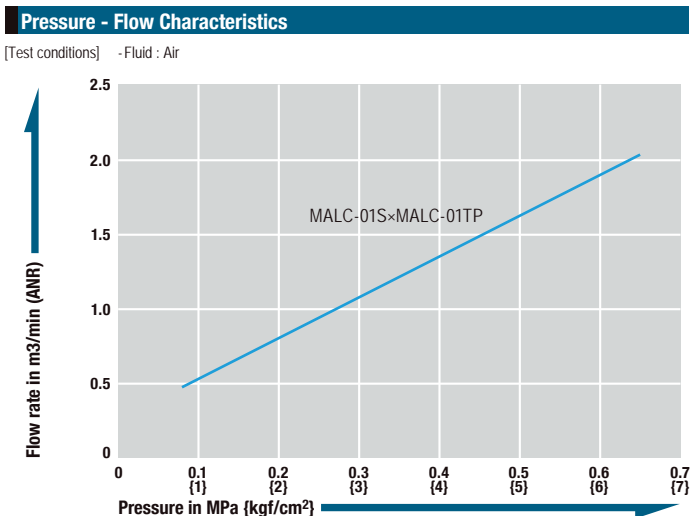

**Acceptable distance between CUPLA**

Socket and plug or plate must be used in contact with each other. Maximum 0.5 mm distance between socket and plug or plate is acceptable.

Models and Dimensions

**Plug MALC-01TP type (Thread screw mount)**

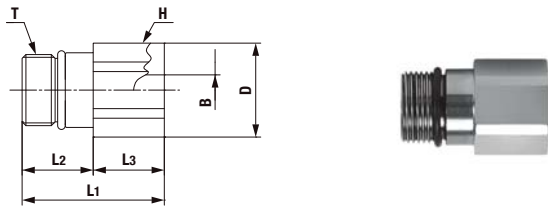

Model	Application	Mass (g)	Dimensions (mm)						
			L1	L2	L3	øD	øB	H(WAF)	T
MALC-01TP	See drawings below.	40	28	(14)	14	18.5	6	Hex.17	M14×1

**Socket MALC-01S type (Thread screw mount)**

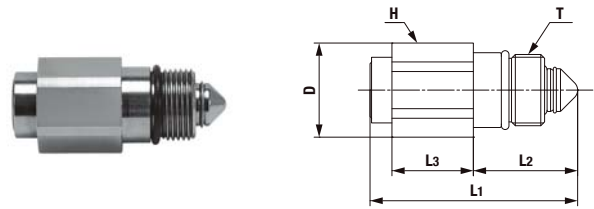

Model	Application	Mass (g)	Dimensions (mm)					T
			L1	L2	L3	øD	H(WAF)	
MALC-01S	See drawings below.	39	(41)	(20.5)	16	18.5	Hex.17	M14×1

**Plug MALC-01TP-FL type (With flange)**

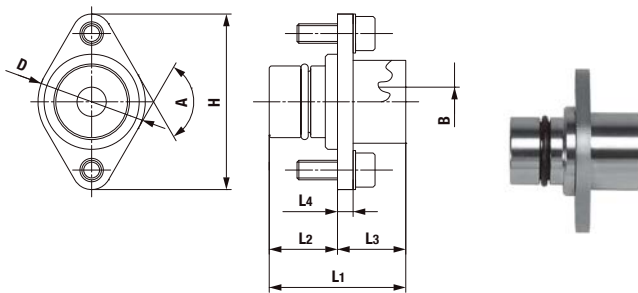

Model	Application	Mass (g)	Dimensions (mm)							
			L1	L2	L3	L4	øD	A	øB	H
MALC-01TP-FL	See drawings below.	52	28	(14)	14	3.2	(22)	120°	6	36

**Socket MALC-01S-FL type (With flange)**

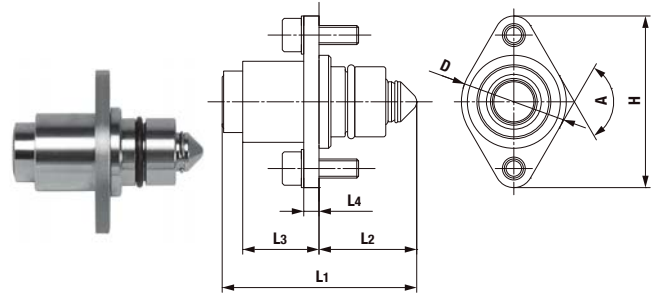

Model	Application	Mass (g)	Dimensions (mm)						
			L1	L2	L3	L4	øD	A	H
MALC-01S-FL	See drawings below.	51	(41)	(20.5)	16	3.2	(22)	120°	36

Dimensions for Mounting

**MALC-01TP / 01S type (Thread screw mount)**

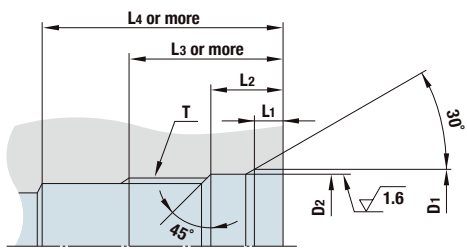

Model	Dimensions (mm)						
	øD1	øD2	L1	L2	L3	L4	T
MALC-01S	15.8 <sup>+0.05</sup> <sub>0</sub>	14.8 <sup>+0.05</sup> <sub>0</sub>	3	7.5 <sup>+0.2</sup> <sub>0</sub>	16	25	M14×1
MALC-01TP						18	

**MALC-01TP-FL / 01S-FL type (With flange)**

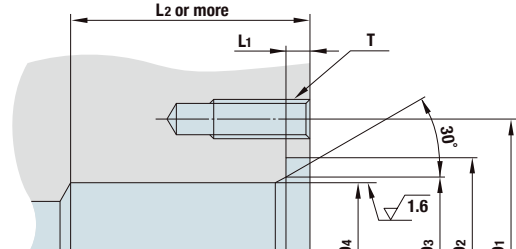

Model	Dimensions (mm)						
	D1	øD2	øD3	øD4	L1	L2	T
MALC-01S-FL	PCD28	20	16	14.8 <sup>+0.05</sup> <sub>0</sub>	2.5 <sup>+0.1</sup> <sub>0</sub>	25	2×M4×0.7 Thread depth 10 mm or more
MALC-01TP-FL						16	

Solo use of socket is possible

The shape of counterpart for solo use of socket

The shape of counterpart for connection

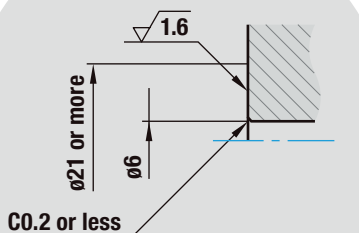

The angle of inclination between the socket and counterpart must be within 0.5 degrees.

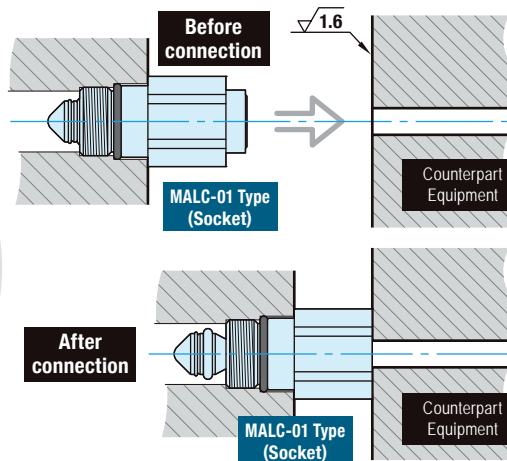

Distance between plates is 16 mm for solo use of socket.

As in the case of MULTI CUPLA MALC-SP type and MALC-HSP type, the distance between the socket plate and the plug plate is designed to be 30 mm when connected. This means MULTI CUPLA MALC-01 type can also be installed mixed with any size of MALC-SP type and MALC-HSP type on the same plate.

A 2 mm axial eccentricity allowance.

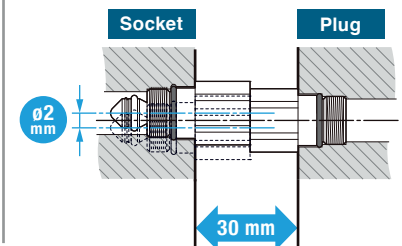



For Multi-Port Connection (Automatic)

# MULTI CUPLA

## MALC-SP Type for Medium Pressure Use

Low spill type for medium pressure use

<b>Working pressure</b>	<b>Valve structure</b>	<b>Applicable fluids</b>		
1.5 to 7.0 MPa (15 to 71 kgf/cm²)	Two-way shut-off (Spill Reduction)	Water	Hydraulic oil	Air

A single operation enables simultaneous connections of multiple lines. A special design for medium pressure use minimizes air admixture in fluid lines upon connection.

- Compared with conventional MULTI CUPLA, approximately double flow rates are realized. This could reduce the size of required plates. (Rate of flow increase depends on CUPLA sizes.)
- The MALC type realizes a 2 mm axial eccentricity allowance, while conventional MULTI CUPLA is only 0.6 mm.
- Special valve design enables connection of socket and plug under pressure of up to 2 MPa. (up to 1.5 MPa for MALC-12SP.)
- When connected, the distance between the socket plate and the plug plate is designed to be 30 mm for all sizes. This means that any size of CUPLA can be mounted and used on the same plate.
- Low spill valves minimize outflow of fluid and admixture of air into the fluid line.



Specifications				
Body material		Stainless steel (Socket body: Nickel plated)		
Model	Thread screw mount	MALC-1SP	MALC-2 to 8SP	MALC-12SP
	Flange	-	MALC-2 to 8SP-FL	-
	Snap ring	-	MALC-8SP-10F	MALC-12SP-(F/-16F)
Working pressure (Individual unit)	MPa	7.0 (2.0)	5.0 (2.0)	1.5 (1.5)
	kgf/cm <sup>2</sup>	71 (20)	51 (20)	15 (15)
	bar	70 (20)	50 (20)	15 (15)
	PSI	1020 (290)	725 (290)	218 (218)
Seal material		Sealing material	Mark	Working temperature range
Working temperature range <sup>1)</sup>		Fluoro rubber	FKM	-20°C to +180°C

<sup>1)</sup> The operable temperature range depends on the operating conditions.

Maximum Tightening Torque		Nm {kgf·cm}							
Model		1SP	2SP	3SP	4SP	6SP	8SP	12SP	12SP-16F
Thread screw mount		20 {204}	30 {306}	35 {357}	45 {460}	60 {612}	75 {765}	80 {816}	-
Flange		-	7 {71.5}	7 {71.5}	7 {71.5}	7 {71.5}	23 {235}	-	-
Snap ring		-	-	-	-	-	260 {2652}	280 {2856}	350 {3570}

**Interchangeability**  
Socket and plug in the same size can be connected regardless of their end configurations.

Minimum Cross-Sectional Area		(mm <sup>2</sup> )						
Model		1SP	2SP(-FL)	3SP(-FL)	4SP(-FL)	6SP(-FL)	8SP(-FL/-10F)	12SP(-F/-16F)
Min. cross-sectional area		26	49.5	87	153	227	347	795

**Suitability for Vacuum**  
Not suitable for vacuum application in either connected or disconnected condition.

Admixture of Air on Connection		May vary depending upon the usage conditions. (mL)						
Model		1SP	2SP(-FL)	3SP(-FL)	4SP(-FL)	6SP(-FL)	8SP(-FL/-10F)	12SP(-F/-16F)
Volume of air		0.08	0.14	0.26	0.55	0.95	0.85	1.46

Volume of Spillage per Disconnection		May vary depending upon the usage conditions. (mL)						
Model		1SP	2SP(-FL)	3SP(-FL)	4SP(-FL)	6SP(-FL)	8SP(-FL/-10F)	12SP(-F/-16F)
Volume of spillage		0.08	0.14	0.26	0.55	0.95	0.85	1.46

Load Required to Maintain Connection When Line Is Pressurized								
Model		1SP	2SP(-FL)	3SP(-FL)	4SP(-FL)	6SP(-FL)	8SP(-FL/-10F)	12SP(-F/-16F)
Maximum acceptable load N (kgf)		2800 {286}	4500 {459}	5600 {571}	10000 {1019}	14000 {1427}	15600 {1591}	8200 {837}
Minimum load required to maintain connection N (kgf) <sup>*1</sup>		P×170+85 {p×1.7+8.5}	P×345+180 {p×3.45+18}	P×460+190 {p×4.6+19}	P×855+260 {p×8.55+26}	P×1160+260 {p×11.6+26}	P×1360+310 {p×13.6+31}	P×2260+400 {p×22.6+40}

<sup>\*1</sup> Assign the actual value of pressure [P (MPa), p (kgf/cm<sup>2</sup>)] to the above formula to calculate the load. Maintain the connection with the minimum load or more, but not more than the maximum acceptable load.

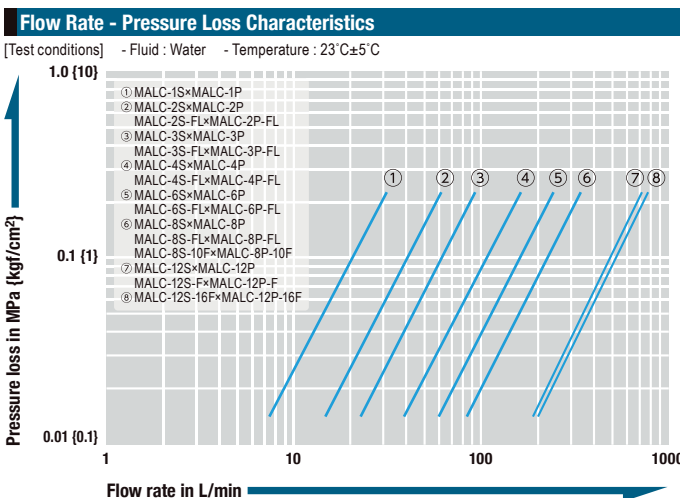



Models and Dimensions

**Plug** MALC-1 to 12P type (Thread screw mount)

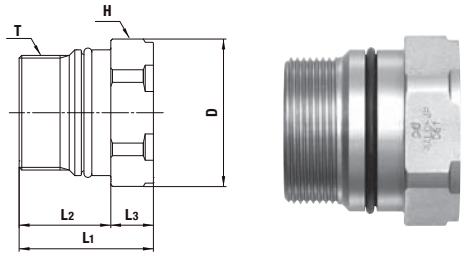

Model	Application	Mass (g)	Dimensions (mm)					
			L1	L2	L3	øD	H(WAF)	T
MALC-1P	See page 137	40	32	(18)	14	21	Hex.19	M16×1
MALC-2P		75	33	(20)	13	28	Hex.26	M20×1.5
MALC-3P		95	33	(20)	13	32	Hex.29	M24×1.5
MALC-4P		248	41	(28)	13	45	Hex.41	M35×1.5
MALC-6P		369	50.5	(37.5)	13	50	Hex.46	M40×2
MALC-8P		399	53	(41)	12	54	Hex.50	M45×2
MALC-12P		724	57	(45)	12	74	Hex.67	M62×2

**Socket** MALC-1 to 12S type (Thread screw mount)

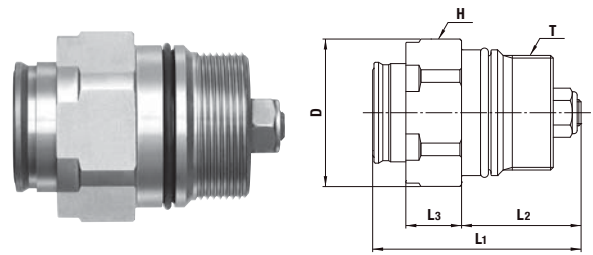

Model	Application	Mass (g)	Dimensions (mm)					
			L1	L2	L3	øD	H(WAF)	T
MALC-1S	See page 137	53	(45)	(23)	16	21	Hex.19	M16×1
MALC-2S		95	(49)	(26)	17	28	Hex.26	M20×1.5
MALC-3S		120	(51)	(26)	17	32	Hex.29	M24×1.5
MALC-4S		306	(64)	(36.5)	17	45	Hex.41	M35×1.5
MALC-6S		471	(78.5)	(47.5)	17	50	Hex.46	M40×2
MALC-8S		590	(86)	(53)	18	54	Hex.50	M45×2
MALC-12S		1176	(98)	(60)	18	74	Hex.67	M62×2

**Plug** MALC-2 to 6P-FL type (With flange)

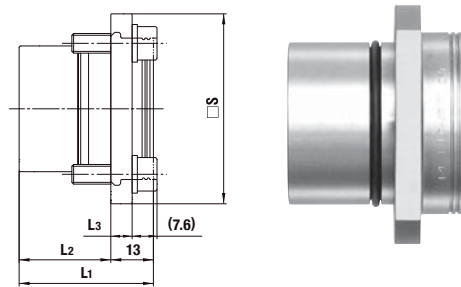

Model	Application	Mass (g)	Dimensions (mm)			
			L1	L2	L3	□ S
MALC-2P-FL	See page 137	146	30	(17)	6	40
MALC-3P-FL		180	33	(20)	6	45
MALC-4P-FL		390	41	(28)	6.5	58
MALC-6P-FL		553	50.5	(37.5)	6.5	64

**Socket** MALC-2 to 6S-FL type (With flange)

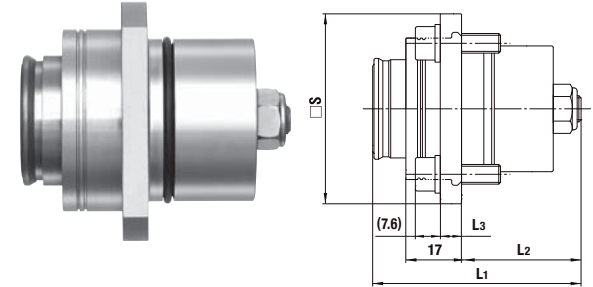

Model	Application	Mass (g)	Dimensions (mm)			
			L1	L2	L3	□ S
MALC-2S-FL	See page 137	173	(49)	(26)	6	40
MALC-3S-FL		208	(51)	(26)	6	45
MALC-4S-FL		449	(64)	(36.5)	6.5	58
MALC-6S-FL		663	(78.5)	(47.5)	6.5	64

**Plug** MALC-8P-FL type (With flange)

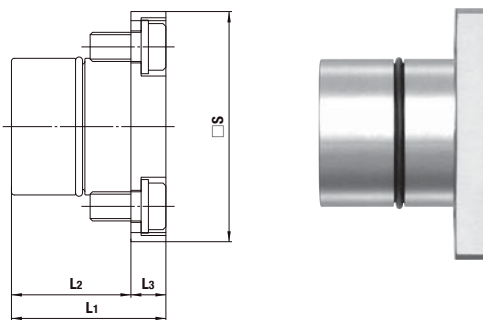

Model	Application	Mass (g)	Dimensions (mm)			
			L1	L2	L3	□ S
MALC-8P-FL	See page 137	796	53	(41)	12	79

**Socket** MALC-8S-FL type (With flange)

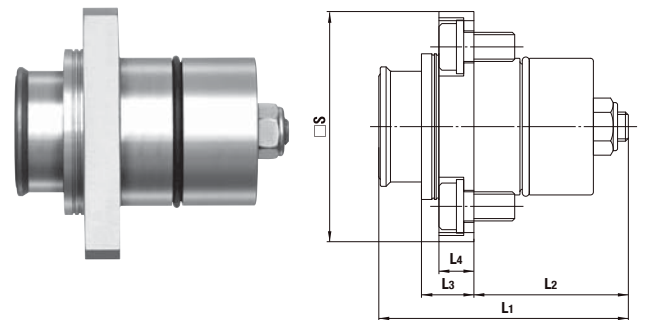

Model	Application	Mass (g)	Dimensions (mm)				
			L1	L2	L3	L4	□ S
MALC-8S-FL	See page 137	978	(86)	(53)	18	12	79

Acceptable distance between socket and plug

Plug and socket must be used in contact with each other. Maximum 0.5 mm distance between socket and plug is acceptable.

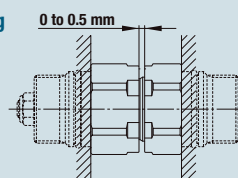

Models and Dimensions

**Plug MALC-8 / 12P type (With snap ring)**

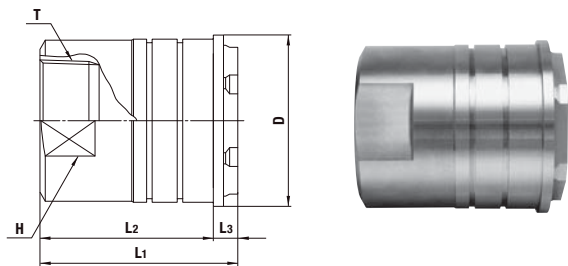

Model	Application	Mass (g)	Dimensions (mm)					
			L1	L2	L3	øD	H(WAF)	T
MALC-8P-10F	See drawings below.	1182	(87)	75	(12)	64	54	Rc 1 1/4
MALC-12P-F		2054	(97)	85	(12)	84	58	Rc 1 1/2
MALC-12P-16F		2128	(97)	85	(12)	84	71	Rc 2

**Socket MALC-8 / 12S type (With snap ring)**

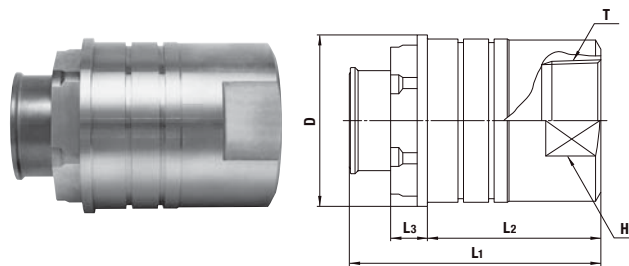

Model	Application	Mass (g)	Dimensions (mm)					
			L1	L2	L3	øD	H(WAF)	T
MALC-8S-10F	See drawings below.	1373	(108)	75	(18)	64	54	Rc 1 1/4
MALC-12S-F		2505	(123)	85	(18)	84	58	Rc 1 1/2
MALC-12S-16F		2579	(123)	85	(18)	84	71	Rc 2

Dimensions for Mounting

**MALC-1 to 12SP type (Thread screw mount)**

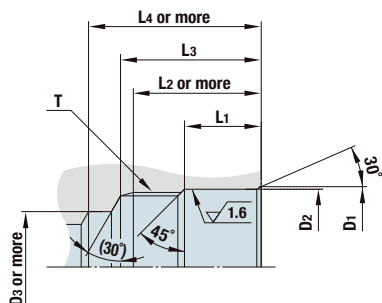

Model	Dimensions (mm)							T
	øD1	øD2	øD3	L1	L2	L3	L4	
MALC-1S	18.3 <sup>+0.1</sup> <sub>0</sub>	17.3 <sup>+0.06</sup> <sub>0</sub>	13	11	20	22	25	M16×1
MALC-1P								
MALC-2S	24 <sup>+0.1</sup> <sub>0</sub>	23 <sup>+0.06</sup> <sub>0</sub>	16	11.5	22	25	28	M20×1.5
MALC-2P								
MALC-3S	27.6 <sup>+0.1</sup> <sub>0</sub>	26.6 <sup>+0.08</sup> <sub>0</sub>	18	11	22	25	29	M24×1.5
MALC-3P								
MALC-4S	39.5 <sup>+0.1</sup> <sub>0</sub>	38.5 <sup>+0.08</sup> <sub>0</sub>	26	15.5	30	33	40.5	M35×1.5
MALC-4P								
MALC-6S	45 <sup>+0.1</sup> <sub>0</sub>	44 <sup>+0.08</sup> <sub>0</sub>	30	20	40	44	51.5	M40×2
MALC-6P								
MALC-8S	48 <sup>+0.3</sup> <sub>0</sub>	47 <sup>+0.08</sup> <sub>0</sub>	35	27	43	47	55	M45×2
MALC-8P								
MALC-12S	66 <sup>+0.3</sup> <sub>0</sub>	64 <sup>+0.1</sup> <sub>0</sub>	45	30	50	54	65	M62×2
MALC-12P								

**MALC-2 to 8SP-FL type (With flange)**

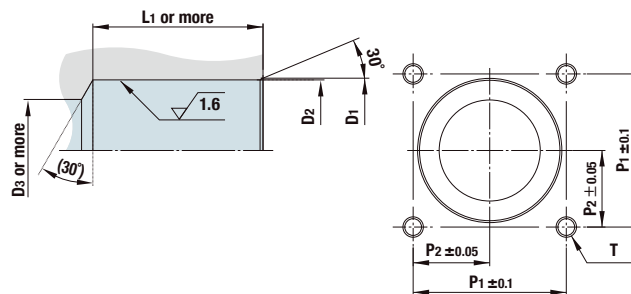

Model	Dimensions (mm)						T
	øD1	øD2	øD3	L1	P1	P2	
MALC-2S-FL	24 <sup>+0.1</sup> <sub>0</sub>	23 <sup>+0.06</sup> <sub>0</sub>	16	28	28	14	4×M6 Thread depth 17 mm or more
MALC-2P-FL				19			
MALC-3S-FL	27.6 <sup>+0.1</sup> <sub>0</sub>	26.6 <sup>+0.08</sup> <sub>0</sub>	18	28	31	15.5	
MALC-3P-FL				22			
MALC-4S-FL	39.5 <sup>+0.1</sup> <sub>0</sub>	38.5 <sup>+0.08</sup> <sub>0</sub>	26	39	40	20	4×M10 Thread depth 15 mm or more
MALC-4P-FL				30.5			
MALC-6S-FL	45 <sup>+0.1</sup> <sub>0</sub>	44 <sup>+0.08</sup> <sub>0</sub>	30	50	45	22.5	
MALC-6P-FL				40			
MALC-8S-FL	48 <sup>+0.3</sup> <sub>0</sub>	47 <sup>+0.08</sup> <sub>0</sub>	35	53	55	27.5	
MALC-8P-FL				43			

**MALC-8 / 12P type (With snap ring)**

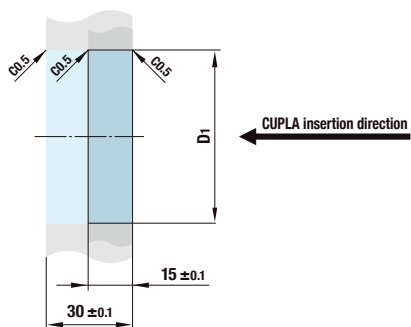
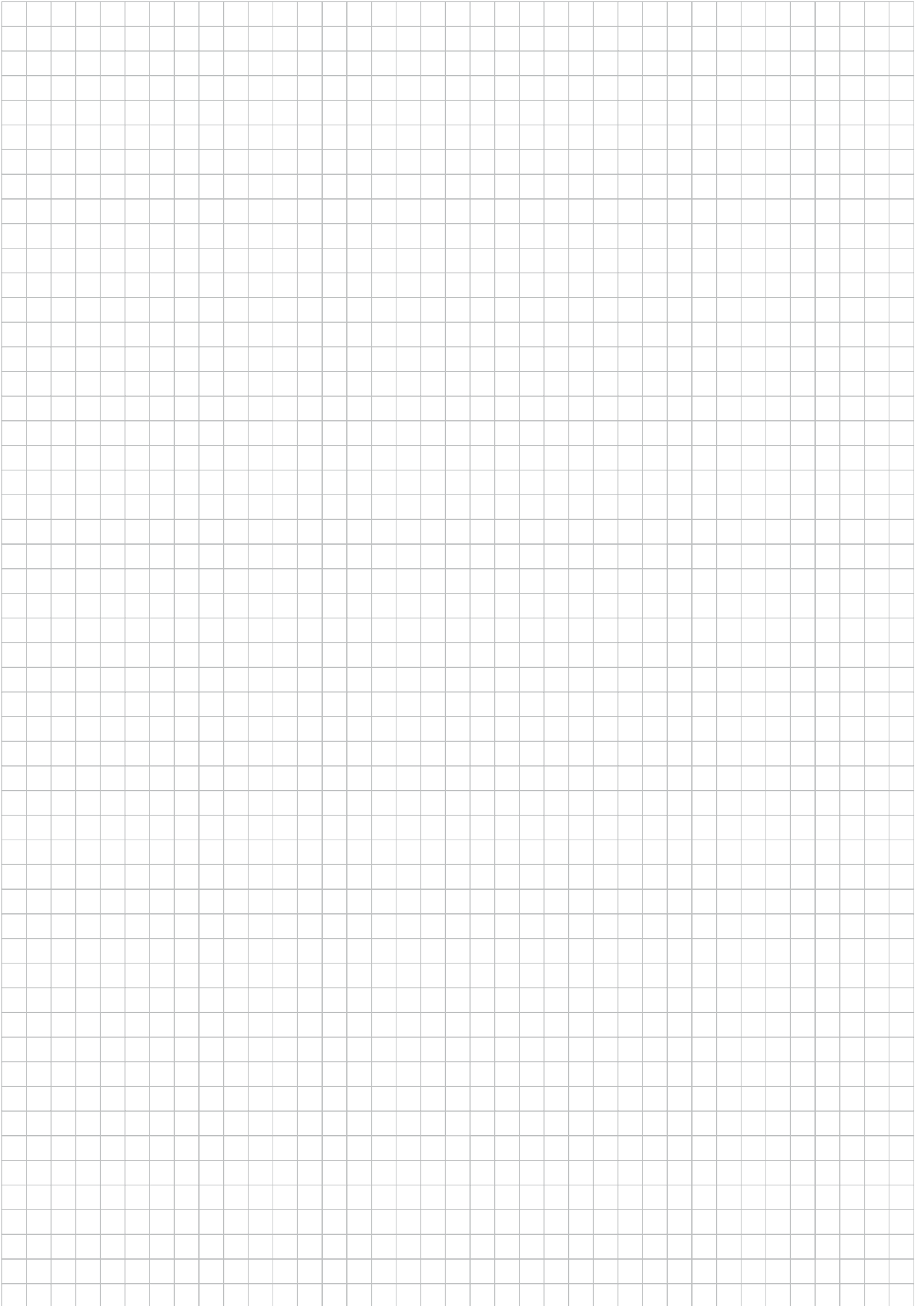

Plate with 15 mm or 30 mm thickness can be mounted.

Model	Dimensions (mm)	
	øD1	
MALC-8S-10F	60.1 <sup>+0.1</sup> <sub>0</sub>	
MALC-8P-10F		
MALC-12S-F	80.1 <sup>+0.1</sup> <sub>0</sub>	
MALC-12P-F		
MALC-12S-16F	80.1 <sup>+0.1</sup> <sub>0</sub>	
MALC-12P-16F		



For Multi-Port Connection (Automatic)

# MULTI CUPLA

## MALC-HSP Type for High Pressure Use

Low spill type for high pressure use

Working pressure



21.0 to 25.0 MPa  
(214 to 255 kgf/cm<sup>2</sup>)

Valve structure



Two-way shut-off  
(Spill Reduction)

Applicable fluids



Hydraulic oil

A single operation enables simultaneous connections of multiple lines. A special design minimizes air admixture in fluid lines upon connection. Suitable for high pressure hydraulic circuits.

- Compared with conventional MULTI CUPLA, approximately double flow rates are realized. This could reduce the size of required plates. (Rate of flow increase depends on CUPLA sizes.)
- The MALC type realizes a 2 mm axial eccentricity allowance, while the conventional MULTI CUPLA is only 0.6 mm.
- Special valve design enables connection of socket and plug under dynamic pressure of up to 8 MPa.
- When connected, the distance between the socket plate and plug plate is designed to be 30 mm for all sizes. This means any size of CUPLA can be mounted and used on the same plate.
- Low spill valves minimize outflow of fluid and admixture of air into the fluid line.



Specifications			
Body material		Special steel (Nickel plated)	
Model	Thread screw mount	MALC-1HSP	MALC-2 to 8HSP
	Flange	-	MALC-2 to 8HSP-FL
Working pressure (Individual unit)	MPa	25.0 (8.0)	21.0 (8.0)
	kgf/cm <sup>2</sup>	255 (81)	214 (81)
	bar	250 (80)	210 (80)
	PSI	3630 (1160)	3050 (1160)
Seal material		Sealing material	Mark
Working temperature range *1		Fluoro rubber	FKM
		Working temperature range	
		-20 °C to +180 °C	

\*1: The operable temperature range depends on the operating conditions.

Maximum Tightening Torque						Nm {kgf·cm}
Model	1HSP	2HSP	3HSP	4HSP	6HSP	8HSP
Thread screw mount	30 {306}	50 {510}	53 {540}	65 {663}	80 {816}	95 {969}
Flange	-	9 {91}				30 {306}

**Interchangeability**  
Socket and plug in the same size can be connected regardless of their end configurations.

Minimum Cross-Sectional Area						(mm <sup>2</sup> )
Model	1HSP	2HSP	3HSP	4HSP	6HSP	8HSP
Min. cross-sectional area	26	49.5	87	153	227	347

**Suitability for Vacuum**  
Not suitable for vacuum application in either connected or disconnected condition.

Admixture of Air on Connection						(mL)
Model	1HSP	2HSP	3HSP	4HSP	6HSP	8HSP
Volume of air	0.08	0.14	0.26	0.55	0.95	0.85

Volume of Spillage per Disconnection						(mL)
Model	1HSP	2HSP	3HSP	4HSP	6HSP	8HSP
Volume of spillage	0.08	0.14	0.26	0.55	0.95	0.85

Load Required to Maintain Connection When Line Is Pressurized						
Model	1HSP	2HSP	3HSP	4HSP	6HSP	8HSP
Maximum acceptable load N (kgf)	9300 {948}	16500 {1683}	22000 {2244}	40500 {4130}	55000 {5609}	64500 {6577}
Minimum load required to maintain connection N (kgf) *1	P×170+85 {p×1.7+8.5}	P×345+180 {p×3.45+18}	P×460+190 {p×4.6+19}	P×855+260 {p×8.55+26}	P×1160+260 {p×11.6+26}	P×1360+310 {p×13.6+31}

\*1: Assign the actual value of pressure [P (MPa), p (kgf/cm<sup>2</sup>)] to the above formula to calculate the load. Maintain the connection with the minimum load or more, but not more than the maximum acceptable load.

### Flow Rate - Pressure Loss Characteristics

[Test conditions] - Fluid : Hydraulic oil - Temperature : 30 °C±5 °C  
- Fluid viscosity : 32×10<sup>-6</sup> m<sup>2</sup>/s - Density : 0.87×10<sup>3</sup> kg/m<sup>3</sup>

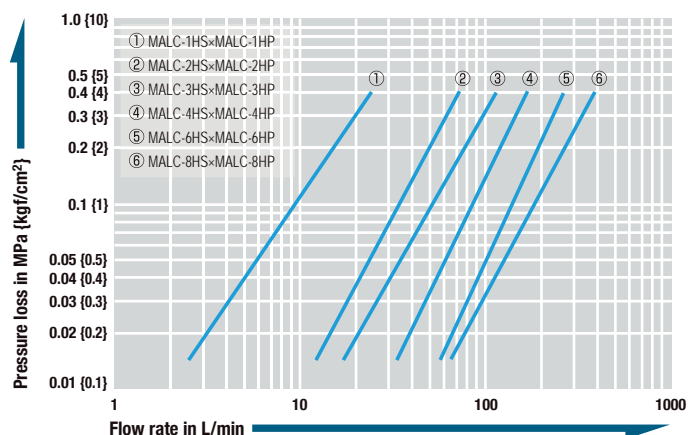

Models and Dimensions

**Plug** MALC-1 to 8HP type (Thread screw mount)

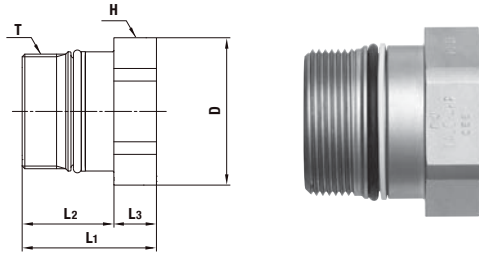

Model	Application	Mass (g)	Dimensions (mm)					
			L1	L2	L3	øD	H(WAF)	T
MALC-1HP	See page 141	39	32	(18)	14	21	Hex.19	M16×1
MALC-2HP		73	33	(20)	13	28	Hex.26	M20×1.5
MALC-3HP		96	33	(20)	13	32	Hex.29	M24×1.5
MALC-4HP		250	41	(28)	13	45	Hex.41	M35×1.5
MALC-6HP		357	50.5	(37.5)	13	50	Hex.46	M40×2
MALC-8HP		391	53	(41)	12	54	Hex.50	M45×2

**Socket** MALC-1 to 8HS type (Thread screw mount)

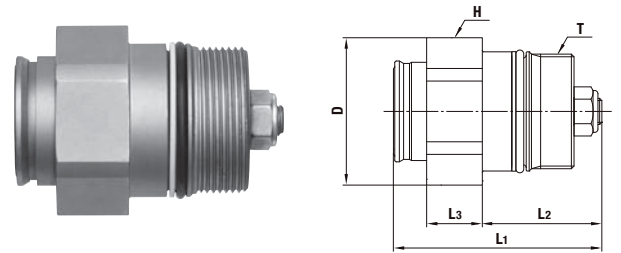

Model	Application	Mass (g)	Dimensions (mm)					
			L1	L2	L3	øD	H(WAF)	T
MALC-1HS	See page 141	51	(45)	(23)	16	21	Hex.19	M16×1
MALC-2HS		89	(49)	(26)	17	28	Hex.26	M20×1.5
MALC-3HS		117	(51)	(26)	17	32	Hex.29	M24×1.5
MALC-4HS		290	(64)	(36.5)	17	45	Hex.41	M35×1.5
MALC-6HS		447	(78.5)	(47.5)	17	50	Hex.46	M40×2
MALC-8HS		579	(86)	(53)	18	54	Hex.50	M45×2

**Plug** MALC-2 to 6HP-FL type (With flange)

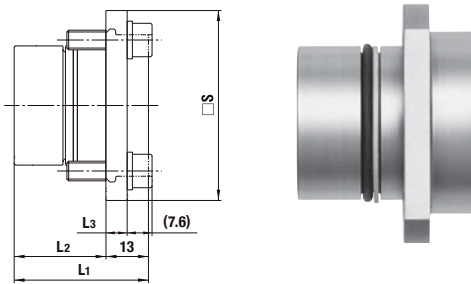

Model	Application	Mass (g)	Dimensions (mm)			
			L1	L2	L3	S
MALC-2HP-FL	See page 141	142	30	(17)	6	40
MALC-3HP-FL		179	33	(20)	6	45
MALC-4HP-FL		367	41	(28)	6.5	58
MALC-6HP-FL		514	50.5	(37.5)	6.5	64

**Socket** MALC-2 to 6HS-FL type (With flange)

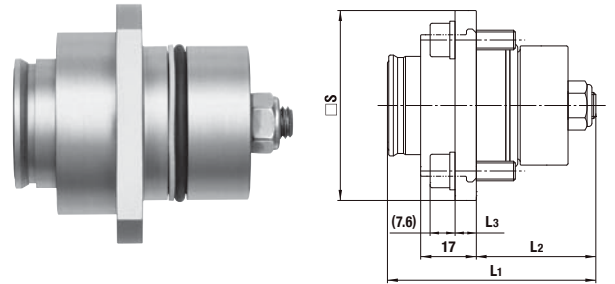

Model	Application	Mass (g)	Dimensions (mm)			
			L1	L2	L3	S
MALC-2HS-FL	See page 141	163	(49)	(26)	6	40
MALC-3HS-FL		200	(51)	(26)	6	45
MALC-4HS-FL		418	(64)	(36.5)	6.5	58
MALC-6HS-FL		611	(78.5)	(47.5)	6.5	64

**Plug** MALC-8HP-FL type (With flange)

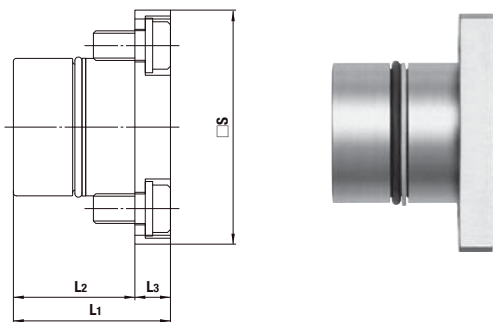

Model	Application	Mass (g)	Dimensions (mm)			
			L1	L2	L3	S
MALC-8HP-FL	See page 141	786	53	(41)	12	79

**Socket** MALC-8HS-FL type (With flange)

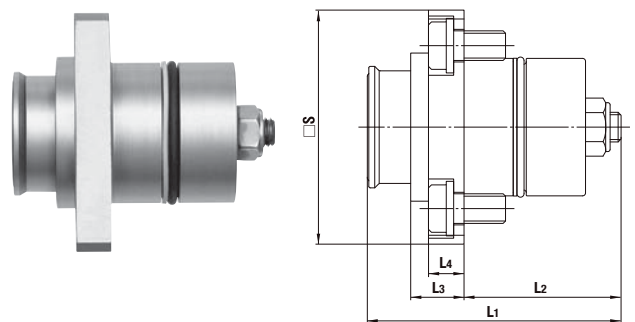

Model	Application	Mass (g)	Dimensions (mm)				
			L1	L2	L3	L4	S
MALC-8HS-FL	See page 141	964	(86)	(53)	18	12	79

Acceptable distance between Socket and Plug

Plug and socket must be used in contact with each other.  
Maximum 0.5 mm distance between socket and plug is acceptable.

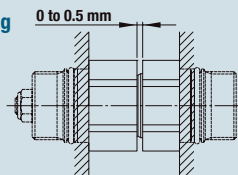



Dimensions for Mounting

MALC-1 to 8HSP type (Thread screw mount)

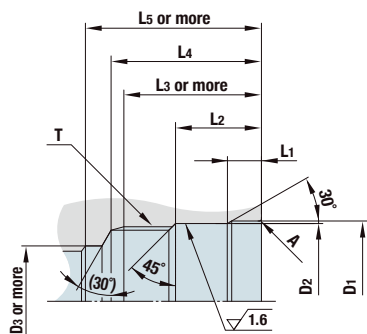

Model	Dimensions (mm)									
	øD1	øD2	øD3	L1	L2	L3	L4	L5	T	A
MALC-1HS	17.8 <sup>+0.1</sup> <sub>0</sub>	16.8 <sup>+0.06</sup> <sub>0</sub>	13	3.5 <sup>+0.2</sup> <sub>0</sub>	11	20	22	25	M16×1	C0.2
MALC-1HP										
MALC-2HS	23 <sup>+0.1</sup> <sub>0</sub>	22 <sup>+0.06</sup> <sub>0</sub>	16	2.8 <sup>+0.2</sup> <sub>0</sub>	11	22	25	28	M20×1.5	R0.5
MALC-2HP										
MALC-3HS	27.1 <sup>+0.1</sup> <sub>0</sub>	26 <sup>+0.08</sup> <sub>0</sub>	18	2.8 <sup>+0.2</sup> <sub>0</sub>	11	22	25	29	M24×1.5	R0.5
MALC-3HP										
MALC-4HS	37.7 <sup>+0.3</sup> <sub>0</sub>	36.5 <sup>+0.08</sup> <sub>0</sub>	26	6 <sup>+0.2</sup>	18	30	33	40.5	M35×1.5	R0.5
MALC-4HP										
MALC-6HS	42.5 <sup>+0.3</sup> <sub>0</sub>	41.5 <sup>+0.08</sup> <sub>0</sub>	30	6 <sup>+0.2</sup>	23	40	44	51.5	M40×2	R0.5
MALC-6HP										
MALC-8HS	47.5 <sup>+0.3</sup> <sub>0</sub>	46.5 <sup>+0.08</sup> <sub>0</sub>	35	10.5 <sup>+0.2</sup>	27	43	47	55	M45×2	R0.5
MALC-8HP										

MALC-2 to 8HSP-FL type (With flange)

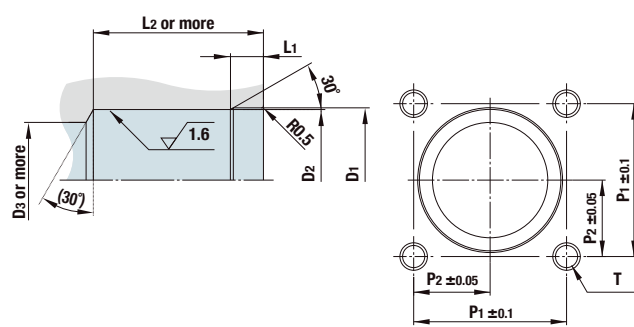



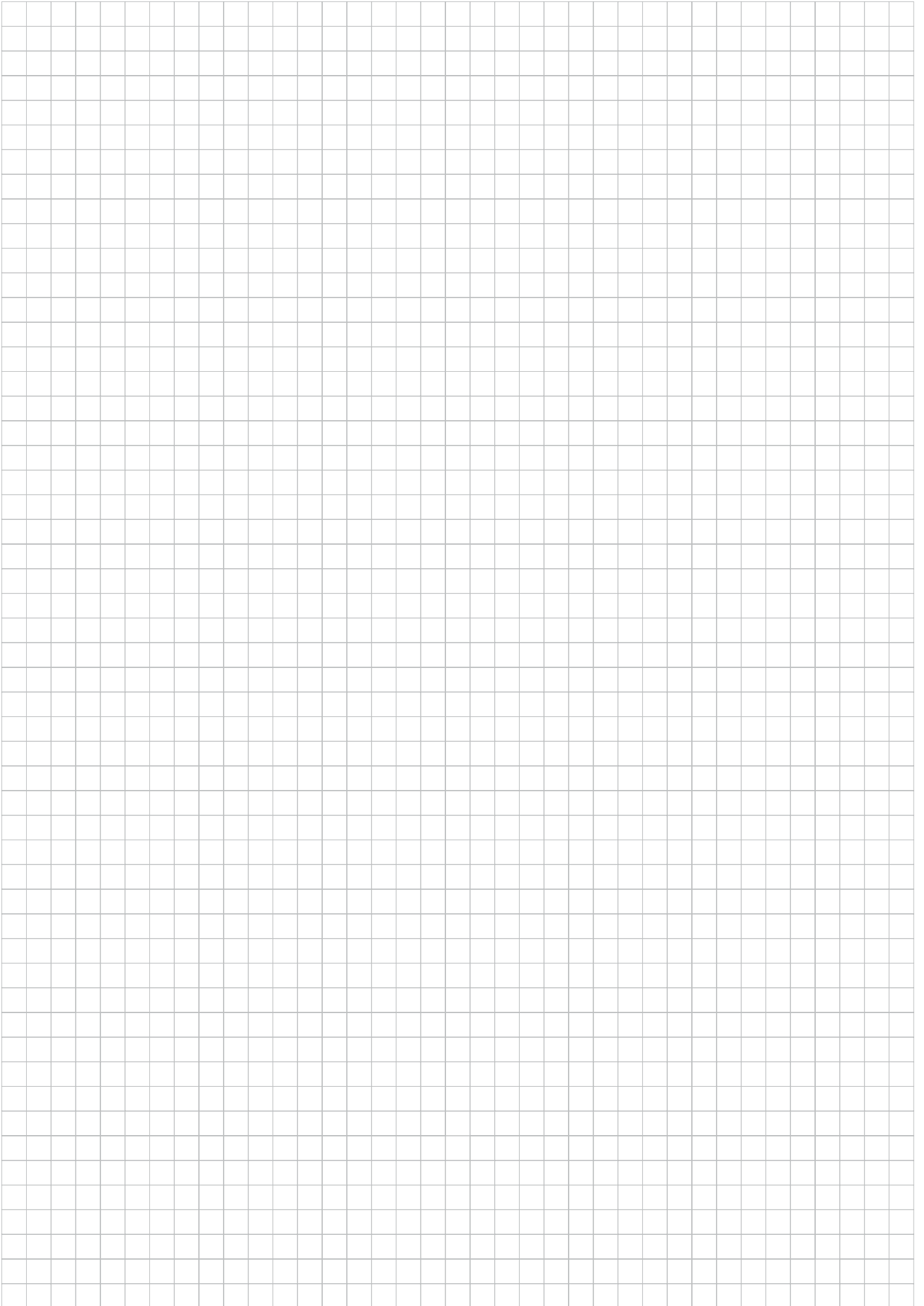



Model	Dimensions (mm)							
	øD1	øD2	øD3	L1	L2	P1	P2	T
MALC-2HS-FL	23 <sup>+0.1</sup> <sub>0</sub>	22 <sup>+0.06</sup> <sub>0</sub>	16	2.8 <sup>+0.2</sup> <sub>0</sub>	28	28	14	4×M6 Thread depth 17 mm or more
MALC-2HP-FL					19			
MALC-3HS-FL	27.1 <sup>+0.1</sup> <sub>0</sub>	26 <sup>+0.08</sup> <sub>0</sub>	18	2.8 <sup>+0.2</sup> <sub>0</sub>	28	31	15.5	
MALC-3HP-FL					22			
MALC-4HS-FL	37.7 <sup>+0.3</sup> <sub>0</sub>	36.5 <sup>+0.08</sup> <sub>0</sub>	26	6 <sup>+0.2</sup>	39	40	20	
MALC-4HP-FL					30.5			
MALC-6HS-FL	42.5 <sup>+0.3</sup> <sub>0</sub>	41.5 <sup>+0.08</sup> <sub>0</sub>	30	6 <sup>+0.2</sup>	50	45	22.5	4×M10 Thread depth 15 mm or more
MALC-6HP-FL					40			
MALC-8HS-FL	47.5 <sup>+0.3</sup> <sub>0</sub>	46.5 <sup>+0.08</sup> <sub>0</sub>	35	10.5 <sup>+0.2</sup>	53	55	27.5	
MALC-8HP-FL					43			



For High Purity Chemicals

# SEMICON CUPLA SP Type

For semiconductor manufacturing production installation

<b>Working pressure</b>	<b>Valve structure</b>	<b>Applicable fluids</b>			
 0.2 MPa (2 kgf/cm <sup>2</sup> )	 Two-way shut-off				
		High purity chemicals	Water	Gas	Air

**General purpose type with stainless steel body and rubber seal.  
Electro-polished body for enhanced corrosion resistance.**

- Body and valve springs are stainless steel (SUS304). Body is electro-polished for enhanced corrosion resistance.
- Seal materials can be selected to suit your fluid and application, to flexibly comply with your semiconductor production process requirements.
- All components are cleaned, assembled, inspected, and then packed in a clean room.
- Grease free. No grease is applied to the seal material.
- Each plug comes with a dust cap.
- Stainless steel SUS316 body and valve springs are available as made-to-order products.



Specifications				
Body material	Electropolished stainless steel (SUS304)			
Size (Thread)	1/8", 1/4", 3/8", 1/2", 3/4", 1" 1/8-27NPT, 1/4-18NPT, 19/32-18UNS			
Pressure unit	MPa	kgf/cm <sup>2</sup>	bar	PSI
Working pressure	0.2	2	2	29
Seal material Working temperature range <sup>*1</sup>	Seal material	Mark	Working temperature range	Remarks
	Fluoro rubber	FKM	0°C to +50°C	Standard material
	Ethylene-propylene rubber	EPDM	0°C to +50°C	Standard material
	Perfluoroelastomer	P	0°C to +50°C	Standard material
	Kalrez	KL	0°C to +50°C	Standard material

\*1: The operable temperature range depends on the operating conditions.

Maximum Tightening Torque		Nm {kgf·cm}					
Size	1/8-27NPT Rc 1/8	1/4-18NPT Rc 1/4	19/32-18UNS	Rc 3/8	Rc 1/2	Rc 3/4	Rc 1
Torque	9 {92}	14 {143}	20 {204}	22 {224}	60 {612}	90 {918}	120 {1224}

**Interchangeability**  
Sockets and plugs can be connected regardless of end configurations if the first number in the model name is the same.

Minimum Cross-Sectional Area		(mm <sup>2</sup> )				
Model	1SP	2SP	3SP	4SP	6SP	8SP
Min. cross-sectional area	13	17	48	64	83	192

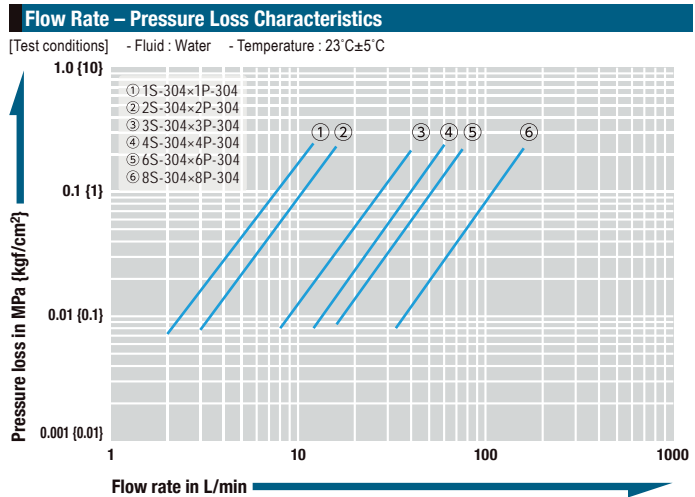

## Models and Dimensions

Plug		Female thread				
Model	Container capacity	Mass (g)	Dimensions (mm)			
			L	C	H(WAF)	T
1P-304	For 10L to 20L	19	29	19	Hex.14	Rc 1/8
1P-304-NPT	For 10L to 20L					1/8-27NPT
1P-304-UNS	For 10L to 20L	34	33	19	Hex.21	19/32-18UNS
2P-304	For 10L to 20L	35	36	22	Hex.17	Rc 1/4
2P-304-NPT	For 10L to 20L					1/4-18NPT
2P-304-UNS	For 10L to 20L	41	36	22	Hex.21	19/32-18UNS
3P-304	For 100L to 200L	60	40	25	Hex.21	Rc 3/8
4P-304	For 100L to 200L	115	44	28	Hex.29	Rc 1/2
6P-304	For 100L to 200L	216	52	36	Hex.35	Rc 3/4
8P-304	For 100L to 200L	352	62	40	Hex.41	Rc 1

\* Above are the dimensions of SUS304.

\* The appearance of SUS304 and 316 bodies is different.







WAF : WAF stands for width across flats.

Socket		Female thread				
Model	Container capacity	Mass (g)	Dimensions (mm)			
			L	øD	H(WAF)	T
1S-304	For 10L to 20L	82	48	24	14	Rc 1/8
1S-304-NPT	For 10L to 20L	84				1/8-27NPT
2S-304	For 10L to 20L	138	58	28	19	Rc 1/4
2S-304-NPT	For 10L to 20L					1/4-18NPT
3S-304	For 100L to 200L	204	65	35	21	Rc 3/8
4S-304	For 100L to 200L	424	72	45	29	Rc 1/2
6S-304	For 100L to 200L	708	88	55	35	Rc 3/4
8S-304	For 100L to 200L	1081	102	65	41	Rc 1

For High Purity Chemicals

# SEMICON CUPLA SCS Type

For semiconductor manufacturing equipment

<b>Working pressure</b>	<b>Valve structure</b>	<b>Applicable fluids</b>			
 0.2 MPa (2 kgf/cm <sup>2</sup> )	 Two-way shut-off	 High purity chemicals	 Water	 Gas	 Air

## Adopted stainless steel body and fluorine contained resin valves.

- The body and spring material of stainless steel (SUS304), and valve of fluorine contained resin ensure excellent performance with various chemicals.
- Body (SUS304) is electropolished for enhanced corrosion resistance.
- All components are cleaned, assembled, inspected, and then packed in a clean room.
- Grease free. Grease is not applied to the seal material.
- Plug comes with a dust cap.

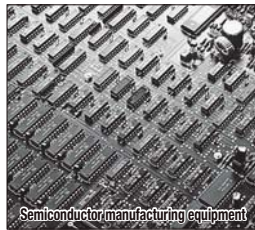

Specifications				
Body material	Electropolished stainless steel (SUS304)			
Size (Thread)	1/8", 1/4", 3/8", 1/2", 3/4", 1" 1/8-27NPT, 1/4-18NPT, 19/32-18UNS			
Pressure unit	MPa	kgf/cm <sup>2</sup>	bar	PSI
Working pressure	0.2	2	2	29
Seal material	Socket	Seal material	Mark	Working temperature range
	O-ring	Perfluoroelastomer	P	0°C to +50°C
Working temperature range <sup>1</sup>	Valve	Fluoropolymer resin (Socket: PFA, Plug: PTFE except 1P and 2P of PFA)		

<sup>1</sup>: The operable temperature range depends on the operating conditions.  
- If you need a seal material other than perfluoroelastomer, please consult with us.

Maximum Tightening Torque		Nm {kgf·cm}					
Size	1/8-27NPT Rc 1/8	1/4-18NPT Rc 1/4	19/32-18UNS	Rc 3/8	Rc 1/2	Rc 3/4	Rc 1
Torque	9 (92)	14 (143)	20 (204)	22 (224)	60 (612)	90 (918)	120 (1224)

**Interchangeability**  
Sockets and plugs can be connected regardless of end configurations if the number □ in the model name {SCS-□S (P)} is the same.  
The plugs can be connected with sockets of SCY Type of the same size. See below chart for details.

Interchangeability Check List (SCS Type, SCY Type)		Socket							
Plug	Model	SCS Type		SCY Type					
		-1S	-2S	-1S	-2S	-3S	-4S	-6S	-8S
SCS Type	-1P	●		●					
	-2P		●		●				
	-3P					●			
	-4P						●		
	-6P							●	
	-8P								●



● indicates connection capability except for made-to-order products.

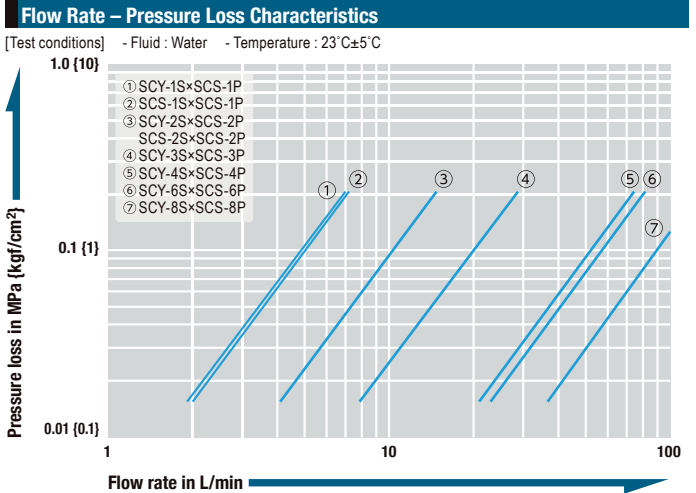

Minimum Cross-Sectional Area		(mm <sup>2</sup> )				
Model	SCS-1SP	SCS-2SP	SCS-3P	SCS-4P	SCS-6P	SCS-8P
Min. cross-sectional area	15	23	28	71	110	162

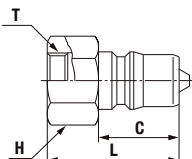

### Models and Dimensions

WAF : WAF stands for width across flats.

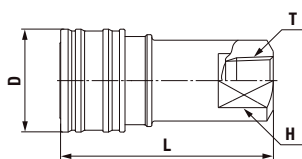





Plug		Female thread				
						
Model	Container capacity	Mass (g)	Dimensions (mm)			
			L	C	H(WAF)	T
SCS-1P	For 10L to 20L	17	29	19	Hex.14	Rc 1/8
SCS-1P-NPT	For 10L to 20L					1/8-27NPT
SCS-1P-UNS	For 10L to 20L	34	33	19	Hex.21	19/32-18UNS
SCS-2P	For 10L to 20L	32	34	22	Hex.17	Rc 1/4
SCS-2P-NPT	For 10L to 20L	29				1/4-18NPT
SCS-2P-UNS	For 10L to 20L	41	36	22	Hex.21	19/32-18UNS
SCS-3P	For 100L to 200L	61	40	25	Hex.21	Rc 3/8
SCS-4P	For 100L to 200L	114	44	28	Hex.29	Rc 1/2
SCS-6P	For 100L to 200L	198	52	36	Hex.35	Rc 3/4
SCS-8P	For 100L to 200L	338	62	40	Hex.41	Rc 1

Socket		Female thread				
						
Model	Container capacity	Mass (g)	Dimensions (mm)			
			L	øD	H(WAF)	T
SCS-1S-NPT	For 10L to 20L	84	48	24	14	1/8-27NPT
SCS-2S-NPT	For 10L to 20L	138	58	28	19	1/4-18NPT

For High Purity Chemicals

# SEMICON CUPLA SCY Type

For semiconductor manufacturing equipment

<b>Working pressure</b>	<b>Valve structure</b>	<b>Applicable fluids</b>			
 0.2 MPa (2 kgf/cm <sup>2</sup> )	 Two-way shut-off				
		High purity chemicals	Water	Gas	Air

**Fluorine contained resin packing seal and perfluoroelastomer packing seal are used to reduce required connection load and to achieve tight sealing.**

- The material of body and spring are of stainless steel (SUS304), while that of valve is of fluorine contained resin. The combination shows excellent performance with various types of chemicals.
- Body (SUS304) is electropolished for enhanced corrosion resistance.
- All components are cleaned, assembled, inspected, and then packed in a clean room.
- Grease free. Grease is not applied to the seal materials.
- Flanged body makes it easy to operate even with gloves.



Specifications					
Body material	Electropolished stainless steel (SUS304)				
Size (Thread)	1/8", 1/4", 3/8", 1/2", 3/4", 1" 1/8-27NPT, 1/4-18NPT				
Pressure unit	MPa	kgf/cm <sup>2</sup>	bar	PSI	
Working pressure	0.2	2	2	29	
Seal material Working temperature range *1	Socket packing seal	Seal material	Mark	Working temperature range	Remarks
		Perfluoroelastomer Fluoropolymer resin	P PTFE (TF)		
	Valve	Fluoropolymer resin (PTFE [except 1S and 2S of PFA])			

\*1: The operable temperature range depends on the operating conditions.  
- If you need a seal material other than perfluoroelastomer, please consult with us.

### Maximum Tightening Torque Nm {kgf·cm}

See page 144 of SEMICON CUPLA SCS Type.

### Interchangeability

Can be connected with plugs of SCS Type of the same size. See below chart for details.

### Interchangeability Check List (SCS Type, SCY Type)

● indicates connection capability except for made-to-order products.

Plug	Model	Socket							
		SCS Type				SCY Type			
		-1S	-2S	-1S	-2S	-3S	-4S	-6S	-8S
SCS Type	-1P	●		●					
	-2P		●		●				
	-3P					●			
	-4P						●		
	-6P							●	
	-8P								●

### Minimum Cross-Sectional Area (mm<sup>2</sup>)

Model	SCY-1S	SCY-2S	SCY-3S	SCY-4S	SCY-6S	SCY-8S
Min. cross-sectional area	15	23	28	71	110	162

### Flow Rate – Pressure Loss Characteristics

[Test conditions] - Fluid : Water - Temperature : 23°C±5°C

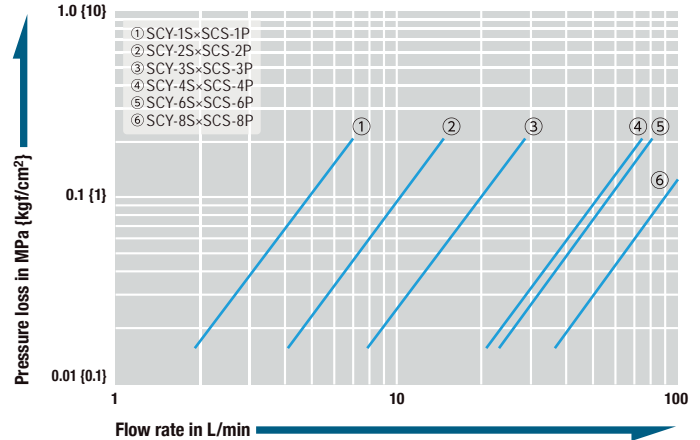

### Models and Dimensions

WAF : WAF stands for width across flats.

### Socket Female thread

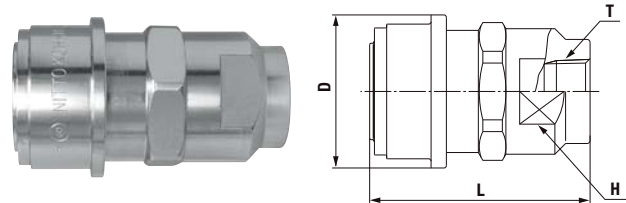

Model	Container capacity	Mass (g)	Dimensions (mm)			
			L	øD	H(WAF)	T
SCY-1S	For 10L to 20L	116	(48)	29	18	Rc 1/8
SCY-1S-NPT	For 10L to 20L					1/8-27NPT
SCY-2S	For 10L to 20L	180	(58)	33	22	Rc 1/4
SCY-2S-NPT	For 10L to 20L					1/4-18NPT
SCY-3S	For 100L to 200L	292	(65)	39	27	Rc 3/8
SCY-4S	For 100L to 200L	519	(72)	50	35	Rc 1/2
SCY-6S	For 100L to 200L	862	(88)	59	41	Rc 3/4
SCY-8S	For 100L to 200L	1360	(102)	68	50	Rc 1



For High Purity Chemicals

# SEMICON CUPLA SCT Type

For semiconductor manufacturing equipment

<b>Working pressure</b> 0.2 MPa (2 kgf/cm <sup>2</sup> )	<b>Valve structure</b> Two-way shut-off	<b>Applicable fluids</b> High purity chemicals Water Gas Air
--	--	--

## Polytetrafluoroethylene (PTFE) is utilised for the body.

- Polytetrafluoroethylene (PTFE) body gives excellent resistance to chemicals.
- Both socket and plug have built-in automatic shut-off valves that prevent fluid from outflowing when disconnected.
- No dissolution of metal ions from part in contact with liquid ensures excellent reliability.
- All components are cleaned, assembled, inspected and then packed in a clean room.
- Appropriate model can be selected from a wide variety of sizes to suit your application/fluid.
- Optional keyway lock to prevent incorrect connection. 10 keyway patterns are available.



Specifications				
Body material	Polytetrafluoroethylene (PTFE)			
Size (Thread)	1/4", 3/8", 1/2", 3/4", 1" 1/4-18NPT, 3/8-18NPT, 1/2-14NPT, 3/4-14NPT, 1-11.5NPT			
Pressure unit	MPa	kgf/cm <sup>2</sup>	bar	PSI
Working pressure	0.2	2	2	29
Seal material	Socket	Seal material	Mark	Working temperature range
Working temperature range <sup>1</sup>	O-ring	FEP-covered fluoro rubber	—	+5°C to +50°C
	Valve	Fluoropolymer resin (PFA)		
Remarks	Standard material			

<sup>1</sup>: The operable temperature range depends on the operating conditions.

### Maximum Tightening amount (approximate)

With seal tape wrapped on the male thread, screw it firmly by hand, and then add more tightening with a wrench as shown below.

1 3/4 to 2 turns	1/4" - 3/8" - 1/2" - 3/4" - 1" Size
------------------	-------------------------------------

Whichever method, overtightening may damage the thread and cause leakage, so take extra care.

### Interchangeability

Sockets and plugs can be connected regardless of end configurations if the number □ in the model name {SCT-□S (P)} is the same.

### Minimum Cross-Sectional Area (mm<sup>2</sup>)

Model	SCT-2SP	SCT-3SP	SCT-4SP	SCT-6SP	SCT-8SP
Minimum cross-sectional area	12	34	54	103	225

### Flow Rate – Pressure Loss Characteristics

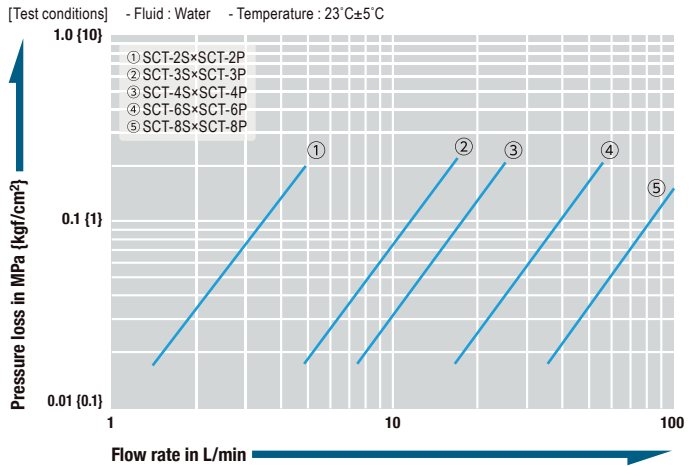

### Models and Dimensions

WAF: WAF stands for width across flats.

Model	Mass (g)	Dimensions (mm)				
		L	A	øC	H(WAF)	T
SCT-2P	43	59	30.5	27.5	24	Rc 1/4
SCT-2P-NPT						1/4-18NPT
SCT-3P	77	68.5	33.5	34.5	30	Rc 3/8
SCT-3P-NPT						3/8-18NPT
SCT-4P	91	69.5	37.5	39.5	36	Rc 1/2
SCT-4P-NPT						1/2-14NPT
SCT-6P	160	78.5	45	48	41	Rc 3/4
SCT-6P-NPT						3/4-14NPT
SCT-8P	300	112	60.5	59	50	Rc 1
SCT-8P-NPT						1-11.5NPT

Model	Mass (g)	Dimensions (mm)			
		L	øD	H(WAF)	T
SCT-2S	101	89.5	41	19	Rc 1/4
SCT-2S-NPT					1/4-18NPT
SCT-3S	156	102	49.5	24	Rc 3/8
SCT-3S-NPT					3/8-18NPT
SCT-4S	192	107	54.5	30	Rc 1/2
SCT-4S-NPT					1/2-14NPT
SCT-6S	340	123	68	36	Rc 3/4
SCT-6S-NPT					3/4-14NPT
SCT-8S	770	172.5	82	46	Rc 1
SCT-8S-NPT					1-11.5NPT

\* Available end configurations are female ISO Rc thread and female NPT thread.

\* Plug or socket with female ISO Rc end configuration has V-groove on the body as identification. (In case of female NPT thread, no V-groove on either plug or socket body).

\* Please inquire for other end configurations other than female thread (e.g. flanged or male thread).

For High Purity Chemicals

# SEMICON CUPLA SCAL Type

For semiconductor manufacturing equipment

<b>Working pressure</b> 0.2 0.2 MPa (2 kgf/cm <sup>2</sup> )	<b>Valve structure</b> Two-way shut-off (Spill Reduction)	<b>Applicable fluids</b> High purity chemicals Water Gas Air
---	---	--

## Body is polytetrafluoroethylene (PTFE).

- Polytetrafluoroethylene (PTFE) body gives excellent resistance to chemicals.
  - Unique seal design ensures minimal liquid spill.
  - Both socket and plug have built-in automatic shut-off valves that prevent fluid from outflowing when disconnected.
  - No dissolution of metal ions from part in contact with liquid ensures excellent reliability.
  - Push-to-connect design.
  - Flanged socket body makes it easy to push down sleeve even when wearing gloves.
  - All components are cleaned, assembled, inspected and then packed in a clean room.
  - Concaved surface of the plug end prevents liquid loss and protects the plug seal surface from damage if dropped or hit.
  - To prevent incorrect connection, a keyed type sleeve is available on a made-to-order basis.
  - Ten key angle positions are available.
- The appearance of the keyed type body slightly differs from that of the standard type.

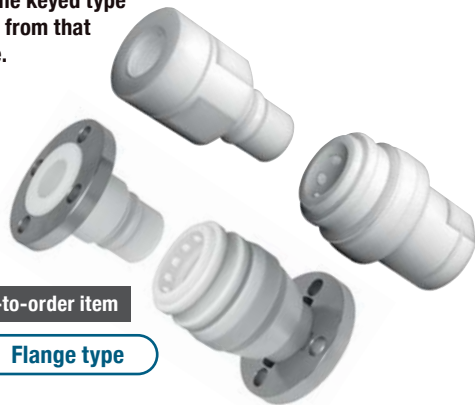

Made-to-order item

Flange type

### Specifications

Body material	Polytetrafluoroethylene (PTFE)			
Size (Thread)	1/4", 3/8", 1/2", 3/4"			
Pressure unit	MPa	kgf/cm <sup>2</sup>	bar	PSI
Working pressure	0.2	2	2	29
Seal material	Socket	Seal material	Mark	Working temperature range
Working temperature range *1	O-ring	Perfluoroelastomer	P	+5°C to +50°C
	Valve	Fluoropolymer resin (PFA)		
Remarks	Standard material			

\*1: The operable temperature range depends on the operating conditions.

### Maximum Tightening amount (approximate)

With seal tape wrapped on the male thread, screw it firmly by hand, and then add more tightening with a wrench as shown below.

1 3/4 to 2 turns	1/4" · 3/8" · 1/2" · 3/4" Size
------------------	--------------------------------

Whichever method, overtightening may damage the thread and cause leakage, so take extra care.

### Interchangeability

Sockets and plugs can be connected regardless of end configurations if the number □ in the model name {SCAL-□S (P)} is the same.

### Minimum Cross-Sectional Area (mm<sup>2</sup>)

Model (SCAL-□)	SCAL-2S × SCAL-2P	SCAL-3S × SCAL-3P	SCAL-4S × SCAL-4P	SCAL-6S × SCAL-6P
Min. Cross-Sectional Area	24	41	59	108

### Volume of Spillage per Disconnection (mL)

Model (SCAL-□)	SCAL-2S × SCAL-2P	SCAL-3S × SCAL-3P	SCAL-4S × SCAL-4P	SCAL-6S × SCAL-6P
Volume of spillage	0.07	0.09	0.13	0.20

### Flow Rate – Pressure Loss Characteristics

[Test conditions] - Fluid : Water - Temperature : 23°C±5°C

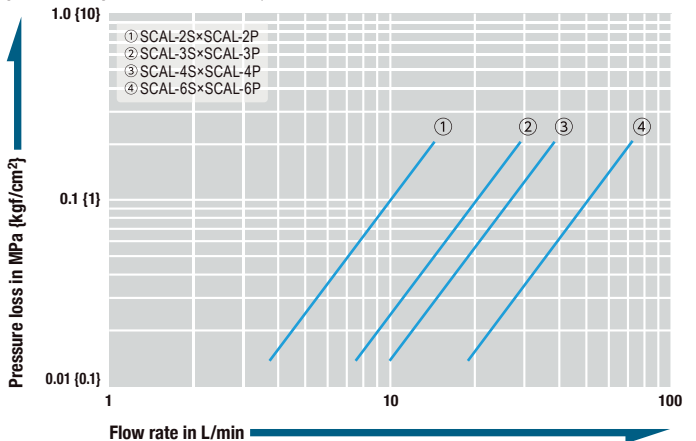

### Models and Dimensions

WAF : WAF stands for width across flats.

Plug		Female thread				
Model	Mass (g)	Dimensions (mm)				
		L	øD	C	H(WAF)	T
SCAL-2P	37	50	27.5	24	24	Rc 1/4
SCAL-3P	73	63	34.5	28	30	Rc 3/8
SCAL-4P	107	72	39.5	30.5	36	Rc 1/2
SCAL-6P	153	77	48	36.5	41	Rc 3/4







- Plug comes with a cap made of high density polyethylene (HDPE).
- Outer appearance of NPT thread type differs slightly from that of the above.
- Please contact us about end configurations other than female thread such as flange and male thread.
- Excessive tightening will damage the threaded part and result in leakage.
- Note: A very small amount of gas can permeate polytetrafluoroethylene (PTFE) bellows in the socket.

Socket		Female thread			
Model	Mass (g)	Dimensions (mm)			
		L	øD	H(WAF)	T
SCAL-2S	97	(60.5)	40.5	27	Rc 1/4
SCAL-3S	135	(69.5)	47	32	Rc 3/8
SCAL-4S	177	(76)	52	36	Rc 1/2
SCAL-6S	339	(90)	65	46	Rc 3/4

For High Purity Chemicals

# SEMICON CUPLA SCF Type

For semiconductor manufacturing equipment

<b>Working pressure</b>	<b>Valve structure</b>	<b>Applicable fluids</b>			
 0.2 MPa (2 kgf/cm <sup>2</sup> )	 Two-way shut-off	 High purity chemicals	 Water	 Gas	 Air

## All plastic model. Fluoropolymer resin (PFA) body.

- All parts made of fluoropolymer resin. O-rings in particular are FEP-covered fluororubber with excellent chemical resistance and no rubber elution.
- To connect with a plug, just push the socket on to it. Disconnection is done in simple and one-handed button operation.
- Unique "double lock mechanism" prevents accidental disconnection of socket and plug.
- Branched tube port improves operability and reduces required piping space.
- Plugs come with a dust cap.
- All components are cleaned, assembled, inspected, and then packed in a clean room.



Specifications					
Body material		Fluoropolymer resin (PFA)			
Size	Thread	3/8", 1/2" / M26, M32			
	Tube barb	ø6 mm×ø8 mm, ø8 mm×ø10 mm			
Pressure unit	MPa	kgf/cm <sup>2</sup>	bar	PSI	
Working pressure	0.2	2	2	29	
Seal material	Socket O-ring Valve	Seal material	Mark	Working temperature range	Remarks
Working temperature range <sup>*1</sup>		FEP-covered fluoro rubber	-	+5°C to +50°C	Standard material
		Fluoropolymer resin (PFA)			

\*1: The operable temperature range depends on the operating conditions.

**Interchangeability**  
Sockets and plugs can be connected regardless of end configurations if the number □ in the model name {SCF-□S (P)} is the same.

Minimum Cross-Sectional Area (mm <sup>2</sup> )		
Model	SCF-2SP	SCF-3SP
Minimum cross-sectional ar	23.8	44.2

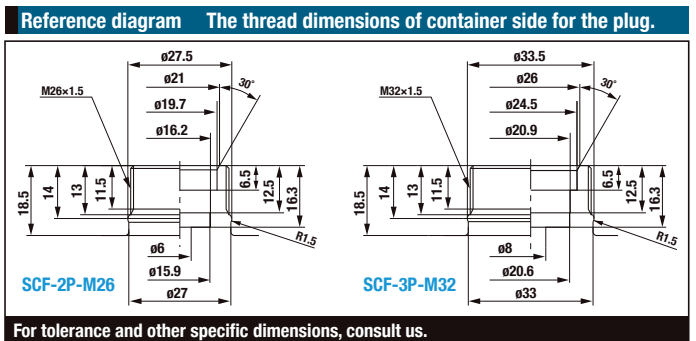
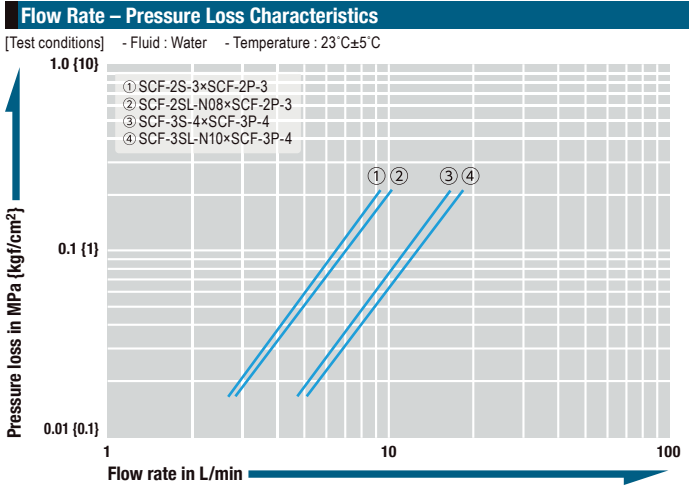

For tolerance and other specific dimensions, consult us.

### Models and Dimensions

WAF : WAF stands for width across flats.

**Plug For container connection**

Model	Container capacity	Mass (g)	Dimensions (mm)			
			L	D(WAF)	C	T
SCF-2P-M26	For 10L to 20L	33	(53.7)	Hex.30×ø32.5	(31.2)	M26×1.5
SCF-3P-M32	For 10L to 20L	50	(57.7)	Hex.36×ø39	(35.2)	M32×1.5

**Socket For tube connection**

Model	Container capacity	Mass (g)	Dimensions (mm)				Applicable tube
			L	D	E		
SCF-2SL-N08	For 10L to 20L	76	77	33	(45)	ø6×ø8	
SCF-3SL-N10	For 10L to 20L	116	85	39	(51)	ø8×ø10	

**Plug Female thread**

Model	Mass (g)	Dimensions (mm)						
		L	C	øD	H(WAF)	A(WAF)	øB	T
SCF-2P-3	53	(67.2)	(31.2)	32.5	Hex.30	24	27	Rc 3/8
SCF-3P-4	79	(71.2)	(35.2)	39	Hex.36	30	33	Rc 1/2

**Socket Female thread (Straight type)**

Model	Mass (g)	Dimensions (mm)					
		L	øA	H(WAF)	D	E	T
SCF-2S-3	83	(92)	27	24	33	(45)	Rc 3/8
SCF-3S-4	124	(102.5)	33	30	39	(51)	Rc 1/2

For Inert Gas and Vacuum

# SP-V CUPLA Type A

For vacuum

Working pressure



Valve structure



Applicable fluids

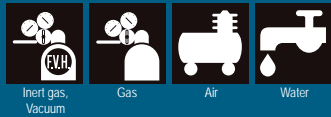

**Automatic shut-off valves in both socket and plug for vacuum applications. Each can withstand a vacuum of as high as  $1.3 \times 10^{-1}$  Pa even when disconnected.**

- Uses automatic shut-off valves with ultra-tight sealed construction in both socket and plug. Ideal for vacuum applications.
- Having automatic shut-off valves in both socket and plug facilitates easy fluid handling. Suitable for a wide range of vacuum applications as high as  $1.3 \times 10^{-1}$  Pa [ $1 \times 10^{-3}$  mmHg] even when disconnected.
- Three types of seal material are available to suit any of the diversified production lines for air conditioners, refrigerators or similar.
- Can be connected with SP CUPLA Type A and SP-V CUPLA.

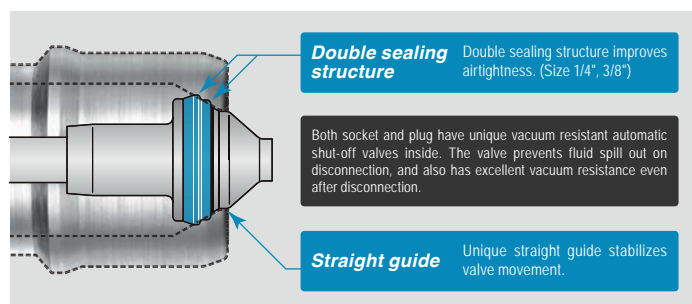

Specifications				
Body material		Brass (Standard material)	Stainless steel (Standard material)	Stainless steel (Made-to-order item)
Size (Thread)		1/4", 3/8"	1/2", 3/4"	1/4", 3/8" 1/2", 3/4"
Working pressure	MPa	5.0	3.0	7.5 4.5
	kgf/cm <sup>2</sup>	51	31	76 46
	bar	50	30	75 45
	PSI	725	435	1090 653
Seal material Working temperature range <sup>*1</sup>	Seal material	Mark	Working temperature range	Remarks
	Chloroprene rubber	CR	-20°C to +80°C	Standard material
	Fluoro rubber	FKM	-20°C to +180°C	Standard material
	Hydrogenated nitrile rubber	HNBR <sup>*2</sup>	-20°C to +120°C	Standard material

\*1: The operable temperature range depends on the operating conditions.

\*2: HNBR which can be used for refrigeration oil and refrigerant applications such as HFC-134a is adopted.

\*3: No grease is applied to the O-ring of the socket for HNBR seal material products when shipping.

Be sure to apply refrigerating machine oil before use.

Maximum Tightening Torque				Nm {kgf·cm}
Size (Thread)		1/4"	3/8"	1/2" 3/4"
Torque	Brass	9 {92}	12 {122}	30 {306} 50 {510}
	Stainless steel	14 {143}	22 {224}	60 {612} 90 {918}

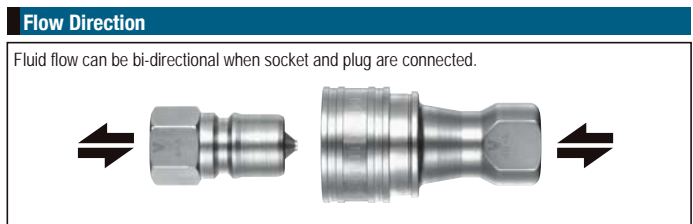

**Interchangeability**

Socket and plug of different sizes cannot be connected. Interchangeable with SP CUPLA Type A, SP-V CUPLA and SP CUPLA of the same size but take heed of flow rate change.

Minimum Cross-Sectional Area				(mm <sup>2</sup> )
Model	2S-V-Ax2P-V-A	3S-V-Ax3P-V-A	4S-V-Ax4P-V-A	6S-V-Ax6P-V-A
Minimum cross-sectional area	27	51	73	178

Suitability for Vacuum			$1.3 \times 10^{-1}$ Pa [ $1 \times 10^{-3}$ mmHg]
Socket only	Plug only	When connected	
Operational	Operational	Operational	

Admixture of Air on Connection				May vary depending upon the usage conditions.	(mL)
Model	2S-V-Ax2P-V-A	3S-V-Ax3P-V-A	4S-V-Ax4P-V-A	6S-V-Ax6P-V-A	
Volume of air admixture	1.1	2.7	3.9	11	

Volume of Spillage per Disconnection				May vary depending upon the usage conditions.	(mL)
Model	2S-V-Ax2P-V-A	3S-V-Ax3P-V-A	4S-V-Ax4P-V-A	6S-V-Ax6P-V-A	
Volume of spillage	0.8	2.1	3.4	9.5	

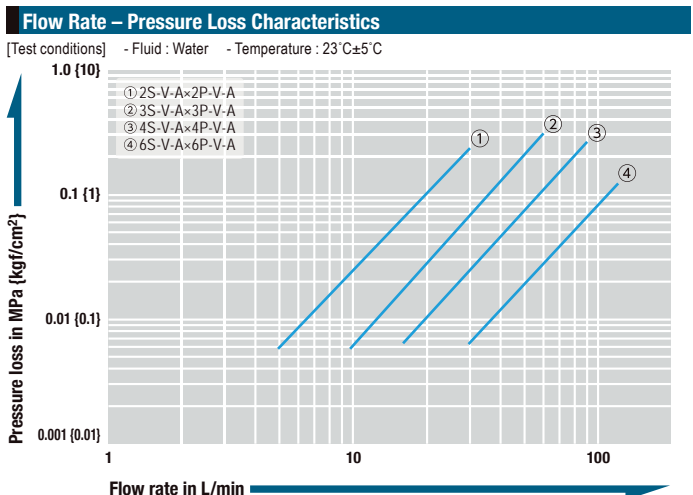

Models and Dimensions

**Plug Female thread**

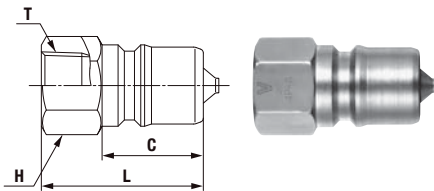

Model	Application (Thread)	Mass (g)		Dimensions (mm)			
		Brass	Stainless steel	L	C	H(WAF)	T
2P-V-A	R 1/4	37	32	36	22	Hex.17	Rc 1/4
3P-V-A	R 3/8	63	56	40	25	Hex.21	Rc 3/8
4P-V-A *	R 1/2	118	109	44	28	Hex.29	Rc 1/2
6P-V-A *	R 3/4	201	189	52	36	Hex.35	Rc 3/4

\*4P-V-A, 6P-V-A, 4S-V-A and 6S-V-A in Stainless Steel material are made-to-order items.

**Socket Female thread**

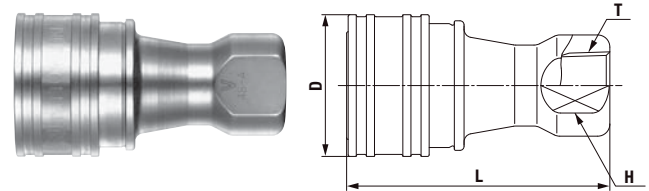

Model	Application (Thread)	Mass (g)		Dimensions (mm)			
		Brass	Stainless steel	L	øD	H(WAF)	T
2S-V-A	R 1/4	130	129	58	28	19	Rc 1/4
3S-V-A	R 3/8	202	192	65	35	21	Rc 3/8
4S-V-A *	R 1/2	396	388	72	45	29	Rc 1/2
6S-V-A *	R 3/4	680	644	88	55	35	Rc 3/4

**Seal materials for refrigerants**

Various eco-friendly refrigerants for air conditioner and refrigerator have been developed. NITTO KOHKI, having invested years in the research and development of excellent seal materials to withstand refrigerants and refrigerant oils, has made early attempts to develop and manufacture the seal materials for these eco-friendly refrigerants.

Seal material	Hydrogenated nitrile rubber	Chloroprene rubber
Mark	HNBR	CR
Features	Resistant to hydrofluorocarbons (HFC-134a, HFC-407C, HFC-410A, HFC-404A), and PAG type and ester type oils. Also resistant to heat up to 120°C	Excellent resistance to hydrofluorocarbons (HCFC-22 and HFC-134a)
Application	Refrigerator production lines Air conditioner production lines	Air conditioner production lines

**How to distinguish from SP CUPLA Type A**

The "V" mark is engraved on the flat part of the plug and the flat part of the socket to distinguish from SP CUPLA Type A.

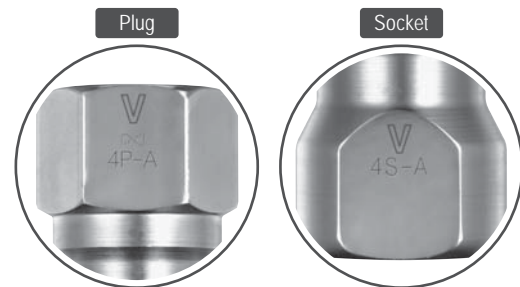

**Application Example**

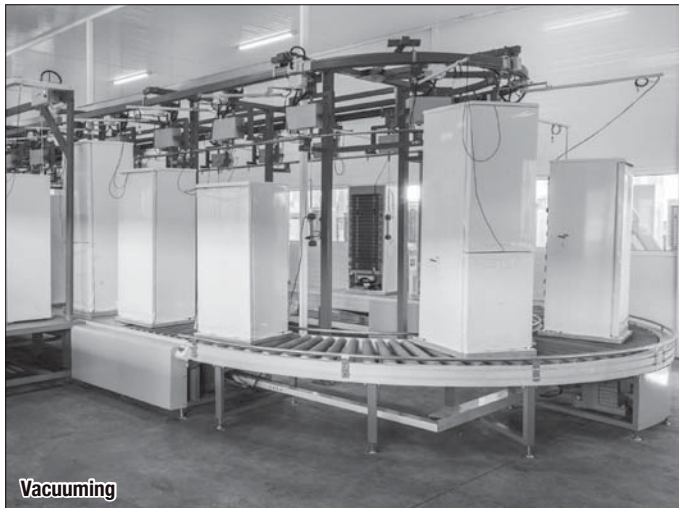

Vacuuming



For Inert Gas and Vacuum

# PCV PIPE CUPLA

For connection to copper pipes

Working pressure

**4.5**  
4.5 MPa  
(46 kgf/cm<sup>2</sup>)

Valveless

Applicable fluids

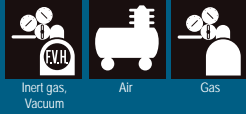

**Clamps directly on straight copper pipes !**  
**Double seal construction withstands a vacuum of up to  $1.3 \times 10^{-1}$  Pa.**

- Clamps directly on to straight copper pipes eliminating unnecessary welding or flaring.
- Withstands a vacuum of up to  $1.3 \times 10^{-1}$  Pa (when connected) making it possible to be used in leak testing, vacuum suction and refrigerant charge.
- Select from three standard types of seal materials to be used with fluids for air conditioner and refrigerator production lines. Many models to suit various pipe sizes.
- One lever operation simultaneously clamps and seals pipe. Double seal construction for tight fit on end and outside surface of pipe ensures excellent sealing and vacuum resistance.



Wide variations of end configurations; 1/4", 3/8" and blind plug

Standard seal materials fluoro rubber (FKM), hydrogenated nitrile rubber (HNBR) and chloroprene rubber (CR) to suit air conditioner and refrigerator production lines

Double seal design for tight fit on both end and outside of pipe

Many models to cover various pipe sizes

One lever operation simultaneously clamps and seals pipe

For exclusive use on straight copper pipes

## Specifications

Model	PCV400	PCV470	PCV500	PCV600	PCV630	PCV800	PCV950	PCV1000	PCV1270	PCV1590
Copper pipe OD mm	ø4.0	ø4.76 (3/16")	ø5.0	ø6.0	ø6.35 (1/4")	ø8.0 (5/16")	ø9.52 (3/8")	ø10.0	ø12.7 (1/2")	ø15.88 (5/8")
Body material	Brass									
Pressure unit	MPa		kgf/cm <sup>2</sup>		bar		PSI			
Working pressure	4.5		46		45		653			
Seal material	Seal material		Mark		Working temperature range		Remarks			
	Chloroprene rubber		CR		-20°C to +80°C		Standard material			
	Fluoro rubber		FKM		-20°C to +180°C		Standard material			
Working temperature range *1		Hydrogenated nitrile rubber		HNBR *2		-20°C to +120°C		Standard material		

\*1: The operable temperature range depends on the operating conditions.

\*2: Hydrogenated nitrile rubber (HNBR) is colored in blue for easy recognition.

\*2: HNBR which can be used for refrigeration oil and refrigerant applications such as HFC-134a is adopted.

## Maximum Tightening Torque

Nm {kgf·cm}

Size (Thread)	1/4"	3/8"
Torque	9 (92)	12 (122)

## Flow Direction

Fluid flow can be bi-directional when socket and plug are connected.

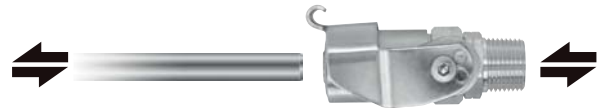

## Minimum Cross-Sectional Area

(mm<sup>2</sup>)

Model	PCV400	PCV470	PCV500	PCV600	PCV630	PCV800
Min. cross-sectional area	3.8	3.8	3.8	9.1	9.1	16.6
Model	PCV950	PCV1000	PCV1270-2	PCV1270-3	PCV1590-2	PCV1590-3
Min. cross-sectional area	16.6	16.6	50.3	73.9	50.3	78.5

## Suitability for Vacuum

$1.3 \times 10^{-1}$  Pa ( $1 \times 10^{-3}$  mmHg)

CUPLA only	When connected to a pipe
-	Operational

## Pipe Outside Diameter, Minimum Pipe Length Required for Insertion, and Minimum Thickness of Pipe Wall

(mm)

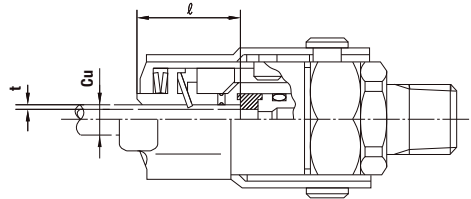

Items with asterisk (\*) are made-to-order products.

Product Group	Pipe OD (Cu)	Minimum Pipe Length Required for Insertion (l)	Minimum Thickness of Pipe Wall (t)
PCV400*	ø4.0	21	0.8 or more
PCV470	ø4.76 (3/16")		
PCV500*	ø5.0		
PCV600	ø6.0		
PCV630	ø6.35 (1/4")		
PCV800	ø8.0 (5/16")	22.5	1.0 or more
PCV950	ø9.52 (3/8")		
PCV1000*	ø10.0		
PCV1270	ø12.7 (1/2")	32.5	1.0 or more
PCV1590	ø15.88 (5/8")		

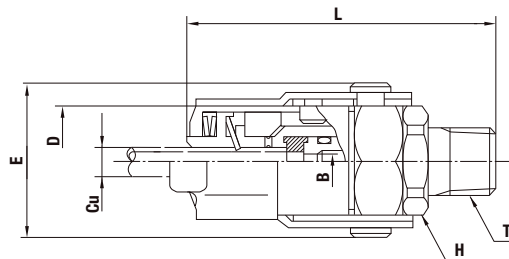
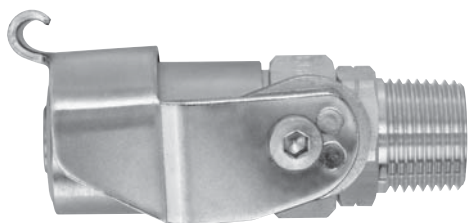

Product Group	Copper pipe OD mm	Model	Application (Thread)	Mass (g)	Dimensions (mm)					
					L	øD	H(WAF)	øB	E	T
PCV400 *	ø4.0	PCV400-2	Rc 1/4	155	(59)	22.2	Hex.17	2.2	(32.5)	R 1/4
		PCV400-3	Rc 3/8	155	(60)		Hex.19			R 3/8
PCV470	ø4.76 (3/16)	PCV470-2	Rc 1/4	155	(60)	22.2	Hex.17	2.2	(32.5)	R 1/4
		PCV470-3	Rc 3/8	160	(61)		Hex.19			R 3/8
		PCV470-0	Blind plug	160	(47)	-	-	-		
PCV500 *	ø5.0	PCV500-2	Rc 1/4	155	(59)	22.2	Hex.17	2.2	(32.5)	R 1/4
		PCV500-3	Rc 3/8	155	(60)		Hex.19			R 3/8
PCV600	ø6.0	PCV600-2	Rc 1/4	150	(60)	22.2	Hex.17	3.4	(32.5)	R 1/4
		PCV600-3	Rc 3/8	155	(61)		Hex.19			R 3/8
		PCV600-0	Blind plug	155	(47)	-	-	-		
PCV630	ø6.35 (1/4)	PCV630-2	Rc 1/4	145	(60)	22.2	Hex.17	3.4	(32.5)	R 1/4
		PCV630-3	Rc 3/8	150	(61)		Hex.19			R 3/8
		PCV630-0	Blind plug	150	(47)	-	-	-		
PCV800	ø8.0 (5/16)	PCV800-2	Rc 1/4	175	(62)	24.8	Hex.17	4.6	(35.5)	R 1/4
		PCV800-3	Rc 3/8	180	(63)		Hex.19			R 3/8
		PCV800-0	Blind plug	185	(50)	-	-	-		
PCV950	ø9.52 (3/8)	PCV950-2	Rc 1/4	175	(62)	24.8	Hex.17	4.6	(35.5)	R 1/4
		PCV950-3	Rc 3/8	180	(63)		Hex.19			R 3/8
		PCV950-0	Blind plug	180	(50)	-	-	-		
PCV1000 *	ø10.0	PCV1000-2	Rc 1/4	155	(62)	24.8	Hex.17	4.6	(35.5)	R 1/4
		PCV1000-3	Rc 3/8	155	(63)		Hex.19			R 3/8
PCV1270	ø12.7 (1/2)	PCV1270-2	Rc 1/4	470	(80)	34.8	Hex.24	8.0	(45.0)	R 1/4
		PCV1270-3	Rc 3/8	465	(81)		Hex.24			R 3/8
		PCV1270-0	Blind plug	475	(68)	-	-	-		
PCV1590	ø15.88 (5/8)	PCV1590-2	Rc 1/4	424	(80)	34.8	Hex.24	8.0	(45.0)	R 1/4
		PCV1590-3	Rc 3/8	435	(81)		Hex.24			R 3/8
		PCV1590-0	Blind plug	445	(68)	-	-	-		

\* For mass with a plug, add (brass body) 2P-V : 39 g, 3P-V : 67 g, (stainless steel body) 2P-V : 34 g, or 3P-V : 59 g  
 \* Available on request

Clamping Mechanism

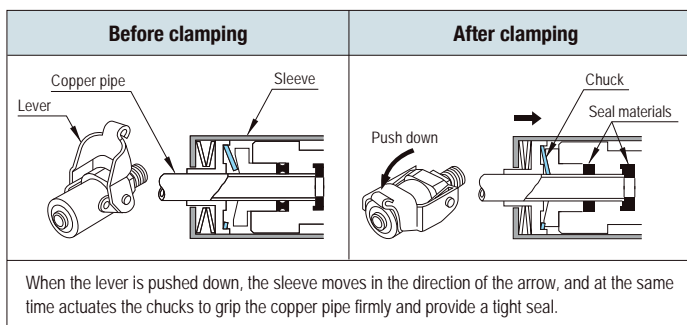

Application Example

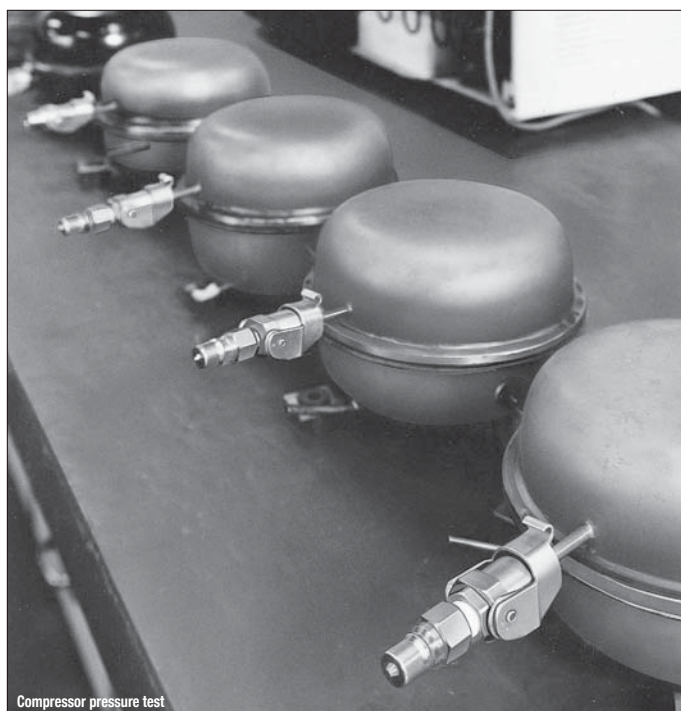

For Paint

# PAINT CUPLA

Piping for painting equipment

<p>Working pressure</p> <p>1.0 MPa (10 kgf/cm<sup>2</sup>)</p>	<p>Valve structure</p> <p>One-way shut-off</p>	<p>Applicable fluid</p> <p>Solvent based paint</p>
--	--	--

## Quick connection and disconnection of paint spray gun and paint fluid line is realized.

- Unique swing connection system enables easy connection and disconnection of paint spray gun and paint hose even by gloved hands.
- Full-open gate valve mechanism prevents paint precipitate buildup.
- Adoption of special resin seal that has resistance against solvents made it possible to feature superior durability, long stable capability, and easy cleaning of paint spray gun after the job.
- Connection and disconnection can be made even if paint sticks to the socket sleeve.
- Small and lightweight design (80 g per set) reduces the weight to be held by hand of operators.
- Built-in sleeve lock mechanism prevents accidental disconnection of CUPLA, ensuring safe operation.
- Wide variety of end configurations (standard thread: G 3/8) are available in response to various paint spray guns.



### Flow Direction

Fluid must run from socket to plug.



### Models and Dimensions

#### Plug PE-3P type (Female thread)

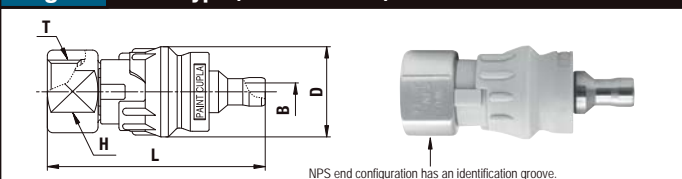

Model	Application (Thread)	Mass (g)	Dimensions (mm)				
			L	øD	øB	H(WAF)	
PE-3P-G	G 3/8	31	(58)	24	4.5	19	G 3/8
PE-3P-NPS	3/8 NPS	31	(58)	24	4.5	19	3/8 NPS

### Specifications

Body material	Socket : Aluminum alloy Plug : Stainless steel			
Size (Thread)	3/8", 3/8NPS			
Pressure unit	MPa	kgf/cm <sup>2</sup>	bar	PSI
Working pressure	1.0	10	10	145
Seal material	Seal material	Mark	Working temperature range	Remarks
Working temperature range *1	Fluoro-resin	PFA	0°C to +50°C	Standard material

\*1: The operable temperature range depends on the operating conditions.

### Tightening Torque Range

Nm {kgf·cm}

Torque	15 {153}
--------	----------

### Interchangeability

Sockets and plugs can be connected regardless of end configurations.

### Suitability for Vacuum

Not suitable for vacuum application in either connected or disconnected condition.

### Flow Rate – Pressure Loss Characteristics

[Test conditions] - Fluid : Water - Temperature : 23°C±5°C

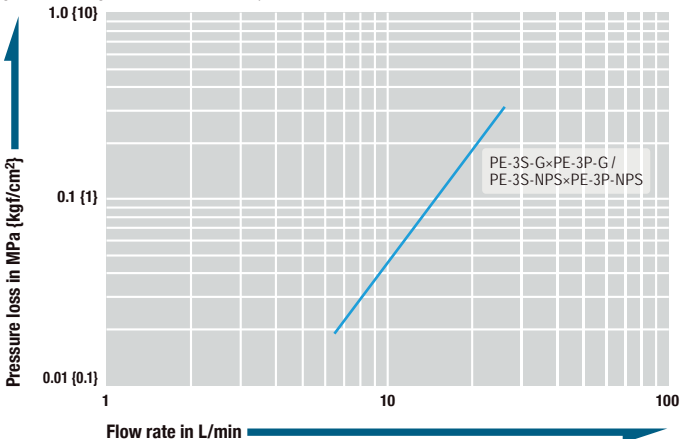

### Connection and Disconnection

#### Connection

Align the key on plug cover to the slot on sleeve, then while pulling the socket sleeve insert the plug to the hilt.

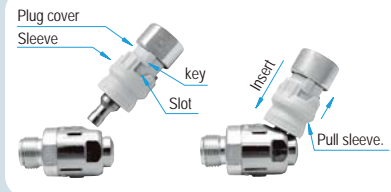

While keeping the plug inserted into the socket, tilt the plug so as to align the plug with the socket. Lock can be made by turning the sleeve.

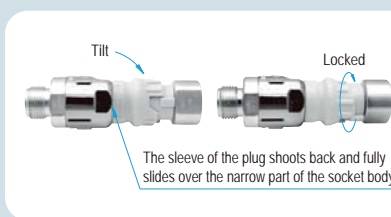

#### Disconnection

Disconnect in the reverse order of connection.

WAF : WAF stands for width across flats.

#### Socket PE-3S type (Male thread)

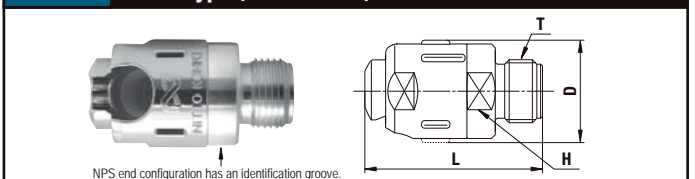

Model	Application (Thread)	Mass (g)	Dimensions (mm)				
			L	øD	H(WAF)	T	
PE-3S-G	G 3/8	48	(47)	27	23		G 3/8
PE-3S-NPS	3/8 NPS	48	(47)	27	23		3/8 NPS

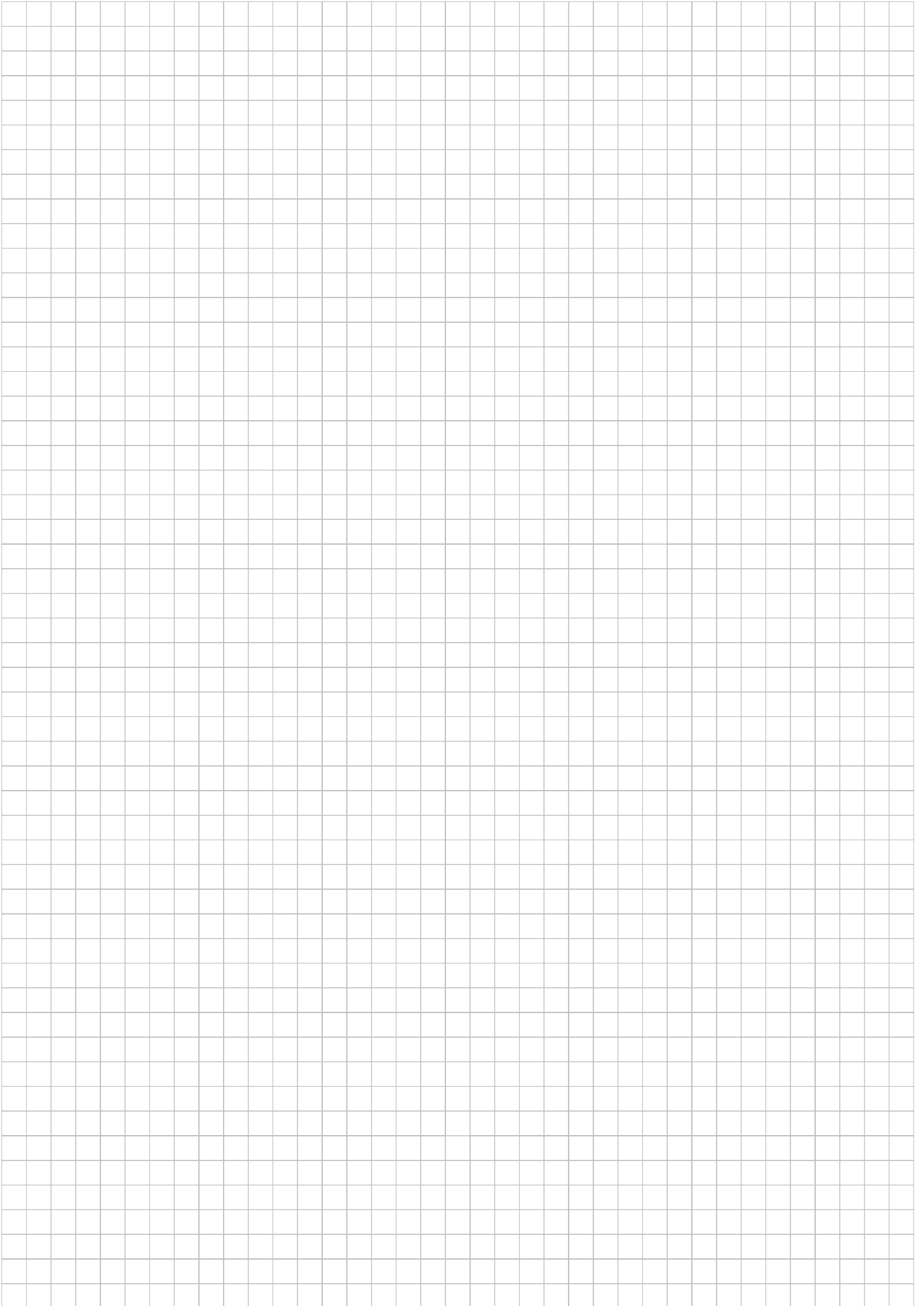

For Food

# HYGIENIC CUPLA

## Easy Wash Type

Disassemble and wash type / For food manufacturing piping

<b>Working pressure</b> 1.0 1.0 MPa (10 kgf/cm <sup>2</sup> )	<b>Valve structure</b> Straight through	<b>Applicable fluids</b> Food, Drinking water Water Powder Air
--	--	--

**Solves the troubles of ferrule joints by the effortless operation unique to CUPLA. Easy disassembly and cleanability help in hygienic management of HACCP.**

- It can be connected by just inserting the plug to the socket and twisting the "Safety lock".
- The "Safety lock" feature ensures that there can be no unintentional disconnection of the coupling.
- O-rings that conforms to the Food sanitation Act of Japan is adopted.
- An operator friendly design. Seal parts will not drop off during connection like conventional fittings.
- Stainless steel (JIS SUS316L equivalent) for the liquid contact parts, and finished with buffing (#400).

Smart Connect and Disconnect



**Ferrule type**  
(ISO 2852 standard)

**Welding type**  
(JIS G 3447 standard)

Specifications				
Body material	Stainless steel [ SCS16 (JIS SUS316L equivalent) ] *1			
Surface finish of the liquid-contact part	Buff finish #400			
Size of end configurations	Welding type *2		Ferrule type *3	
	1.5 S / 2.0 S			
Pressure unit	MPa	kgf/cm <sup>2</sup>	bar	PSI
Working pressure	1.0	10	10	145
Seal material *4 Working temperature range *5	Seal material	Mark	Working temperature range	Remarks
	Silicone rubber	SI	0°C to +110°C	Standard material
	Fluoro rubber	FKM	0°C to +180°C	Available on request
	Ethylene-propylene rubber	EPDM	0°C to +150°C	Available on request
O-ring size	1.5 S: P38, 2.0 S: P50 (Dimensions, tolerance: refer to JIS B 2401, Hardness: A70±5)			

\*1: All metal parts are equivalent to SUS304 except those exposed to liquid contact.  
 \*2: The dimensions of the weld zone conform to JIS G 3447 stainless steel sanitary pipe.  
 \*3: Please use ferrule couplings conforming to IDF / ISO 2852.  
 \*4: The seal material conforms to article No.3-D-3-(1) Rubber utensils (except nursing utensils) or Containers / Packages. It has passed both material and elution tests specified in the Food sanitation Act and the standards for Food and Food additives (Notice No.370 of 1959 issued by the Ministry of Health and Welfare of Japan). Conforms to standard No.21CFR 177.2600 of the US Food and Drug Administration (FDA).  
 \*5: The operable temperature range depends on the operating conditions.

**Flow Direction**

Fluid flow can be bi-directional when socket and plug are connected.

**Interchangeability**

Sockets and plugs can be connected regardless of end configurations if the size is same.

Suitability for Vacuum		Vacuum pressure: 53 kPa A
Socket only	Plug only	When connected
-	-	Operational

Vacuum performance may vary depending upon working environment and usage conditions.

**Seal part (cross section)**

Because of the structure of this product, dead space is generated when using.

Enlarged view of seal part

Plug / Socket Connected state

**When installing on the pipe**

Connection and disconnection of socket and plug is enabled by sliding either the socket or plug to the central axis of pipe. When installing on the pipe, ensure that there is at least minimum moving distance (L) in the axial direction.

Amount of sliding (L)  
More than 40 mm

**HACCP: Hazard Analysis and Critical Control Point**  
 HACCP is the management system in which food safety is addressed to the process from production, procurement and handling of raw materials to distribution and consumption of finished products through the analysis and control of biological, chemical and physical hazards.



Models and Dimensions

**Plug** Welding type

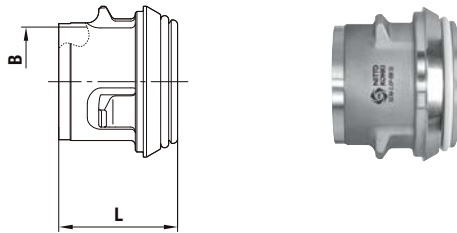

Model	Mass (g)	Dimensions (mm)	
		L	øB
SEW-1.5P-BW *	179	52	35.7
SEW-2.0P-BW *	231	52	47.8

**Socket** Welding type

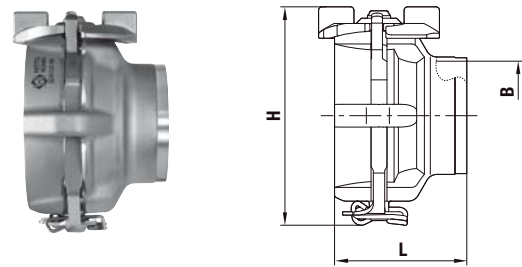

Model	Mass (g)	Dimensions (mm)		
		L	H	øB
SEW-1.5S-BW	364	58	(84)	35.7
SEW-2.0S-BW	455	58	(96)	47.8

**Plug** Ferrule type

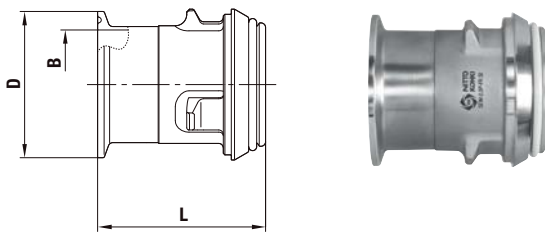

Model	Mass (g)	Dimensions (mm)		
		L	øD	øB
SEW-1.5P-FR *	224	(73.5)	50.5	35.7
SEW-2.0P-FR *	301	(73.5)	64	47.8

**Socket** Ferrule type

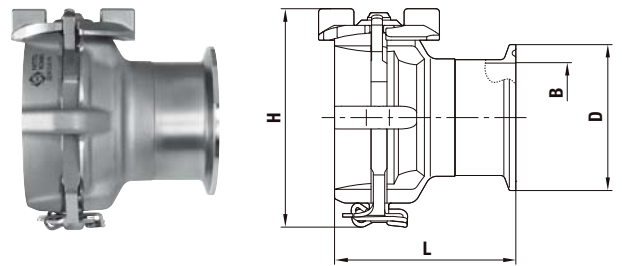

Model	Mass (g)	Dimensions (mm)			
		L	øD	H	øB
SEW-1.5S-FR	407	(79.5)	50.5	(84)	35.7
SEW-2.0S-FR	526	(79.5)	64	(96)	47.8

\* A type without seal material is also available. In such case, the model name ends with "-NP". (ex: SEW-2.0P-BW **-NP**)

Applications

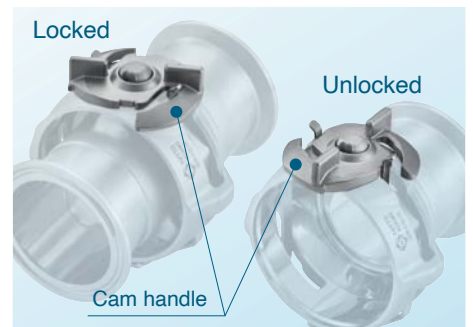

**Easy assembly and disassembly**

No tools are required to disassemble / assemble HYGIENIC CUPLA. Small number of parts that are easy to handle, aiding efficient maintenance.

**Easy washing of the whole unit**

After disassembly, small number of components requires minimum effort when cleaning. No small parts to lose.

**Safety Lock function**

As a safety measure, the "Safety lock" feature ensures that there can be no unintentional disconnection. By turning the cam handle, you can maintain the connected state of the socket and plug.



**Construction and Safety standards**

Since the O-Ring is attached beforehand, it will not drop off during connection like conventional fittings. And the seal material conforms to article No. 3-D-3-(1) Rubber utensils (except nursing utensils) or Containers / Packages. It has passed both material and elution tests specified in the Food sanitation Act and the standards for Food and Food additives (Notice No.370 of 1959 issued by the Ministry of Health and Welfare of Japan). Also conforms to standard No. 21 CFR 177.2600 of the US Food and Drug Administration (FDA).

Accessory

**DUST CAP** Dust cap for both plug and socket (made of polyethylene).

Prevents contamination of foreign matter into piping during separation.

The Dust Cap conforms to No. 3-D-2-(1) and 3-D-2-(2)-4 Apparatus and Containers / Packages. It has passed both material and elution tests specified in the standards for Food and Food additives. (Notice No.201 of revised March 31, 2006 by the Ministry of Health and Welfare of Japan)



See page 164 for the details.

Consumables

The O-ring and Lock plate ASSY are consumable items. See the following list as a replacement guide for the Lock plate ASSY.

Replacement guide

Replacement parts	Connection and disconnection times
Lock plate ASSY	1000 times

Lock plate ASSY

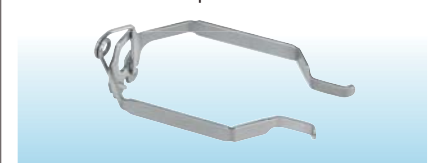

- When the Lock plate ASSY is deformed, replace it with a new one regardless of connection / disconnection times.
- The durability of the O-ring differs depending on the operating environment and conditions (pressure and temperature etc.).



# HSP-DC CUPLA

For high pressure / For hydraulic pressure up to 20.6 MPa {210 kgf/cm<sup>2</sup>}

Working pressure

**20.6**

20.6 MPa  
(210 kgf/cm<sup>2</sup>)

Valve structure



Two-way shut-off

Applicable fluids



Hydraulic oil

## For various applications with large pressure fluctuations.

- "Electroless nickel phosphor plating" which is not soluble to fire-resistant "water glycol type hydraulic fluid" is entirely adopted.
- Valve material with high impact resistance. Available for die casting machines with large pressure fluctuations.
- Various thread sizes available.



### How to distinguish from HSP CUPLA

The "DC" mark is engraved on the flat part of the plug and the flat part of the socket to distinguish from HSP CUPLA.

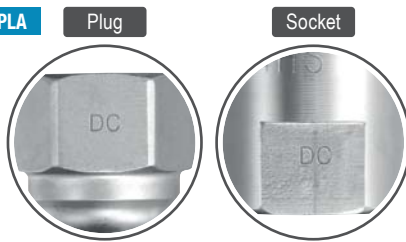

### Application examples

Die-casting machines, Various casting machines, Continuous casting machines, Pipe casting machines, Machine tools, Rolling mills, Molding presses, Forging presses, Powder alloy presses, Blast furnaces, Electric furnaces, Furnace switchgear, Injection molding machines, Adaptable to connections of hydraulic piping such as glass forming equipment, etc.

### Admixture of Air on Connection May vary depending upon the usage conditions. (mL)

Model	2HS-DC x 2HP-DC	3HS-DC x 3HP-DC	4HS-DC x 4HP-DC	6HS-DC x 6HP-DC	66HS-DC x 66HP-DC	8HS-DC x 8HP-DC
Volume of air	0.7	1.9	3.5	3.5	8.2	12.4

### Models and Dimensions (4HSP with 6HSP can be connected with each other whereas 6HSP with 66HSP cannot be connected.)

WAF : WAF stands for width across flats.

Model	Application	Mass (g)	Dimensions (mm)				
			L	øD	C	H (WAF)	T
2HP-DC	R 1/4	40	32	20.5	17.5	Hex.19	Rc 1/4
3HP-DC	R 3/8	68	38	25	22.5	Hex.23	Rc 3/8
4HP-DC	R 1/2	124	44	32	27.5	Hex.29	Rc 1/2
6HP-DC	R 3/4	148	50	35	27.5	Hex.32	Rc 3/4
66HP-DC	R 3/4	232	51	40	28	35	Rc 3/4
8HP-DC	R 1	361	61	47	36	41	Rc 1

Specifications				
Body material	Special steel (Nickel plated)			
Applicable pipe size	1/4", 3/8", 1/2", 3/4", 1"			
Pressure unit	MPa	kgf/cm <sup>2</sup>	bar	PSI
Working pressure	20.6	210	206	2990
Seal material	Seal material	Mark	Working temperature range	Remarks
Working temperature range <sup>*1</sup>	Nitrile rubber	NBR	-20°C to +80°C	Standard material

\*1: The operable temperature range depends on the operating conditions.

Maximum Tightening Torque Nm {kgf·cm}					
Size (Thread)	1/4"	3/8"	1/2"	3/4"	1"
Torque	28 (286)	45 (459)	90 (918)	100 (1020)	180 (1836)

### Flow Direction

Fluid flow can be bi-directional when socket and plug are connected.

### Interchangeability

Interchangeable with standard HSP CUPLA plug or socket in the same size. Use HSP-DC CUPLA for die-casting machines with large pressure fluctuations. The "DC" mark is engraved on the hex. part of the plug and the flat part of the socket to distinguish from HSP CUPLA.

Minimum Cross-Sectional Area (mm <sup>2</sup> )						
Model	2HS-DC x 2HP-DC	3HS-DC x 3HP-DC	4HS-DC x 4HP-DC	6HS-DC x 6HP-DC	66HS-DC x 66HP-DC	8HS-DC x 8HP-DC
Min. cross-sectional area	21	37	77	77	145	203

Suitability for Vacuum 1.3×10 <sup>-1</sup> Pa {1×10 <sup>-3</sup> mmHg}		
Socket only	Plug only	When connected
-	-	Operational

### Flow Rate – Pressure Loss Characteristics

[Test conditions] - Fluid : Hydraulic oil - Temperature : 35°C±5°C  
- Fluid viscosity : 32×10<sup>-6</sup> m<sup>2</sup>/s - Density : 0.87×10<sup>3</sup> kg/m<sup>3</sup>

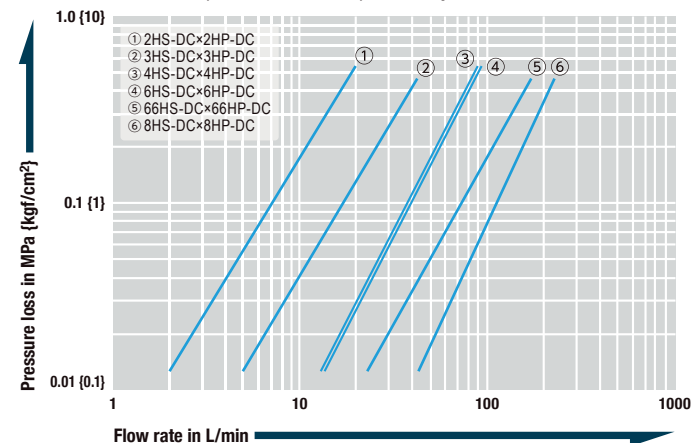

Model	Application	Mass (g)	Dimensions (mm)			
			L	øD	H (WAF)	T
2HS-DC	R 1/4	134	49	(27.5)	19	Rc 1/4
3HS-DC	R 3/8	226	60	(33)	23	Rc 3/8
4HS-DC	R 1/2	485	72	(43)	35	Rc 1/2
6HS-DC	R 3/4	460	72	(43)	35	Rc 3/4
66HS-DC	R 3/4	569	78.5	(47)	35	Rc 3/4
8HS-DC	R 1	1,042	93	(58)	46	Rc 1

# HI FLOW CUPLA

## For Medium Pressure

Working pressure



1.0 MPa  
(10 kgf/cm<sup>2</sup>)

Valve structure



Two-way shut-off

Applicable fluids



Water



Temperature control refrigerant

## Drastically increases flow volume while minimizing pressure drop.

- Both socket and plug have built-in automatic shut-off valves.
  - High flow rate type to increase cooling effect.
  - Quick connection and disconnection of cooling pipes.
  - Compact and space-saving design.
- Compared with the coupled length of SP CUPLA type A, that of HI FLOW CUPLA is reduced by 22%.
- Installation and maintenance can be done within a short time.

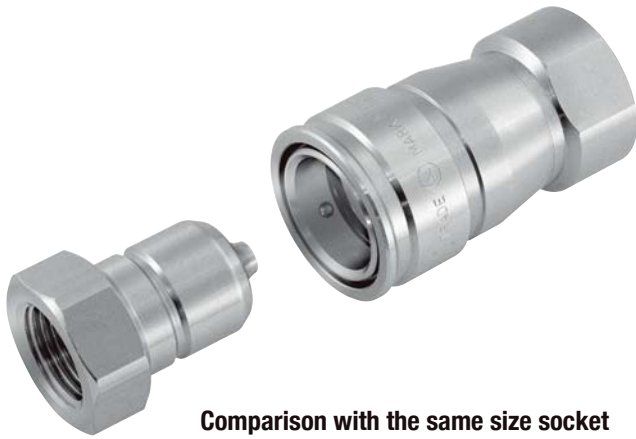

Comparison with the same size socket

Reduced

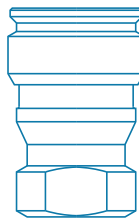

HI FLOW CUPLA  
HFL-4S

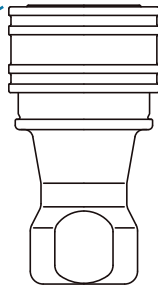

SP CUPLA Type A  
4S-A

## Specifications

Body material	Stainless steel, Brass			
Size (Thread)	1/4", 3/8", 1/2"			
Pressure unit	MPa	kgf/cm <sup>2</sup>	bar	PSI
Working pressure	1.0	10	10	145
Seal material Working temperature range *1	Seal material	Mark		Working temperature range
	Ethylene-propylene rubber	EPDM		-40°C to +150°C
	Fluoro rubber	FKM		-20°C to +180°C

\* Standard seal material is fluoro rubber for brass body.

\*1: The operable temperature range depends on the operating conditions.

## Maximum Tightening Torque

Nm {kgf·cm}

Model	HFL-2P / HFL-2S	HFL-3P / HFL-3S	HFL-4P / HFL-4S
Stainless steel	14 {143}	22 {224}	60 {612}
Brass	9 {92}	12 {122}	30 {306}

## Flow Direction

Fluid flow can be bi-directional when socket and plug are connected.



## Interchangeability

Socket and plug of different sizes cannot be connected.

## Minimum Cross-Sectional Area

(mm<sup>2</sup>)

Model	HFL-2P / HFL-2S	HFL-3P / HFL-3S	HFL-4P / HFL-4S
Minimum Cross-Sectional Area	32	53	91

## Suitability for Vacuum

1.3×10<sup>-1</sup> Pa {1×10<sup>-3</sup> mmHg}

Socket only	Plug only	When connected
-	-	Operational

## Flow Rate – Pressure Loss Characteristics

[Test conditions] - Fluid : Water - Temperature : 23°C±5°C

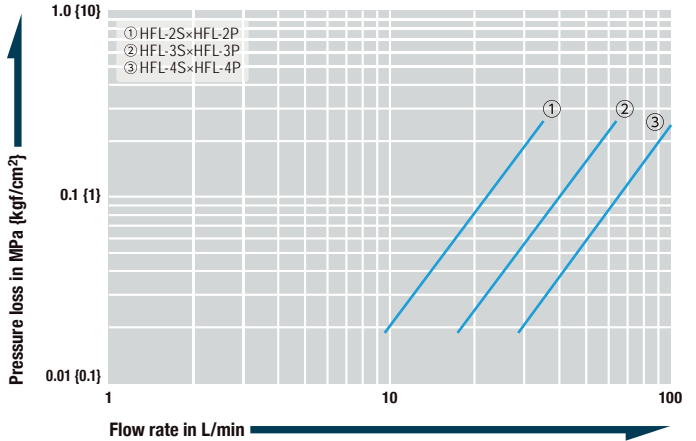

## Models and Dimensions

WAF : WAF stands for width across flats.

### Plug Female thread

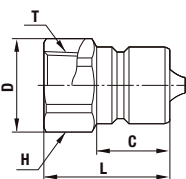

Model	Application (Thread)	Mass (g)		Dimensions (mm)				
		Brass	Stainless steel	L	C	øD	H(WAF)	T
HFL-2P	R 1/4	31	28	30	16.5	18.5	Hex.17	Rc 1/4
HFL-3P	R 3/8	47	43	31	18	23	Hex.21	Rc 3/8
HFL-4P	R 1/2	91	82	37.5	22.5	32	Hex.29	Rc 1/2

### Socket Female thread

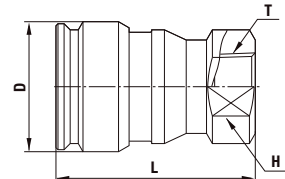

Model	Application (Thread)	Mass (g)		Dimensions (mm)			
		Brass	Stainless steel	L	øD	H(WAF)	T
HFL-2S	R 1/4	110	99	(47)	26	19	Rc 1/4
HFL-3S	R 3/8	165	150	(49)	32	24	Rc 3/8
HFL-4S	R 1/2	231	211	60	35	29	Rc 1/2



# HI FLOW CUPLA BI Type

CUPLA with bite type tube fitting for piping water and fluids for temperature control

Working pressure

**1.0**

1.0 MPa  
(10 kgf/cm<sup>2</sup>)

Valve structure



Two-way shut-off

Applicable fluids



Water  
Temperature control refrigerant

## HI FLOW CUPLA and bite type tube fitting are combined to achieve efficient piping.

- Easy connection with stainless steel pipe.
- Connection to plastic hose is possible with optional hose connection kit.
- Connection to various tubes is also possible via the use of appropriate optional inserts.



Specifications				
Body material	Stainless steel			
Applicable pipe size	1/4", 3/8", 1/2" (See the below list for hose and tube size.)			
Pressure unit	MPa	kgf/cm <sup>2</sup>	bar	PSI
Working pressure	1.0	10	10	145
Seal material	Seal material	Mark	Working temperature range	Remarks
	Ethylene-propylene rubber	EPDM	-40°C to +150°C	Standard material
Working temperature range <sup>1)</sup>	Fluoro rubber	FKM	-20°C to +180°C	Made-to-order item

<sup>1)</sup> The operable temperature range depends on the operating conditions.

### Flow Direction

Fluid flow can be bi-directional when socket and plug are connected.



### Interchangeability

Socket and plug of different sizes cannot be connected.

### Suitability for Vacuum

1.3×10<sup>-1</sup> Pa {1×10<sup>-3</sup> mmHg}

Socket only	Plug only	When connected
-	-	Operational

### Flow Rate – Pressure Loss Characteristics (When connected to stainless steel pipe)

[Test conditions] - Fluid : Water - Temperature : 23°C±5°C

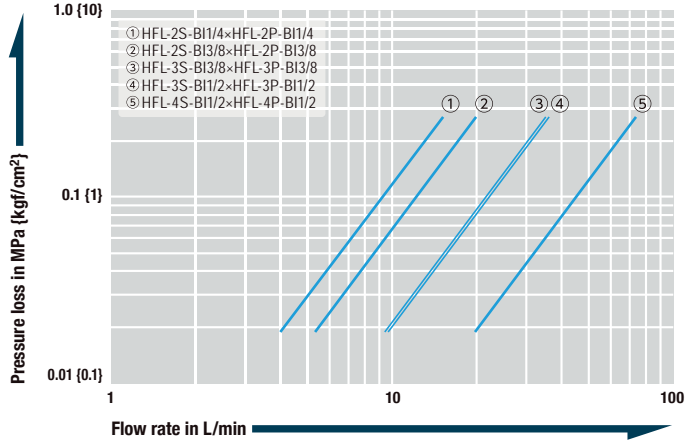

### Stainless steel pipe, hose, and tube size

Model	Stainless steel pipe		Hose connection nut (Optional)		Tube connection insert (Optional)							
	Pipe dia. Inch (mm)	Model	Hose size (ID-OD) mm	Type of insert	Tube dimensions (ID-OD) mm		Insert dimensions					
					E (mm)	L (mm)	A (mm)	D (mm)	WAF (mm)	T (mm)		
HFL-2SP-BI 1/4	1/4 (ø6.35)	-	-	DTI 4-2	ø3.18×ø6.35	2.3	11.9	6.35	3.18			
				DTI 4-2.5	ø3.97×ø6.35	2.7	11.9	6.35	3.97			
				DTI 4-2.72	ø4.32×ø6.35	2.7	11.9	6.35	4.32			
				DTI 4-3	ø4.76×ø6.35	3.5	11.9	6.35	4.76			
HFL-2SP-BI 3/8	3/8 (ø9.53)	-	-	DTI 6-3	ø4.76×ø9.53	3.0	14.3	9.53	4.76			
				DTI 6-4	ø6.35×ø9.53	4.8	14.3	9.53	6.35			
HFL-3SP-BI 3/8	3/8 (ø9.53)	-	-	DTI 6-3	ø4.76×ø9.53	3.0	14.3	9.53	4.76			
				DTI 6-4	ø6.35×ø9.53	4.8	14.3	9.53	6.35			
HFL-3SP-BI 1/2	1/2 (ø12.7)	E1-6×11	ø6×ø11	DTI 8-4	ø6.35×ø12.7	4.8	19.1	12.7	6.35			
				DTI 8-6	ø9.53×ø12.7	7.9	19.1	12.7	9.53			
HFL-4SP-BI 1/2	1/2 (ø12.7)	E1-6×11	ø6×ø11	DTI 8-4	ø6.35×ø12.7	4.8	19.1	12.7	6.35			
				DTI 8-6	ø9.53×ø12.7	7.9	19.1	12.7	9.53			

Note: The material of tube to be applied must be any of nylon, polyester, polypropylene, or fluoropolymer resin. The nut for stainless steel pipe comes with standard HI FLOW CUPLA. For connection to hoses or tubes, an optional hose connection nut or tube connection insert is required.

### Models and Dimensions

WAF : WAF stands for width across flats.

#### Plug For pipe connection

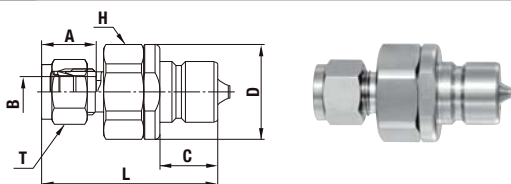

Model	Application (Pipe size) (mm)	Mass (g)	Dimensions (mm)						
			L	C	A	øD	øB	H(WAF)	T(WAF)
HFL-2P-BI 1/4	6.35 (1/4")	66	(51.9)	16.5	(15.4)	23	(6.35)	Hex.20.64 (13/16")	Hex.14.29 (9/16")
HFL-2P-BI 3/8	9.53 (3/8")	74	(53.4)	16.5	(17)	23	(9.53)	Hex.20.64 (13/16")	Hex.17.46 (11/16")
HFL-3P-BI 3/8	9.53 (3/8")	109	(54.8)	18	(17)	29.5	(9.53)	Hex.26.99 (1 1/16")	Hex.17.46 (11/16")
HFL-3P-BI 1/2	12.7 (1/2")	134	(59)	18	(23)	29.5	(12.7)	Hex.26.99 (1 1/16")	Hex.22.23 (7/8")
HFL-4P-BI 1/2	12.7 (1/2")	160	(68.7)	22.5	(23)	32	(12.7)	Hex.28.58 (1 1/8")	Hex.22.23 (7/8")

#### Socket For pipe connection

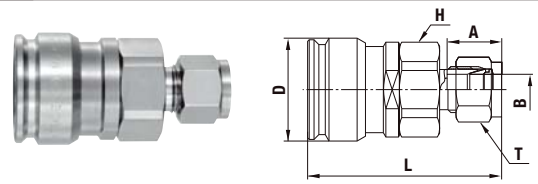

Model	Application (Pipe size) (mm)	Mass (g)	Dimensions (mm)						
			L	A	øD	øB	H(WAF)	T(WAF)	
HFL-2S-BI 1/4	6.35 (1/4")	97	(54.9)	(15.4)	26	(6.35)	Hex.20.64 (13/16")	Hex.14.29 (9/16")	
HFL-2S-BI 3/8	9.53 (3/8")	105	(56.5)	(17)	26	(9.53)	Hex.20.64 (13/16")	Hex.17.46 (11/16")	
HFL-3S-BI 3/8	9.53 (3/8")	165	(60.3)	(17)	32	(9.53)	Hex.26.99 (1 1/16")	Hex.17.46 (11/16")	
HFL-3S-BI 1/2	12.7 (1/2")	189	(64.6)	(23)	32	(12.7)	Hex.26.99 (1 1/16")	Hex.22.23 (7/8")	
HFL-4S-BI 1/2	12.7 (1/2")	233	(73.2)	(23)	35	(12.7)	Hex.28.58 (1 1/8")	Hex.22.23 (7/8")	



# SP CUPLA Type A PV Type

For Medium Pressure / Connectable with residual pressure with Purge Valve

Working pressure

2.0 to 4.5  
2.0 to 4.5 MPa  
(20 to 46 kgf/cm<sup>2</sup>)

Valve structure



Two-way shut-off

Applicable fluids

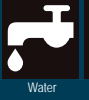

Water Hydraulic oil

## Equipped with residual pressure eliminating valve (up to 1 MPa).

- Automatic shut-off valves in both socket and plug prevent fluid spill out on disconnection.
- Smooth connection even when there is residual pressure when connecting.
- No residual pressure eliminating operation required on your piping. Just connect to purge the remaining pressure.

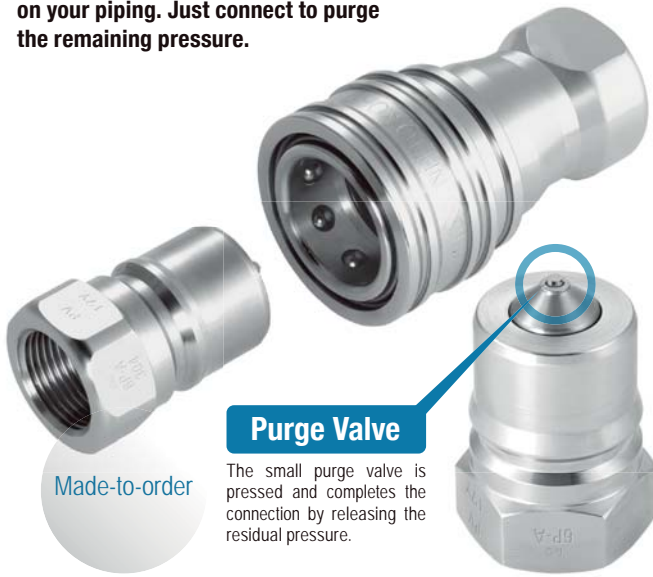

### Purge Valve

The small purge valve is pressed and completes the connection by releasing the residual pressure.

Made-to-order

### Suitability for Vacuum $1.3 \times 10^{-1}$ Pa ( $1 \times 10^{-3}$ mmHg)

Socket only	Plug only	When connected
—	—	Operational

### Admixture of Air on Connection May vary depending upon the usage conditions. (mL)

Model	6S-A-PV x 6P-A	6P-A-PV x 6S-A	8S-A-PV x 8P-A	8P-A-PV x 8S-A	10S-A-PV x 10P-A	10P-A-PV x 10S-A	12S-A-PV x 12P-A	12P-A-PV x 12S-A
Volume of air	11		17		29		45	

### Volume of Spillage per Disconnection May vary depending upon the usage conditions. (mL)

Model	6S-A-PV x 6P-A	6P-A-PV x 6S-A	8S-A-PV x 8P-A	8P-A-PV x 8S-A	10S-A-PV x 10P-A	10P-A-PV x 10S-A	12S-A-PV x 12P-A	12P-A-PV x 12S-A
Volume of spillage	8.4		12		26		36	

### Models and Dimensions

Model	Application (Thread)	Mass (g)		Dimensions (mm)			
		Brass	Stainless steel	L	C	H (WAF)	T
6P-A-PV	R 3/4	204	189	52	36	Hex.35	Rc 3/4
8P-A-PV	R 1	330	307	62	40	Hex.41	Rc 1
10P-A-PV	R 1 1/4	627	617	70	45	Hex.54 (*)	Rc 1 1/4
12P-A-PV	R 1 1/2	917	877	75	49	Hex.63 (**)	Rc 1 1/2

(\*) Stainless steel: WAF 54x059 (\*\*) Stainless steel: WAF 63x068

**Safety Guide:** This product can be connected under residual pressure, but do not connect under dynamic pressure applied. It may lead to incomplete connection, deteriorated durability or possible valve fly out. Read without fail and observe the "Instruction sheet" that comes with the product and the following pages in the general Quick Connect Coupling Catalog: [Precautions Relating to the Use of All CUPLA] and "CUPLA for Low Pressure (Water, Liquid) and for Medium Pressure" in the [Safety Guide] page.

### Specifications

Body material		Brass, Stainless steel (SUS304)							
Model	6S-A-PV	6P-A-PV	8S-A-PV	8P-A-PV	10S-A-PV	10P-A-PV	12S-A-PV	12P-A-PV	
	Socket	Plug	Socket	Plug	Socket	Plug	Socket	Plug	
Size (Thread)		Rc 3/4		Rc 1		Rc 1 1/4		Rc 1 1/2	
Working pressure	Brass	MPa	3.0				2.0		
		kgf/cm <sup>2</sup>	31				20		
		bar	30				20		
	Stainless steel	MPa	4.5				3.0		
		kgf/cm <sup>2</sup>	46				31		
		bar	45				30		
PSI	653				435				
Connectable residual pressure *1		1.0 MPa, 10 kgf/cm <sup>2</sup> , 10 bar, 145 PSI							
Seal material	Nitrile rubber		NBR		Working temperature range		-20°C to +80°C		
Working temperature range *2	Standard material								

\*1: The allowable residual pressure that can be connected when the fluid is limited to liquid.  
\*2: The operable temperature range depends on the operating conditions.

### Maximum Tightening Torque Nm (kgf·cm)

Size (Thread)	Rc 3/4	Rc 1	Rc 1 1/4	Rc 1 1/2	
Torque	Brass	50 (510)	65 (663)	150 (1530)	180 (1836)
	Stainless steel	90 (918)	120 (1224)	260 (2652)	280 (2856)

### Flow Direction

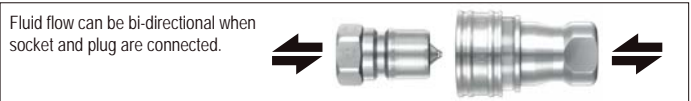

### Interchangeability

Socket and plug of different sizes cannot be connected. Can be connected with SP CUPLA Type A and SP-V CUPLA Type A of the same size but take heed of flow rate change. Refrain from connecting SP CUPLA Type A PV together, since the residual pressure will not release.

### Minimum Cross-Sectional Area (mm<sup>2</sup>)

Model	6S-A-PV x 6P-A	6P-A-PV x 6S-A	8S-A-PV x 8P-A	8P-A-PV x 8S-A	10S-A-PV x 10P-A	10P-A-PV x 10S-A	12S-A-PV x 12P-A	12P-A-PV x 12S-A
Min. Cross-Sectional Area	178		229		395		553	

### Flow Rate – Pressure Loss Characteristics

[Test conditions] - Fluid : Water - Temperature : 23°C±5°C

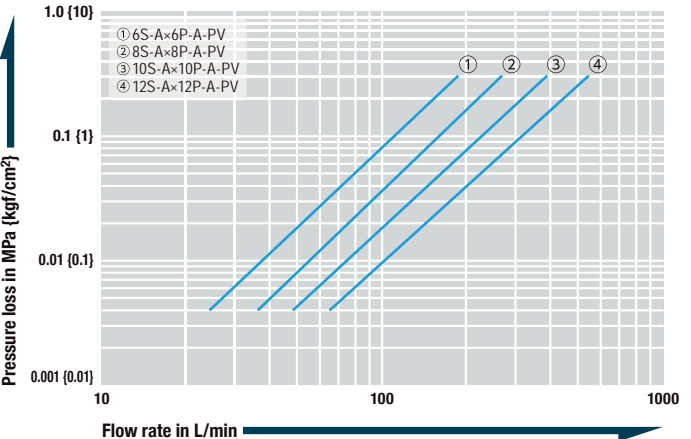

WAF : WAF stands for width across flats.

Model	Application (Thread)	Mass (g)		Dimensions (mm)			
		Brass	Stainless steel	L	øD	H (WAF)	T
6S-A-PV	R 3/4	685	644	88	55	WAF 35	Rc 3/4
8S-A-PV	R 1	1021	959	102	65	WAF 41	Rc 1
10S-A-PV	R 1 1/4	1517	1437	115	77	WAF 54	Rc 1 1/4
12S-A-PV	R 1 1/2	2267	2147	124	88	WAF 63	Rc 1 1/2

# TSP-HP CUPLA for High Pressure

For high pressure and general purposes

Working pressure <b>9.0</b> 9.0 MPa (92 kgf/cm <sup>2</sup> )	Valve structure  Straight through	Applicable fluids  Water Hydraulic oil
--	---	--

- Good for high pressure water piping such as in high pressure washers, or car washers.
- Valveless type ensures high flow rate.



## Specifications

Body material	Stainless steel			
Size (Thread)	1/4", 3/8", 1/2"			
Pressure unit	MPa	kgf/cm <sup>2</sup>	bar	PSI
Working pressure	9.0	92	90	1310
Seal material	Seal material	Mark	Working temperature range	Remarks
Working temperature range *1	Nitrile rubber	NBR	-20°C to +80°C	Made-to-order item
	Ethylene-propylene rubber	EPDM	-40°C to +150°C	

\*1: The operable temperature range depends on the operating conditions.

# PLASTIC CUPLA BC Type Valveless

For low pressure air piping

Working pressure <b>0.07</b> 0.07 MPa (0.7 kgf/cm <sup>2</sup> )	Valve structure  Straight through	Applicable fluid  Air
---	---	-----------------------------

- To connect, just push the plug into the socket.
- Plastic makes this ideal for use in environment prone to rusting.
- Compact and light weight for easy handling.
- Valveless construction gives more stable flow.

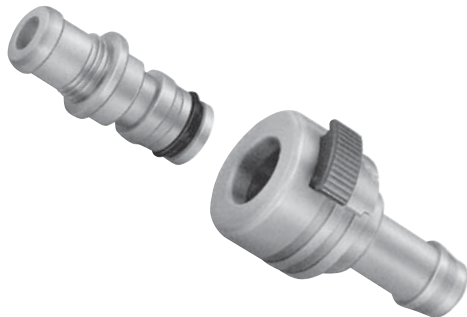

## Models and Dimensions

WAF : WAF stands for width across flats.

### Plug TPF type (Female thread)

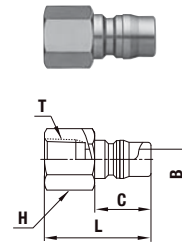

Model	Application (Thread)	Dimensions (mm)				
		L	H(WAF)	C	T	øB
2TPF-HP	R 1/4	34	Hex.17	18	Rc 1/4	6.5
3TPF-HP	R 3/8	38	Hex.21	21	Rc 3/8	10
4TPF-HP	R 1/2	47.5	Hex.29	26.5	Rc 1/2	13

### Socket TSF type (Female thread)

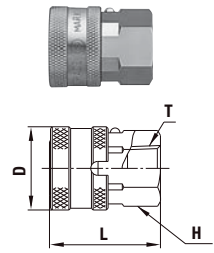

Model	Application (Thread)	Dimensions (mm)			
		L	øD	H(WAF)	T
2TSF-HP	R 1/4	32	24	Hex.19	Rc 1/4
3TSF-HP	R 3/8	35	28	Hex.23	Rc 3/8
4TSF-HP	R 1/2	44.5	35	Hex.29	Rc 1/2

### Plug TPM type (Male thread)

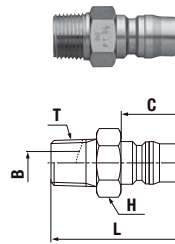

Model	Application (Thread)	Dimensions (mm)				
		L	H(WAF)	C	T	øB
2TPM-HP	Rc 1/4	38	Hex.17	18	R 1/4	6.5
3TPM-HP	Rc 3/8	43	Hex.19	21	R 3/8	10

⚠ Precautions for use

⚠ Warning

Do not connect with standard TSP CUPLA (Page 81 to 84).

## Specifications

Body material	Plastic			
Size	1/4", 3/8" hose			
Pressure unit	MPa	kgf/cm <sup>2</sup>	bar	PSI
Working pressure	0.07	0.7	0.7	10.2
Seal material	Seal material	Mark	Working temperature range	Remarks
Working temperature range *1	Nitrile rubber	NBR	-20°C to +50°C	Standard material

\*1: The operable temperature range depends on the operating conditions.

## Models and Dimensions

WAF : WAF stands for width across flats.

### Plug PH type (Hose barb)

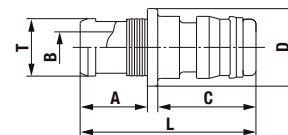

Model	Application (Hose)	Mass (g)	Dimensions (mm)					
			L	C	A	øB	øT	øD
BC-2PH	1/4"	1.8	41	19	17	4	8.5	14
BC-3PH	3/8"	2	34	19	13	6	10.9	15

### Socket SH type (Hose barb)

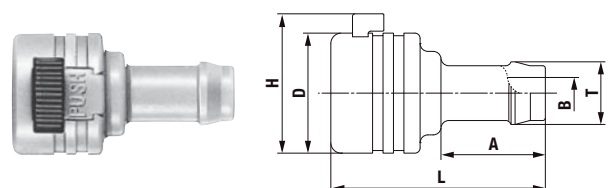

Model	Application (Hose)	Mass (g)	Dimensions (mm)					
			L	A	øB	øT	øD	H
BC-2SH	1/4"	5.6	38	17	4	8.5	23	(26.5)
BC-3SH	3/8"	6	41	20	6	12	23	(26.5)

## DIP MOLD DUST CAP

Dust caps for HI CUPLA, SP CUPLA Type A, TSP CUPLA, and HYDRAULIC CUPLA



- PVC Dust Caps produced by dip molding are available for HI CUPLA, SP CUPLA Type A, TSP CUPLA, and HYDRAULIC CUPLA. Dust Caps prevent dust from getting inside the fluid line and protects the sealability and life of the O-ring.

Caution: The function of the cap may be damaged due to fluid adhering to CUPLA or due to the external environment. Wipe off the fluid from CUPLA to prevent the fluid from adhering.

	Part number	Cap for HI CUPLA	Sales unit
Socket	CA96462	For 20 type	1
		For 30 type	1
		For 40 type	1
Socket	CA96464	For 400 type	1
		For 600 type	1
		For 800 type	1
Plug	CA96453	For 20 type	1
		For 30 type	1
		For 40 type	1
Plug	CA96455	For 400 type	1
		For 600 type	1
		For 800 type	1

	Part number	Cap for 700R CUPLA	Sales unit
Socket	CB00614	For 700R-3S	1
		CA82644	For 700R-4S
Plug	CA83164	For 700R-3P	1
		CA82643	For 700R-4P

	Part number	Cap for SP CUPLA Type A	Sales unit
Socket	CA96462	For 1S-A	1
	CA96463	For 2S-A	1
	CA96464	For 3S-A	1
	CA96465	For 4S-A	1
	CA96466	For 6S-A	1
	CA96467	For 8S-A	1
	CA96468	For 10S-A	1
	CA96449	For 12S-A	1
	CA96470	For 16S-A	1
	Plug	CA96453	For 1P-A
CA96454		For 2P-A	1
CA96455		For 3P-A	1
CA96456		For 4P-A	1
CA96457		For 6P-A	1
CA96458		For 8P-A	1
CA96459		For 10P-A	1
CA96460		For 12P-A	1
CA96461		For 16P-A	1

	Part number	Cap for TSP CUPLA	Sales unit
Socket	CA96542	For 1TS	1
	CA96462	For 2TS	1
	CA96463	For 3TS	1
	CA96464	For 4TS	1
	CA96465	For 6TS	1
	CA96479	For 8TS	1
	CA96553	For 10TS	1
	CA96555	For 12TS	1
	CA96557	For 16TS	1
	Plug	CA96541	For 1TP
CA96453		For 2TP	1
CA96454		For 3TP	1
CA96455		For 4TP	1
CA96456		For 6TP	1
CA96551		For 8TP	1
CA96552		For 10TP	1
CA96459		For 12TP	1
CA96556		For 16TP	1

	Part number	Cap for HSP CUPLA	Sales unit
Socket	CA96463	For 2HS	1
	CA96476	For 3HS	1
	CA96477	For 4HS	1
	CA96477	For 6HS	1
	CA96478	For 66HS	1
	CA96479	For 8HS	1
	CA96481	For 10HS	1
	CA96481	For 12HS	1
	CA96482	For 16HS	1
	Plug	CA96454	For 2HP
CA96455		For 3HP	1
CA96456		For 4HP	1
CA96456		For 6HP	1
CA96471		For 66HP	1
CA96472		For 8HP	1
CA96473		For 10HP	1
CA96473		For 12HP	1
CA96475		For 16HP	1

	Part number	Cap for 210 CUPLA	Sales unit
Socket	CA96463	For 210-2S	1
	CA96476	For 210-3S	1
	CA81555	For 210-4S	1
	CA96478	For 210-6S	1
	CA96466	For 210-8S	1
Plug	CA96454	For 210-2P	1
	CA96455	For 210-3P	1
	CA82643	For 210-4P	1
	CA96471	For 210-6P	1
	CA96551	For 210-8P	1

	Part number	Cap for 280 CUPLA	Sales unit
Socket	CB17082	For 280-2S	1
	CA96476	For 280-3S	1
	CA81555	For 280-4S	1
	CA96478	For 280-6S	1
	CA96466	For 280-8S	1
	Plug	CA96453	For 280-2P
CA83164		For 280-3P	1
CA82643		For 280-4P	1
CA96471		For 280-6P	1
CA96551		For 280-8P	1

	Part number	Cap for F35/350 CUPLA	Sales unit	
Socket	CB28313	For F35-2S	1	
	CA81551	For F35-3S/350-2S, 3S	1	
	CA81555	For F35/350-4S	1	
	CA97213	For F35/350-6S	1	
	CA80401	For F35/350-8S	1	
	Plug	CA96454	For F35-2P	1
		CA81553	For F35-3P/350-2P, 3P	1
		CA81557	For F35/350-4P	1
		CA97215	For F35/350-6P	1
		CA80402	For F35/350-8P	1

	Part number	Cap for ZEROSPILL CUPLA	Sales unit
Socket	CA96463	For ZEL-2S	1
	CA96464	For ZEL-3S	1
	CB28786	For ZEL-4S	1
	CA96466	For ZEL-6S	1
	CA96467	For ZEL-8S	1
	Plug	CA96454	For ZEL-2P
CB28790		For ZEL-3P	1
CA96456		For ZEL-4P	1
CA96457		For ZEL-6P	1
CA96472		For ZEL-8P	1

	Part number	Cap for HSU CUPLA	Sales unit
Socket	CA96463	For HSU-2S	1
	CA96464	For HSU-3S	1
	CA96465	For HSU-4S	1
	CA96466	For HSU-6S	1
	CA96467	For HSU-8S	1
Plug	CB60672	For HSU-2P	1
	CB60673	For HSU-3P	1
	CB60674	For HSU-4P	1
	CB60675	For HSU-6P	1
	CB60676	For HSU-8P	1



Size-adjustable Ring for Dip Mold Cap

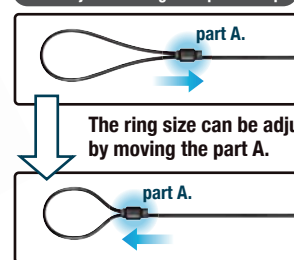

The ring size can be adjusted by moving the part A.

## SAFETY CAP

Metal caps for HI CUPLA Series, SP CUPLA Type A, TSP CUPLA and HYDRAULIC CUPLA

(Semi-standard)

- Metal Cap equipped with dust-proof and leak prevention function.
- Caps with metal material corresponding to that of CUPLA body are available.

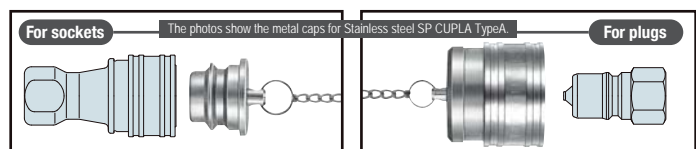

Model	Applicable CUPLA	Sales unit
<p>Model name of Safety Cap is stated in the following manner.</p> <p><b>Model= CUPLA Model (normal CUPLA) + SD (safety cap)</b></p> <p>Example: "2S-A-SD" identifies a safety cap for SP CUPLA Type A Model 2S-A.</p>	<p>Sockets and plugs for HI CUPLA, SP CUPLA Type A, TSP CUPLA, HSP CUPLA, 210 CUPLA, S210 CUPLA, 450B CUPLA and SP-V CUPLA Type A</p>	1 pc.

# DUST CAP

DUST CAP Plastic Cap for HI CUPLA Series and FULL BLOW CUPLA



\*The 20S-D cannot be used together with the SLEEVE COVER.

- Dust caps prevent dust from getting inside CUPLA.

Part number	Model	Applicable CUPLA	Sales unit	Material
CQ12434	20S-D	Sockets for 20/30/40 type HI CUPLA Series <small>Note: Dust caps cannot be attached to the sockets for FULL BLOW CUPLA, 400/600/800 type of HI CUPLA and HI CUPLA ACE.</small>	1	Polyvinyl chloride (PVC)
CQ30978	FBH-D	FULL BLOW CUPLA	1	Polyvinyl chloride (PVC)

# DUST CAP

Dedicated polyethylene cap for HYGIENIC CUPLA

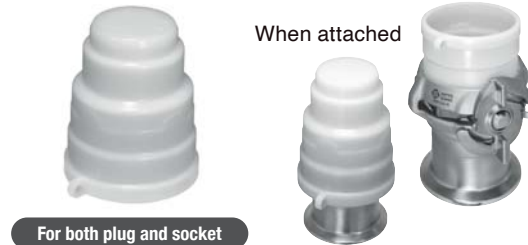

- Dust cap for both plug and socket (made of polyethylene).

The Dust Cap conforms to No. 3-D-2-(1) and 3-D-2-(2)-4 Apparatus and Containers/Packages. It has passed both material and elution tests specified in the standards for Food and Food additives. (Notice No.201 of revised March 31, 2006 by the Ministry of Health and Welfare of Japan)

Model	Size	Applicable CUPLA	Sales unit	Material
SEW-1.5SP-D	1.5S	For HYGIENIC CUPLA Plug and Socket	1	Polyvinyl chloride (HDPE)
SEW-2.0SP-D	2.0S		1	

# SLEEVE COVER

Plastic cover for FULL BLOW CUPLA

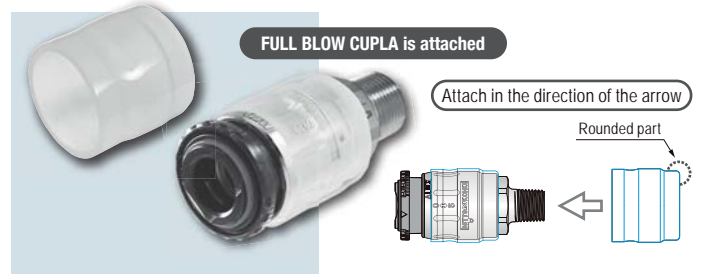

- Easier sliding operation is achieved by attaching an additional plastic cover over the socket sleeve of FULL BLOW CUPLA.
- Plastic covers reduce the risk of damage if CUPLA strikes other components or products.

Model	Color	Applicable CUPLA	Sales unit	Material
SLEEVE COVER SLC-FBH	Semitransparent	FULL BLOW CUPLA	1	Polyvinyl chloride (PVC)

# PROTECTION COVER

Plastic Cover for NUT CUPLA and FULL BLOW CUPLA Nut Type (Semitransparent)

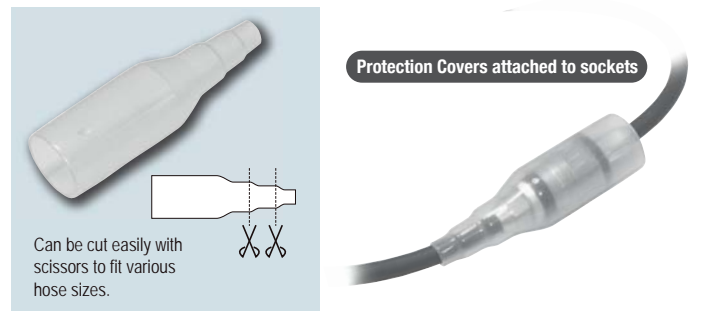

- Protection cover wraps up whole CUPLA to absorb impacts and to reduce the risk of damage if CUPLA accidentally strikes other components or products.
- Protection covers can be cut to fit the hose diameter of the hose.
- Can be attached to either the socket or the plug, and can be used as a dust cap.

Part number	Model	Applicable CUPLA	Sales unit	Material
CB23784	SOC-HI	Can be attached to NUT CUPLA socket or plug (SN type & PN type) and FULL BLOW CUPLA (SN Type).	1	Polyvinyl chloride (PVC)

# SLEEVE STOPPER

Sleeve Stopper for SP CUPLA Type A and SP-V CUPLA Type A

- Sleeve stopper exclusively for SP CUPLA Type A and SP-V CUPLA Type A sockets. Attaching the sleeve stopper after connection of socket and plug locks the sleeve of the socket and prevents unexpected disconnection.

Attached to SP CUPLA Type A



Socket	Part number	Stopper for SP CUPLA Type A socket	Applicable CUPLA	Sales unit	Material	Socket	Part number	Stopper for SP CUPLA Type A socket	Applicable CUPLA	Sales unit	Material
	CB24350	For 1S					SP CUPLA Type A, SP-V CUPLA Type A and SP CUPLA Type A PV Type sockets	10			
CB24351	For 2S	10	CB26457	For 12S	1						
CB24352	For 3S	10	CB26458	For 16S	1						
CB24353	For 4S	10									
CB24354	For 6S	10									
CB24355	For 8S	10									

# ACCESSORIES FOR O-RING MAINTENANCE

Jigs & grease for replacement of O-rings for couplings For SP CUPLA Type A, TSP CUPLA, HOT WATER CUPLA, ZEROSPILL CUPLA, HSP CUPLA, HSU CUPLA and HYGIENIC CUPLA

- The seal materials play an important role in maintaining the performance of a coupling. O-rings or seal materials of these CUPLA series are designed to be replaceable. Please be certain to choose the correct and genuine Nitto kohki O-ring in order to maintain the performance of couplings.

Jig for O-ring replacement

- Model: **PMJ-1 (Small)** (Part.No.CB23687)  
• Sales unit: 1 pc.
- Model: **PMJ-2 (Large)** (Part.No.CB23688)  
• Sales unit: 1 pc.

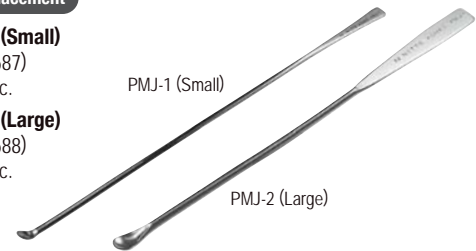

5 mL container  
**Grease for CUPLA**  
• **GRE-HC1 (Hydrocarbon grease)** for NBR, FKM O-ring or packing (Part.No.CB28531)  
• Sales unit: 1 pc.

5 mL container  
**Grease for CUPLA**  
• **GRE-M1 (Mineral grease)** for NBR, FKM O-ring or packing (Part.No.CB23701)  
• Sales unit: 1 pc.

5 mL container  
**Grease for CUPLA**  
• **GRE-S1 (Silicone grease)** for NBR, FKM, and EPDM O-ring or packing (Part.No.CB23702)  
• Sales unit: 1 pc.

5 mL container  
**Grease for CUPLA**  
• **GRE-S2 (Silicone grease)** for NBR, FKM, and EPDM O-ring or packing (Part.No.CB28791)  
• Sales unit: 1 pc.  
(NSF H1, NSF 61 registered product)  
Standardly applied to CUBE CUPLA

5 mL container  
**Grease for CUPLA**  
• **GRE-S3 (Silicone grease)** for NBR, FKM, and EPDM O-ring or packing (Part.No.CB66292)  
• Sales unit: 1 pc.  
Standardly applied to FLOW MONITOR

O-ring for SP CUPLA Type A	Part number			Sales unit
	NBR	FKM	EPDM	
For 1S-A	CP01314	CP2B070	CP03270	1
For 2S-A	CP00927	CP2B071	CP03333	1
For 3S-A	CP00955	CP2B072	CP03276	1
For 4S-A	CP00978	CQ00420	CP03283	1
For 6S-A	CP01003	CQ48744	CP03292	1
For 8S-A	CP01029	CP01030	CP03298	1
For 10S-A	CP00398	CP01053	CP07179	1
For 12S-A	CP01076	CP01077	CP03902	1
For 16S-A	CP01099	CP01100	CP06953	1

O-ring for TSP CUPLA	Part number			Sales unit
	NBR	FKM	EPDM	
For 1TS	CP03987	CP04984	CP09795	1
For 2TS	CP01314	CP2B070	CP03270	1
For 3TS	CP00927	CP2B071	CP03333	1
For 4TS	CP00955	CP2B072	CP03276	1
For 6TS	CP00978	CQ00420	CP03283	1
For 8TS	CP00387	CP01258	CP04923	1
For 10TS	CP01273	CP01274	CP09221	1
For 12TS	CP00398	CP01053	CP07179	1
For 16TS	CP01304	CP01305	CP09794	1

O-ring for HSP CUPLA	Part number		Sales unit
	NBR	FKM	
For 2HS	CP01185	CP02215	1
For 3HS	CP01194	CP03335	1
For 4HS	CP00294	CP02093	1
For 6HS	CP00294	CP02093	1
For 66HS	CQ33388	CP25937	1
For 8HS	TP00293	CP01179	1
For 10HS	CP01516	CP03371	1
For 12HS	CP01516	CP03371	1
For 16HS	CP03035	CP03453	1

Backup ring for HSP CUPLA	Part number	Sales unit
	PTFE	
For 2HS	CP01186	1
For 3HS	CP01195	1
For 4HS	CP01203	1
For 6HS	CP01203	1
For 66HS	CP09659	1
For 8HS	CP01211	1
For 10HS	CP01517	1
For 12HS	CP01517	1
For 16HS	CP03036	1

O-ring for ZEROSPILL CUPLA	Part number			Sales unit
	NBR	FKM	EPDM	
For ZEL-2S	CQ40611	CQ40740	CQ43755	1
For ZEL-3S	CQ40628	CQ40744	CQ43757	1
For ZEL-4S	CQ40645	CQ40748	CQ43759	1
For ZEL-6S	CQ40662	CQ40752	CQ43761	1
For ZEL-8S	CQ40679	CQ40756	CQ43763	1

O-ring for HSU CUPLA	Part number	Sales unit
	HNBR	
HSU-2S	CQ42490	1
HSU-3S	CQ42496	1
HSU-4S	CQ42502	1
HSU-6S	CQ43482	1
HSU-8S	CQ43489	1

Backup ring for HSU CUPLA	Part number	Sales unit
	PTFE	
HSU-2S	CP25269	1
HSU-3S	CQ42497	1
HSU-4S	CQ13520	1
HSU-6S	CQ26486	1
HSU-8S	CP20780	1

O-ring for HOT WATER CUPLA	Part number	Sales unit
	FKM	
HW-2S-F	CB64216	2
HW-3S-F	CB64217	2
HW-4S-F	CB64218	2

O-ring for HYGIENIC CUPLA	Part number			Sales unit
	SI	FKM	EPDM	
SEW-1.5P	CB63419	CB63420	CB63421	1
SEW-2.0P	CB62939	CB62940	CB62941	1

• See page 188 for replacement of the O-ring.



# RESIDUAL PRESSURE RELEASE JIG

Residual Pressure Release Metal Jig for SP CUPLA Type A and HYDRAULIC CUPLA (Semi-standard)

- Residual pressure within socket or plug can be released easily by just turning the handle.
- Residual pressure release jigs are available in two types; socket type for use with plugs and plug type for use with sockets.
- Connection to sockets or plugs is the same as connection of normal CUPLA.



The photos show the jigs for HSP CUPLA.

Model	Attachable CUPLA	Sales unit
The model name is to be defined in the following manner. <b>Z N</b> – Type of CUPLA to be attached Residual pressure release jig	Example: For CUPLA model 350-3S, the jig name would be <b>ZN-350-3S</b> Sockets and plugs for SP CUPLA Type A, HSP CUPLA, 210 CUPLA, S210 CUPLA, 280 CUPLA and 350 CUPLA	1 pc.

Caution: Since the upper limit of residual pressure that can be relieved depends on the product, please contact us separately.

# CUPLA ADAPTER for Braided Hose Connection

Mounts on CUPLA plug / socket with female thread

- Adapter for CUPLA with female thread such as ZEROSPILL CUPLA and SP CUPLA Type A.
- No hose clamp is required resulting in reduced risk of injuries to fingers or palms.
- Deterioration of the braided hose at the hose barb part has been eliminated.
- Unique nut construction increases the pulling load of braided hoses.
- Simply push a braided hose onto the hose barb to the end and tighten the nut until it is flush against the hose barb base.
- No inner parts for conventional braided hose fittings are required. Thus incorrect assembling does not occur.

A tool and a hose clamp are not required.



Not Required



Application Example

Can be mounted on the plug and socket of ZEROSPILL CUPLA.

Benefits without a hose clamp

Two piece design

Please use braided hoses available in the market.

### Specifications

Body material	Brass			
Model	BH90-3M	BH120-4M	BH150-4M	BH190-6M
Size (Thread)	3/8"	1/2"	1/2"	3/4"
Braided hose size	ø9×ø15 mm	ø12×ø18 mm	ø15×ø22 mm	ø19×ø26 mm
Working pressure <sup>*1</sup>	Depends upon the specifications of braided hoses to be used.			
Working temperature range <sup>*1</sup>	Depends upon the specifications of braided hoses to be used.			
Applicable fluids <sup>*2</sup>	Air, Water, Oil			

### Maximum Tightening Torque

Nm {kgf·cm}

Model	BH90-3M	BH120-4M	BH150-4M	BH190-6M
Torque (Taper Pipe Threads) <sup>*3,4</sup>	12 {122}	30 {306}	30 {306}	50 {510}

<sup>\*1</sup>: Max working pressure and working temperature depend upon the specifications of braided hoses to be used.  
<sup>\*2</sup>: Use within the specification of the seal material and the braided hose to be used.  
<sup>\*3</sup>: Stress corrosion crack may happen if they are used under corrosive environment. Take note of usage conditions.  
<sup>\*4</sup>: Tighten the nut until it is flush against the hose barb base after pushing a braided hose to the end.  
 - Braided hoses should be made of soft PVC and woven by reinforcement thread.

### Models and Dimensions

WAF : WAF stands for width across flats.

#### BH-M type (Male thread)

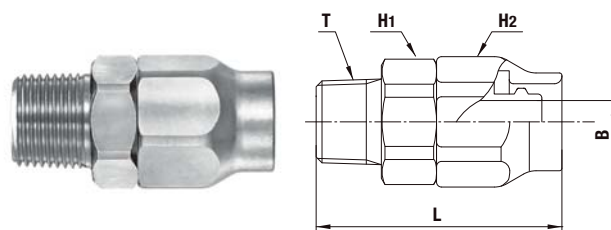

Model	Application (Hose) (mm)	Hose wall thickness (mm)	Mass (g)	Dimensions (mm)				
				L	H1 (WAF)	H2 (WAF)	T	øB
BH90-3M	ø9×ø15	3±0.3	106	(49)	Hex.23	Hex.24	R 3/8	8.5
BH120-4M	ø12×ø18	3±0.3	159	(59)	Hex.27	Hex.27	R 1/2	11
BH150-4M	ø15×ø22	3.5±0.35	210	(67)	Hex.30	Hex.30	R 1/2	13
BH190-6M	ø19×ø26	3.5±0.35	301	(74)	Hex.35	Hex.35	R 3/4	17

# FLOW MONITOR

**NEW**

Replaceable Flow Vane type

For low pressure / For checking the water flow of mold cooling water pipes

- Fluid flow from low flow rate (2 L/min) water pipes can be visually checked with the rotating two-colored impeller.
- Flow Vane ASSY can be replaced without removing it from the piping.
- The stopper prevents unintended removal of the plastic parts.
- Installation and replacement is easy since the screw part of the T2 side rotates freely to the left and right.

\* This product cannot be used for gases. If oil is used for the fluid, the durability may be reduced depending on the compatibility of the oil or additive with the plastic parts.

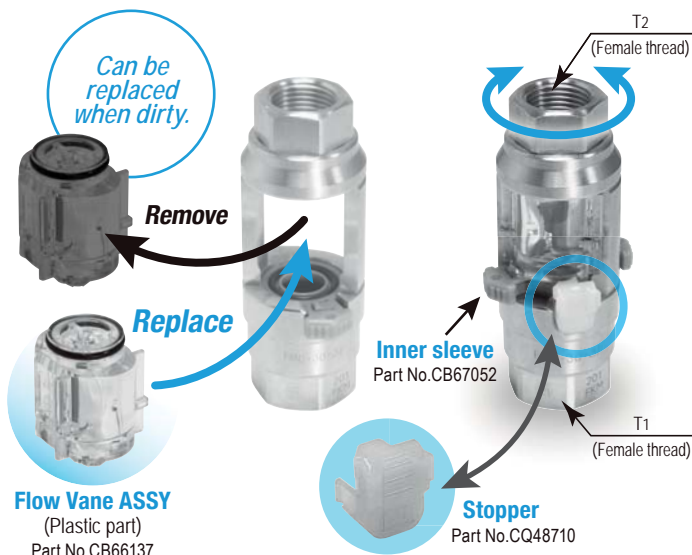
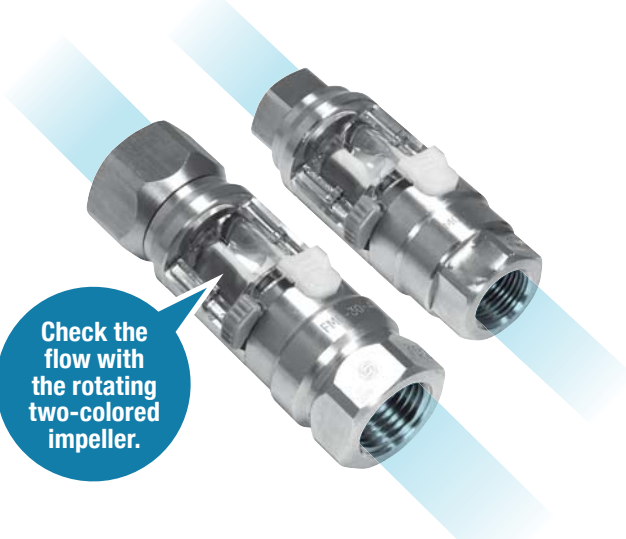

**Flow Vane ASSY**  
(Plastic part)  
Part No. CB66137

**Stopper**  
Part No. CQ48710

### Recommended replacement time of Flow Vane ASSY



**Flow Vane ASSY**

If the Flow Vane ASSY is dirty or cloudy and the impeller is difficult to see, replace it regardless of the recommended replacement time.

The recommended replacement time for this product is calculated from the amount of wear on the internal parts of the Flow Vane ASSY based on long-term flow durability tests. Refer to the table below for the recommended replacement time.

\* The durability varies depending on the usage environment and conditions. (pressure, temperature, etc.)

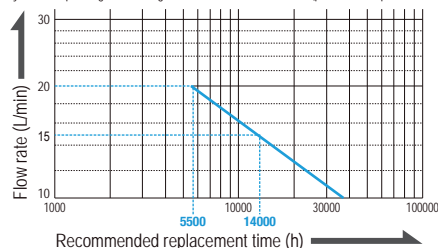

Specifications				
Model	FMC-30-3F		FMC-30-4F	
Size (Thread)	Rc 3/8		Rc 1/2	
Body material	Brass			
Flow Vane ASSY material (Plastic part)	Outer cylinder	Polycarbonate		
	Impeller	Polypropylene		
	Inner sleeve, Stopper	Polyamide		
Pressure unit	MPa	kgf/cm <sup>2</sup>	bar	PSI
Working pressure	1.0	10	10	145
Working flow range	L/min	2 to 20		
Seal material	Fluoro rubber	Mark	FKM	Working temperature range
Working temperature range <sup>*1</sup>	+10°C to +80°C			

\*1: The operable temperature range depends on the operating conditions.

Maximum Tightening Torque		Nm {kgf·cm}	
Size (Thread)	Rc 3/8	Rc 1/2	
Torque	12 {122}	30 {306}	



### Flow Rate – Pressure Loss Characteristics

[Test conditions] - Fluid : Water - Temperature : 23°C

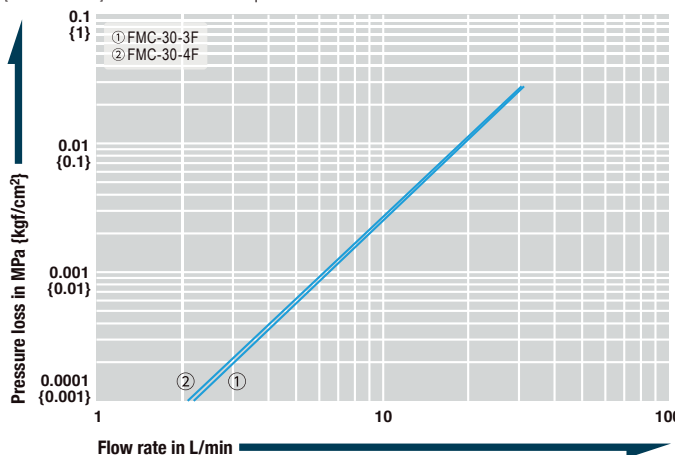

### Models and Dimensions

WAF : WAF stands for width across flats.

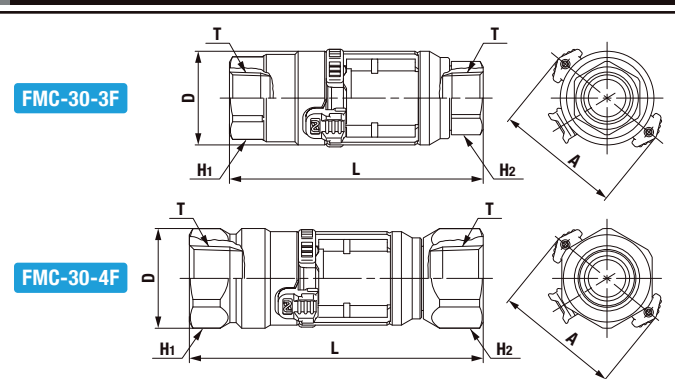

Model	Application	Mass (g)	Dimensions (mm)					
			L	øD	H1 (WAF)	H2 (WAF)	T	A
FMC-30-3F	R 3/8	167	(81)	30	Hex.24	Hex.21	Rc 3/8	(40)
FMC-30-4F	R 1/2	256	(94)	32	Hex.29	Hex.29	Rc 1/2	(40)

# FLOW METER

For low pressure / Flow meter with special valve for mold cooling lines

- Graduated scale shows the coolant flow rate numerically, thus reducing operator variation in setting cooling conditions.
- Although small, it has a built-in flow rate adjustment valve, allowing the molding conditions of each machine to be set freely.
- Molding conditions are reproducible and lead time can be shortened.
- Installation and replacement is easy since the screw part of the T2 side rotates freely to the left and right.

Note: Plastic part (Scale tube) cannot be replaced

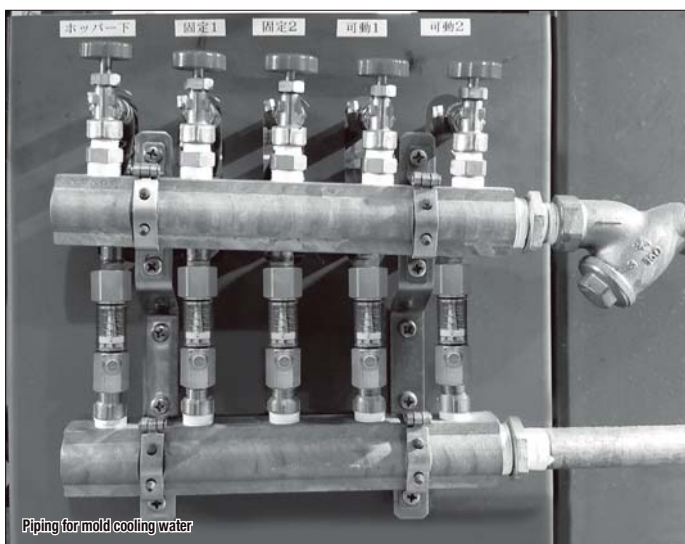

## Specifications

Body material	Brass			
Graduated tube (Scale tube)	Polycarbonate			
Size (Thread)	Both ends Rc 3/8 female thread			
Pressure unit	MPa	kgf/cm <sup>2</sup>	bar	PSI
Working pressure	0.5	5	5	72.5
Maximum flow rate	18 L/min (5 to 18 L/min adjustable)			
Seal material	Seal material	Mark	Working temperature range	Remarks
Working temperature range *1	Nitrile rubber	NBR	+10°C to +60°C	Standard material

\*1: The operable temperature range depends on the operating conditions.

## Maximum Tightening Torque

Nm {kgf·cm}

Torque	11 {112}
--------	----------

## Flow Direction

Fluid must flow in the direction of the arrows.



## Pressure - Flow Characteristics

[Test conditions] - Fluid : Water - Temperature : 23°C±5°C

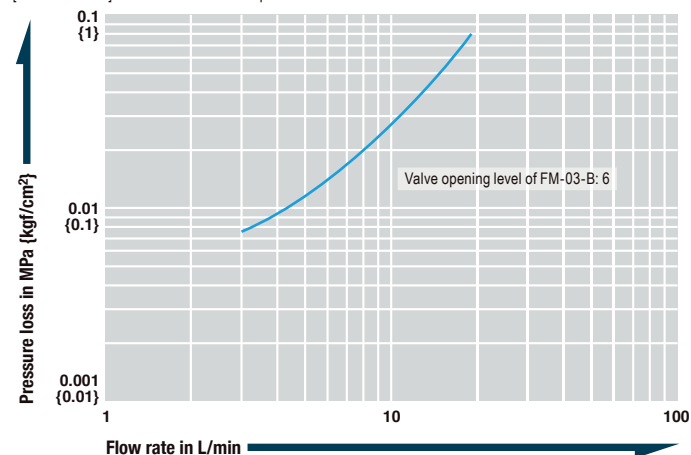

## Models and Dimensions

WAF : WAF stands for width across flats.

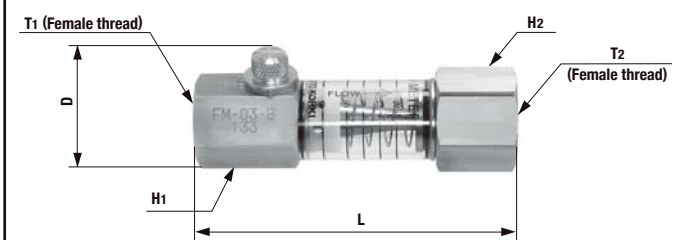

Model	Mass (g)	Dimensions (mm)					
		L	D	H1 (WAF)	H2 (WAF)	T1	T2
FM-03-B	190	(89)	(33)	Hex.23	Hex.26	Rc 3/8	Rc 3/8

# PURGE ADAPTER

Residual Pressure Purge Adapter for Hydraulic Lines

- Can be attached to hydraulic lines to purge residual pressure effectively.

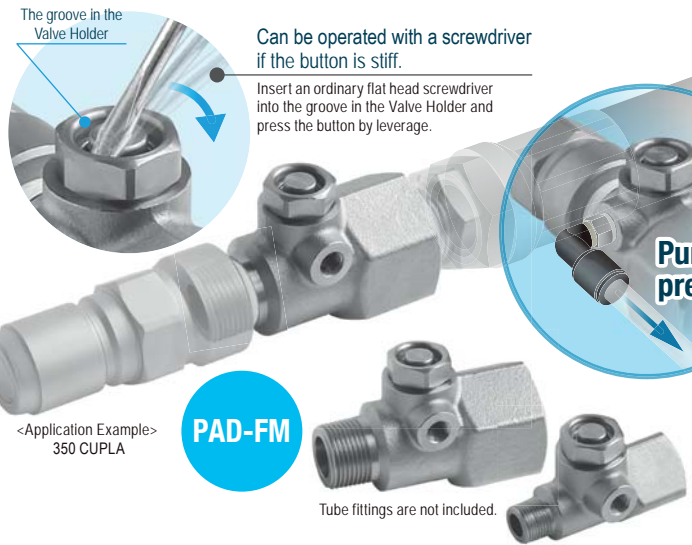

## Residual Pressure Purge Speed Comparison

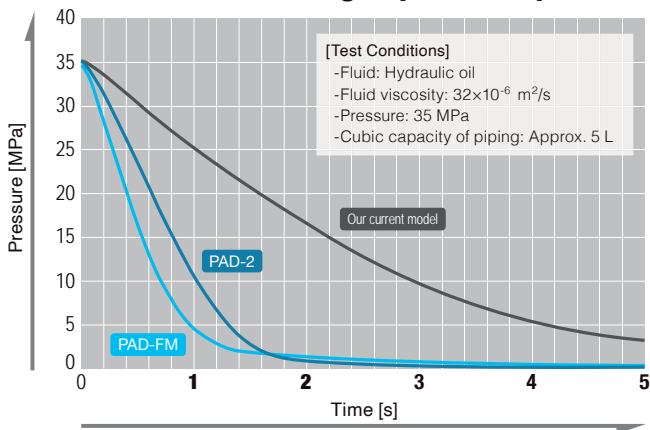

Specifications					
Model	PAD-2	PAD-3FM	PAD-4FM	PAD-6FM	PAD-8FM
Body material	Steel (Nickel plated)				
Application	R 1/4	R 3/8 × Rc 3/8	R 1/2 × Rc 1/2	R 3/4 × Rc 3/4	R 1 × Rc 1
Pressure unit	MPa	kgf/cm <sup>2</sup>	bar	PSI	
Working pressure	35.0	357	350	5080	
Drain outlet port	For 8 mm OD tube	Application: Rc 1/8 (Max. Tightening Torque: 5 Nm)			
Applicable fluids	Hydraulic oil				
Seal material	Seal material	Mark	Working temperature range	Remarks	
Working temperature range <sup>*1</sup>	Nitrile rubber	NBR	-5°C to +80°C	Standard material	

\*1: The operable temperature range depends on the operating conditions.

Maximum Tightening Torque		Nm (kgf·cm)				
Size (Thread)	R 1/4	R 3/8 × Rc 3/8	R 1/2 × Rc 1/2	R 3/4 × Rc 3/4	R 1 × Rc 1	
Torque	28 (286)	40 (408)	80 (816)	150 (1530)	250 (2550)	

Minimum Cross-Sectional Area		(mm <sup>2</sup> )				
Model	PAD-2	PAD-3FM	PAD-4FM	PAD-6FM	PAD-8FM	
Minimum Cross-Sectional Area	-	78.5 ( $\phi 10$ )	122 ( $\phi 12.5$ )	213 ( $\phi 16.5$ )	363 ( $\phi 21.5$ )	

**Suitability for Vacuum**  
Not suitable for vacuum application.

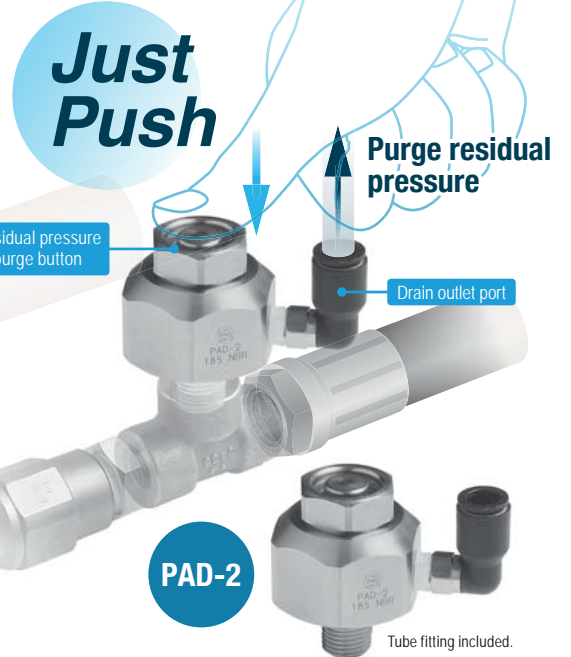

## Models and Dimensions

WAF : WAF stands for width across flats.

PAD-2 Female thread								
Model	Mass (g)	Dimensions (mm)						
PAD-2	235	L1	$\phi D$	P1	P2	H (WAF)	T1	$\phi T2$
		(62)	39.5	(48)	14	Hex.36	R 1/4	8

PAD-3FM / PAD-4FM For thread connection											
Model	Mass (g)	Dimensions (mm)									
PAD-3FM	320	L1	L2	L3	B	$\phi D$	P1	P2	H (WAF)	T1	T2
PAD-4FM	307	72.5	(39)	21.5	(11)	10	(51)	(33.5)	□29	R 3/8	Rc 3/8
										R 1/2	Rc 1/2

PAD-6FM / PAD-8FM For thread connection											
Model	Mass (g)	Dimensions (mm)									
PAD-6FM	665	L1	L2	B	$\phi D$	P1	P2	H (WAF)	T1	T2	
PAD-8FM	620	86	21.5	(15.5)	16.5	(63.5)	(38)	Hex.46	R 3/4	Rc 3/4	
									R 1	Rc 1	



# CUPLA CONNECTING JIG

Connecting Jig for large CUPLA

- Smooth and easy connection of large CUPLA by operating a lever.



### Versatile

Corresponds to all applicable models\*1 by adjusting the body length.

\*1: Standard CUPLA appearing in the CUPLA general catalog (two-way shut-off valve). Except MULTI CUPLA series. See below list of applicable models.

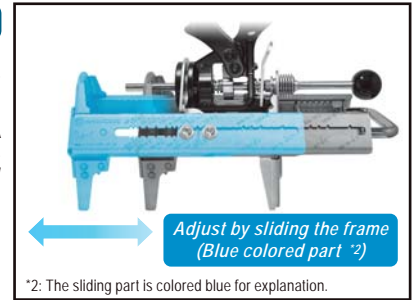

\*2: The sliding part is colored blue for explanation.

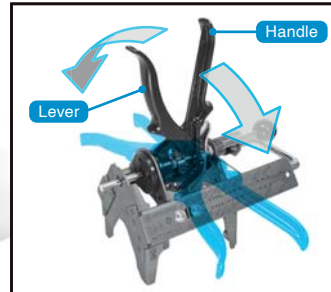

### Functional

The Handle can be used at any angle to prevent interference with CUPLA.

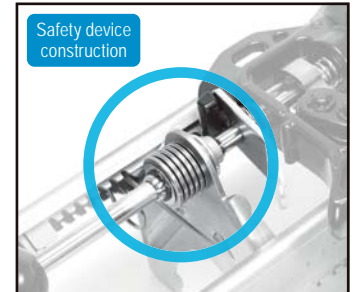

### Safe

If excessive force occurs during connection, the safety device prevents damage to the body. When the safety device is activated, the connection of CUPLA is disabled.

### Specifications

Model	CJ-1
Body material	Stainless steel (SUS430), Aluminum alloy
Applicable CUPLA	See list on the right
Connection under residue pressure	Not possible
Working temperature	Normal temperature
Storage Temperature Range	-20°C to +60°C
Mass	1.85 kg
Accessories	4 mm Hexagon wrench, Operation procedure tag, Cable tie

This is a product that assists connection of CUPLA. If an excessive load is applied during connection, such as when the O-ring is insufficiently lubricated, when the O-ring is hardened in a low temperature environment, or when CUPLA is under dynamic pressure or residual pressure, the safety device activates and will not connect. Be sure to check with the actual product before use.

### List of Applicable Models

Applicable models	Size (Thread)			
	Rc 1	Rc 1 1/4	Rc 1 1/2	Rc 2
SP CUPLA Type A	8SP-A	10SP-A	12SP-A	16SP-A
ZEROSPILL CUPLA	ZEL-8SP	-	-	-
HSP CUPLA	8HSP	10HSP	12HSP	16HSP
210 CUPLA	210-8SP	-	-	-
HSU CUPLA	HSU-8SP	-	-	-
S210 CUPLA	S210-8SP	-	-	-
280 CUPLA	280-8SP	-	-	-
350 CUPLA	350-8SP	350-10SP	350-12SP	-
FLATFACE CUPLA F35	F35-8SP	-	-	-
FLATFACE CUPLA FF	FF-8SP	-	-	-
SEMICON CUPLA SP Type	8SP-304	-	-	-
SEMICON CUPLA SCS Type	SCS-8P	-	-	-
SEMICON CUPLA SCY Type	SCY-8S	-	-	-
SEMICON CUPLA SCT Type	SCT-8SP	-	-	-
SEMICON CUPLA SCAL Type	SCAL-8SP	-	SCAL-12SP	-

### Models and Dimensions

#### Model: CJ-1

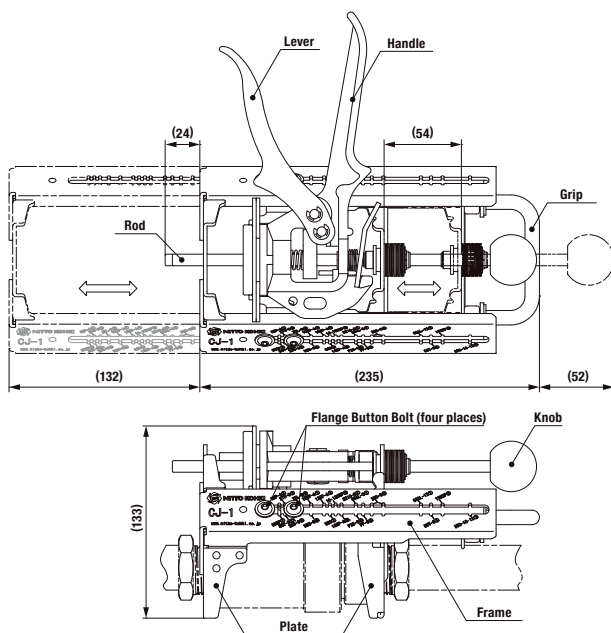

(Note) When the Handle is perpendicular to the body, it may interfere with CUPLA and will not be able to be used. In this case, tilt the handle to a convenient angle for use.

### Connection of large CUPLA with Lever operation

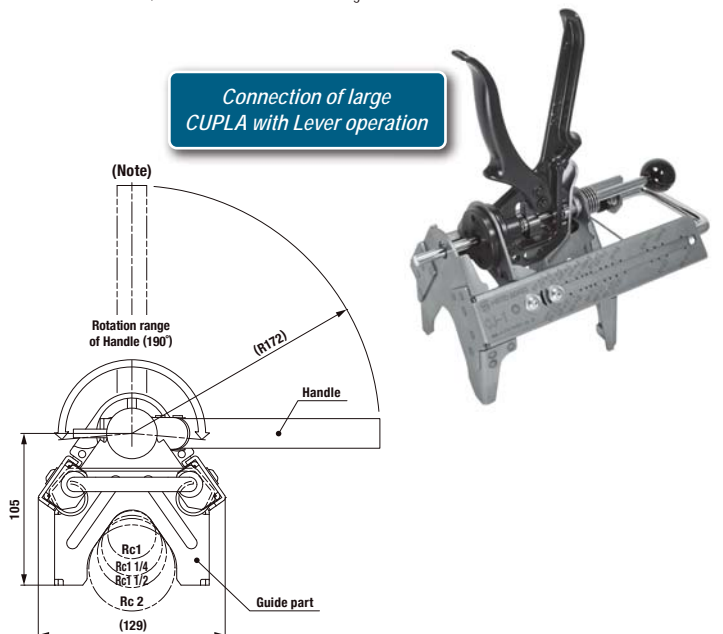

\* To prevent injuries, it is recommended to wear gloves during use.

(mm)



# Seal Material Selection Table for Reference

For seal parts in CUPLA (the important parts that prevent leaking to the outside), it is important to select the most appropriate seal material to suit the property and temperature of the fluid. It is so important that wrong selection may not only impair the function of CUPLA but also cause an unexpected accident.

When the fluid in question is not listed in "Seal Material Selection Table (For reference)," the seal material that you select should be tested under actual environment. Even if the fluid is stated in the following list, the test could be required in some cases.

	Fluids	Seal Material						
		Nitrile rubber	Hydrogenated nitrile rubber	Ethylene-propylene rubber	Fluoro rubber	Perfluoro-elastomer	Silicone rubber	Chloroprene rubber
2	2,2-Dimethyl-butane	○	○	×	○	○	×	△
	2,3-Dimethyl-butane	○	○	×	○	○	×	△
	2,4-Dimethyl-pentane	○	○	×	○	○	×	×
	2-Methyl-pentane	○	○	×	○	○	×	×
3	3-Methyl-pentane	○	○	×	○	○	×	×
A	Acetaldehyde	△	△	○	×	△	○	△
	Acetic acid	○	○	○	△	○	△	○
	Acetic anhydride	△	×	○	×	○	○	○
	Acetone	×	×	○	×	○	×	×
	Acetonitrile	×		×	△	○	×	×
	Acetophenone	×	×	○	×	○	×	×
	Acetyl chloride	×	×	×	○	○	×	×
	Acetylacetone	×	×	○	×	○	×	×
	Acetylene	○	○	○	○	○	○	○
	Air (50°C)	○	○	○	○	○	○	○
	Aluminium bromide	○	○	○	○	○	○	○
	Aluminium chloride	○	○	○	○	○	○	○
	Aluminium nitrate	○	○	○	○	○	○	○
	Aluminium sulfate	○	○	○	○	○	○	○
	Amine mixture	×	×	○	×	×	○	○
	Ammonia (anhydrous)	○	○	○	×	○	○	○
	Ammonia (Liquid) (65°C)	△			×	○		△
	Ammonia (Liquid) (Cool)	△		○	×	○	○	○
	Ammonia gas (Low temperature)	○	○	○	×	○	○	○
	Ammonium carbonate	×	×	○	○	○	×	○
	Ammonium chloride	○	○	○	○	○	×	○
	Ammonium hydroxide	×	×	○	×	×	○	△
	Ammonium magnesium sulfate	×		×	×		×	×
	Ammonium nitrate (65°C)	○	○	○			○	○
	Ammonium phosphate (65°C)	○		○	×	○	○	○
	Ammonium sulfate	○	○	○	×	○	○	○
	Ammonium sulfite	△	△	○	△	○	○	○
	Ammonium thiosulfate	△	△	○	△	○	○	○
	Amyl acetate	×	×	△	×	○	×	×
	Amyl alcohol	○	○	○	○	○	×	○
	Aniline	×	×	○	△	○	×	×
	Animal oil (Lard)	○	○	○	○	○	○	○
	Arsenic trichloride	△		×	×	○	×	×
	Asphalt	○	○	×	○	○	×	×
	B	Barium chloride	○	○	○	○	○	○
		Barium hydroxide	○	○	○	○	○	○
		Barium nitrate	△	△	○	△	○	○
		Barium sulfate (65°C)	○		○	○	○	○
		Barium sulfide	○	○	○	○	○	○
		Beer	○	○	○	○	○	○
		Benzaldehyde	×	×	○	×	○	×
		Benzene	×	×	×	○	○	×
		Benzyl alcohol	×	×	○	○	△	○
		Benzyl chloride	×	×	×	○	○	×
		Brake oil	△	△	○	×	△	○
		Bromine	×	×	×	○	○	×
		Bromine water	×	×	×	○	○	×

	Fluids	Seal Material							
		Nitrile rubber	Hydrogenated nitrile rubber	Ethylene-propylene rubber	Fluoro rubber	Perfluoro-elastomer	Silicone rubber	Chloroprene rubber	
B	Butadiene	×	×	×	○	○	×	×	
	Butane	○	○	×	○	○	×	△	
	Butane (liquid)	○		×	○		×	○	
	Butanol (Butyl alcohol)	○	○	○	○	○	○	○	
	Butter and butter oil	○	○	○	○	○	○	×	
	Butyl acetate	×	×	○	×	○	×	×	
	Butyl stearate	○	○	×	○	○	×	×	
	Butylaldehyde	×	×	○	×	○	×	×	
	Butylene	○	○	×	○	○	×	△	
	C	Cadmium cyanide	△	△	○	△	○	○	○
		Calcium acetate	○	○	○	×	○	×	○
		Calcium acetate (65°C)	○		○	×	○	×	○
		Calcium carbide					○		
Calcium carbonate		○	○	○	○	○	○	○	
Calcium hydroxide		○	○	○	○	○	○	○	
Calcium nitrate (65°C)		○		○	○	○	○	○	
Calcium perchlorate		×		×	×		×	×	
Calcium sulfate		△	△	○	△	○	○	○	
Calcium sulfate (65°C)		×		○	△	○	○	○	
Calcium sulfite		○	○	○	○	○	○	○	
Carbitol		○	○	○	○	○	○	○	
Carbon dioxide gas (65°C)		○		○	○		○	○	
Carbon disulfide		×	×	×	○	○	×	×	
Carbon monoxide (65°C)		○	○	○	○	○	○	○	
Carbon tetrachloride		○	○	×	○	○	×	×	
Castor oil		○	○	○	○	○	○	○	
Chlorine (liquid)		×		×	×	○	×	×	
Chlorine gas		○	○	×	○	○	×	×	
Chlorine water		△	△	○	○	○	×	×	
Chloroacetone		×	×	○	×	○	×	×	
Chlorobenzene		×	×	×	○	○	×	×	
Chloroform		×	×	×	○	○	×	×	
Chlorophenol		×	×	×	○	○	×	×	
Chromium hydroxide						○			
Coconut oil		○	○	△	○	○	○	×	
Cod liver oil		○		○	○	○	○	○	
Coffee	○		×	×		×	×		
Copper chloride	○	○	○	○	○	○	○		
Copper cyanide	○	○	○	○	○	○	○		
Copper sulfate	○	○	○	○	○	○	○		
Corn oil	○	○	△	○	○	○	△		
Cotton seed oil	○	○	△	○	○	○	△		
Gresol (50°C)	×	×	×	○	○	×	×		
Crude oil	○	○	×	○	○	×	×		
Cyclohexane	○	○	×	○	○	×	×		
Cyclohexanol	○	○	×	○	○	×	×		
D	Developer	○	○	○	○	○	○		
	Diacetone alcohol	×	×	○	×	○	×		
	Dibenzyl ether	×	×	○	×	○	×		
	Dichlorophenol	○	○	×	○	○	×		
	Diesel oil	○	○	×	○	○	×		
	Diethanolamine	△	△	○	△	○	○		

# Seal Material Selection Table for Reference

## How to read the selection tables

- ⊙ Practically no harm, and can be used (Excellent)
- Some harm may be inevitable but can be used under restrictions (Good)
- △ Should be avoided if at all possible (Not recommended)
- × Should not be used (Unsuitable)

**Note:** When selecting the seal material, please consider the following suggestions carefully:

1. If there is no comment in the column of the fluid name, the condition of the fluid is under saturation at room temperature.
2. Please check with us for applications at a high fluid temperature or with different fluid concentrations.
3. For applications related to foods, please order separately specifying the detailed applications.

Note: Contact us when the space is blank.

	Fluids	Seal Material							
		Nitrile rubber	Hydrogenated nitrile rubber	Ethylene-propylene rubber	Fluoro rubber	Perfluoro-elastomer	Silicone rubber	Chloroprene rubber	
<b>D</b>	Diethylene glycol	⊙	⊙	⊙	⊙	⊙	○	⊙	
<b>E</b>	Ethanol (Ethyl alcohol)	△	△	⊙	△	⊙	○	⊙	
	Ethyl acetate	×		○	×		○	×	
	Ethyl benzene	×	×	×	⊙	⊙	×	×	
	Ethyl cellulose	○	○	○	×	⊙	○	○	
	Ethyl chloride	⊙	⊙	△	⊙	⊙	×	×	
	Ethylene glycol	⊙	⊙	⊙	⊙	⊙	⊙	⊙	
	Ethylene trichloride	×	×	△	⊙	⊙	×	×	
	<b>F</b>	Ferric sulfate	⊙	⊙	⊙	⊙	⊙		⊙
Fish oil		○	○	×	⊙	⊙	⊙	×	
Fluorine (Gas)		×		×	×	○	×	×	
Formic aldehyde		△	△	○	×	⊙	○	△	
Freon 11		○	×	×	○	○	×	×	
Freon 12		⊙	○	△	△	○	×	⊙	
Freon 22		×	×	△	×	⊙	×	⊙	
Fuel oil		⊙		×	⊙	⊙	×	○	
Furfural		×	×	○	×	⊙	×	×	
<b>G</b>		Gasoline	⊙	⊙	×	⊙	⊙	×	×
		Gelatin	⊙	⊙	⊙	⊙	⊙	⊙	⊙
	Glucose	⊙	⊙	⊙	⊙	⊙	⊙	⊙	
	Glycerine (65°C)	⊙	⊙	⊙	⊙	⊙	⊙	⊙	
	Grease (Petroleum-based)	⊙	⊙	×	⊙	⊙	×	×	
	<b>H</b>	Helium	⊙	⊙	⊙	⊙	⊙	⊙	⊙
Heptane (n-heptane)		⊙	⊙	×	⊙	⊙	×	○	
Hexane (n-hexane)		⊙	⊙	×	⊙	⊙	×	○	
Hexylene glycol		△	△	⊙	△	⊙	○	⊙	
Hydraulic oil (Petroleum-based)		⊙	⊙	×	⊙	⊙	○	×	
Hydraulic oil (Phosphate ester series)		×	×	○	⊙	⊙	△	×	
Hydraulic oil (Synthetically-prepared)		○	○	×	⊙	⊙		×	
Hydraulic oil (Water-glycol series)		⊙	⊙	⊙	○	⊙	○	⊙	
Hydraulic oil (Water-in-oil emulsion series)		⊙	⊙	×	⊙	⊙	△	×	
Hydrobromic acid		×	×	⊙	⊙	⊙	×	×	
Hydrogen		⊙	⊙	⊙	⊙	⊙	△	⊙	
Hydrogen peroxide (30%)		×			⊙	⊙		×	
<b>I</b>		Iron chloride	⊙		⊙	⊙		○	⊙
		Iron nitrate (65°C)	⊙		⊙	⊙		○	⊙
	Iron sulfite (100%)	⊙		×	×		×	×	
	Isoamyl alcohol	×		×	×		×	×	
	Isooctane	⊙	⊙	×	⊙	⊙	×	○	
	Isopropanol	○	○	⊙	⊙	⊙	⊙	○	
	Isopropyl acetate	×	×	○	×	⊙	×	×	
	Isopropyl alcohol	○	○	⊙	⊙	⊙	⊙	○	
	Isopropyl ether	○	○	×	×	⊙	×	×	
	<b>K</b>	Kerosene	⊙	⊙	×	⊙	⊙	×	○
<b>L</b>	Lard and lard oil	⊙	⊙	○	⊙	⊙	○	○	
	Latex	×		×	×		×	×	
	Liquefied petroleum gas (LPG)	⊙	⊙	×	⊙	⊙	△	×	
	Liquors (beet)	⊙	⊙	⊙	⊙	⊙	⊙	⊙	
	Lubricating oil (SAE 10, 20, 30, 40, 50)	⊙	⊙	×	⊙	⊙	×	×	
<b>M</b>	Magnesium chloride	⊙	⊙	⊙	⊙	⊙	⊙	⊙	
	Magnesium hydroxide	○	○	⊙	⊙	⊙	×	○	
	Magnesium nitrate	⊙		×	×		×	×	

	Fluids	Seal Material						
		Nitrile rubber	Hydrogenated nitrile rubber	Ethylene-propylene rubber	Fluoro rubber	Perfluoro-elastomer	Silicone rubber	Chloroprene rubber
<b>M</b>	Magnesium sulfate	⊙			⊙	⊙	○	⊙
	Maleic anhydride	×	×	○	×	⊙	×	×
	Mercury	⊙	⊙	⊙	⊙	⊙	×	⊙
	Methanol	×	×	⊙	×	⊙	⊙	⊙
	Methyl bromide	○	○	×	⊙	⊙	×	×
	Methyl butyl ketone	×	×	⊙	×	⊙	×	×
	Methyl chloride	×	×	△	⊙	⊙	×	×
	Methyl ethyl ketone (MEK)	×	×	⊙	×	⊙	×	×
	Methyl isobutyl ketone (MIBK)	×	×	△	×	⊙	×	×
	Methyl propyl ketone	×		○	×		×	×
	Methyl salicylate	×	×	○	×	⊙	×	△
	Methylene bromide	×		×	⊙	⊙	×	×
	Methylene chloride	×		×	○	⊙	×	×
	Milk	⊙	⊙	⊙	⊙	⊙	⊙	⊙
	Mineral oil	⊙	⊙	×	⊙	⊙	△	△
	Monobromobenzene	×		×	⊙	⊙	×	×
	Monochlorobenzene	×	×	×	⊙	⊙	×	×
	Monoethanolamine (MEA)	×	×	○	×	⊙	○	×
<b>N</b>	n-amyl alcohol	×		×	×		×	×
	Naphtha	○	○	×	⊙	⊙	×	×
	Naphthalene	×	×	×	⊙	⊙	×	×
	Naphthenic oil	⊙		×	⊙		×	×
	n-butyl alcohol	×		×	×		×	×
	Nickel acetate	○	○	⊙	×	⊙	×	○
	Nickel acetate (65°C)	×		⊙	×		×	×
	Nickel ammonium sulfate	△		⊙	△	⊙	○	⊙
	Nickel chloride	⊙	⊙	⊙	⊙	⊙	⊙	⊙
	Nickel nitrate	△	△	⊙	△	⊙	○	⊙
	Nickel sulfate	⊙	⊙	⊙	⊙	⊙	⊙	○
	Nitrobenzene	×	×	△	○	⊙	×	×
	Nitrogen (gas)	⊙	⊙	⊙	⊙	⊙	⊙	⊙
	<b>O</b>	Octyl alcohol	○	○	△	⊙	⊙	○
Oleic acid		△	△	×	○	⊙	×	×
Olive oil		⊙	⊙	○	⊙	⊙	△	×
Ortho-dichlorobenzene		×	×	×	⊙	⊙	×	×
Oxygen (gas)		○	○	⊙	⊙	⊙	⊙	○
Ozone		×	△	⊙	⊙	⊙	⊙	×
<b>P</b>		Palm oil	×		×	×		×
	Paradichlorobenzene	×	×	×	⊙	⊙	×	×
	Paraffin oil	⊙	⊙	×	⊙	⊙	×	×
	Peanut oil	⊙		△	⊙		⊙	○
	Pentane (n-pentane)	⊙	⊙	×	⊙	⊙	×	⊙
	Phenol	×	×	×	⊙	⊙	×	×
	Phosphorous oxychloride (dry)	○		⊙	⊙		○	○
	Phosphorous oxychloride (wet)	○		⊙	⊙		○	○
	Phosphorus	×		×	×	⊙	×	×
	Pine oil	○	○	×	⊙	⊙	×	×
	Potassium acetate (65°C)	○	○	⊙	×	⊙	×	○
	Potassium aluminium sulfate	△	△	⊙	△	⊙	○	⊙
	Potassium bicarbonate	△	△	⊙	△	⊙	○	⊙
	Potassium bichromate	⊙		⊙	⊙	⊙	⊙	⊙
	Potassium carbonate	△	△	⊙	△	⊙	○	⊙



# Body Material Selection Table

The selection of appropriate body material for CUPLA is closely related to its usage application, the type of fluid run through, its concentration (%), the pressure, its working environment, etc. So the material must be carefully considered in order to use CUPLA efficiently and obtain its full performance. Since there are some body materials that should not be used with certain fluids, please refer to this table when making your selection.

○:Suitable    △:Not suitable under certain conditions    ×:Unsuitable

	Fluids	Brass	Stainless Steel	Steel	Aluminum	Polypropylene	
A	Acetic acid	×	○		×	△	
	Acetic anhydride	×	○		△	○	
	Acetone	○	○	○	○	△	
	Air	○	○	○	○	○	
	Aluminum fluoride	○	×			○	
	Aluminum chloride	×	×		×	○	
	Aluminum sulfate	×	○			○	
	Ammonia	×	○		×	○	
	Ammonium nitrate	×	○			○	
	Ammonium phosphate	△	○		×	○	
	Ammonium sulfate	△	△		○	○	
	Aniline	×	○		○	△	
	Arsenic acid	△	○		△	○	
	B	Barium chloride	×	×			○
		Barium hydroxide	×	○		×	○
Barium sulfide			○	○		○	
Beer		○	○	△	○	○	
Benzene		×	○	○	○	△	
Benzine		○	○	○	○	△	
Boric acid		△	○		×	○	
Butane		○	○	○		○	
Butyl acetate		○	○	○	○	△	
C		Calcium chloride	○	△		△	○
		Calcium hydroxide	○	○	○	×	○
		Carbon dioxide	○	○	○	○	○
	Carbon disulfide	○	○	○		×	
	Carbon tetrachloride	△	○		×	×	
	Carbonic acid	○	○	○	○	○	
	Chlorine		×			×	
	Chromic acid	×	×		×	×	
	Citric acid	△	○		△	○	
	Cresol acid	○	○	○	△	○	
	D	Diesel fuel	○	○	○	○	△
Dowtherm			○				
Drinking water		△	○			○	
E	Ethanol	○	○	○	○	○	
	Ether	○	○	○	○	△	
	Ethyl acetate	△	○	△	△	△	
	Ethylene chloride						
	Ethylene glycol	○	○	○	○	○	
F	Fatty acid	△	○			×	
	Ferric chloride	×	×		×	○	
	Ferric sulfate	×	△			○	
	Formaldehyde 40%	△	○		△	○	
	Formic acid	×	○		×	○	
	Freon	○	○	○	○	×	
G	Glycerine	○	○	○	○	○	

	Fluids	Brass	Stainless Steel	Steel	Aluminum	Polypropylene	
H	Hexane	○	○		○	△	
	Hydrobromic acid		×		×	○	
	Hydrochloric acid	×	×	×	×	○	
	Hydrofluoric acid	△	×		×	○	
	Hydrogen	○	○	○	○	○	
	Hydrogen peroxide	×	○			○	
	Hydrogen sulfide	△	△			○	
	I	Industrial water	○	○	△		
	J	Jet fuel		○	△		
L	Lactic acid	×	○		×	○	
	Liquefied petroleum gas (LPG)	○	○	○	○	○	
M	Magnesium chloride	×	×		△	○	
	Mercury	×	○	○		○	
	Methyl alcohol	○	○	○	○	○	
N	Naphtha	○	○	○	○	△	
	Naphthalene	○	○	○	○	○	
	Natural gas	○	○	○	○	○	
	Nickel chloride	×	×			○	
	Nitric acid	×	△		×	△	
	Nitrobenzene	△	○	○		×	
O	Octane						
	Oxygen	○	○	○		○	
P	Paraffin	○	○	○			
	Phenol	△	○			○	
	Phosphoric acid	×	○		×	○	
	Potassium chloride	△	△		×	○	
	Potassium hydroxide	△	○		×	○	
	Pure water	△	○			○	
R	Refined gasoline	○	○	○	○	○	
	Refined petroleum	○	○	○	○	○	
S	Salt water	×	△	×	×	○	
	Sodium carbonate	○	○	○	△	○	
	Sodium chloride	△	△	×	×	○	
	Sodium hydroxide (Caustic soda)		△		×	○	
	Sodium nitrate	△	○	○		○	
	Sodium phosphate		△			○	
S	Sodium sulfate	○	○	○	○	○	
	Sulfuric acid	×	×	×	×	△	
	Sulfurous acid	×	△			○	
T	Tannic acid	×	○			○	
W	Wine	○	○		○	○	
Z	Zinc chloride	×	△		△	○	

Notes: 1. Since fluid concentration (%) and conditions of use may affect the performance, detailed study is necessary when choosing materials.

Notes: 2. For the cells that have no symbol marks, please consult us for appropriate body material.

# Unit Conversion Tables

## Length

m	cm	in	ft	yd	km	mile	n-mile
1	$1 \times 10^2$	$3.937 \times 10$	3.281	1.094	1	$6.214 \times 10^{-1}$	$5.400 \times 10^{-1}$
$1 \times 10^{-2}$	1	$3.937 \times 10^{-1}$	$3.281 \times 10^{-2}$	$1.094 \times 10^{-2}$	1.6093	1	$8.690 \times 10^{-1}$
$2.54 \times 10^{-2}$	2.540	1	$8.333 \times 10^{-2}$	$2.778 \times 10^{-2}$	1.852	1.151	1
$3.048 \times 10^{-1}$	$3.048 \times 10$	$1.2 \times 10$	1	$3.333 \times 10^{-1}$			
$9.144 \times 10^{-1}$	$9.144 \times 10$	$3.6 \times 10$	3	1			

## Area

m <sup>2</sup>	in <sup>2</sup>	ft <sup>2</sup>	yd <sup>2</sup>	km <sup>2</sup>	acre	mile <sup>2</sup>	ha
1	$1.550 \times 10^3$	$1.076 \times 10$	1.196	1	$2.471 \times 10^2$	$3.861 \times 10^{-1}$	$1.00 \times 10^2$
$6.452 \times 10^{-4}$	1	$6.944 \times 10^{-3}$	$7.716 \times 10^{-4}$	$4.047 \times 10^{-3}$	1	$1.563 \times 10^{-3}$	$4.047 \times 10^{-1}$
$9.290 \times 10^{-2}$	$1.44 \times 10^2$	1	$1.111 \times 10^{-1}$	2.590	$6.40 \times 10^2$	1	$2.590 \times 10^2$
$8.361 \times 10^{-1}$	$1.296 \times 10^3$	9	1	$1 \times 10^{-2}$	2.471	$3.861 \times 10^{-3}$	1

## Mass (Weight)

kg	gr	oz	lb	t (metric ton)	ltn (long ton)	stn (short ton)
1	$1.543 \times 10^4$	$3.527 \times 10$	2.205	$1 \times 10^{-3}$	$9.842 \times 10^{-4}$	$1.102 \times 10^{-3}$
$6.480 \times 10^{-5}$	1	$2.286 \times 10^{-3}$	$1.429 \times 10^{-4}$	$6.480 \times 10^{-8}$	$6.378 \times 10^{-8}$	$7.143 \times 10^{-8}$
$2.835 \times 10^{-2}$	$4.375 \times 10^2$	1	$6.25 \times 10^{-2}$	$2.835 \times 10^{-5}$	$2.790 \times 10^{-5}$	$3.125 \times 10^{-5}$
$4.536 \times 10^{-1}$	$7.000 \times 10^3$	$1.6 \times 10$	1	$4.536 \times 10^{-4}$	$4.464 \times 10^{-4}$	$5 \times 10^{-4}$
$1.000 \times 10^3$	$1.543 \times 10^7$	$3.5274 \times 10^4$	$2.205 \times 10^3$	1	$9.842 \times 10^{-1}$	1.102
$1.016 \times 10^3$	$1.568 \times 10^7$	$3.5840 \times 10^4$	$2.240 \times 10^3$	1.016	1	1.12
$9.072 \times 10^2$	$1.4 \times 10^7$	$3.2000 \times 10^4$	$2.000 \times 10^3$	$9.072 \times 10^{-1}$	$8.929 \times 10^{-1}$	1

## Force

N	kgf	lbf	pdl
1	$1.020 \times 10^{-1}$	$2.248 \times 10^{-1}$	7.233
9.807	1	2.205	$7.093 \times 10$
4.448	$4.536 \times 10^{-1}$	1	$3.217 \times 10$
$1.383 \times 10^{-1}$	$1.410 \times 10^{-2}$	$3.108 \times 10^{-2}$	1

## Pressure

MPa	kgf/cm <sup>2</sup>	lbf/in <sup>2</sup> (PSI)	atm	mmHg	inHg	mmH <sub>2</sub> O	ftH <sub>2</sub> O
1	$1.020 \times 10$	$1.450 \times 10^2$	9.869	$7.501 \times 10^3$	$2.953 \times 10^2$	$1.01972 \times 10^5$	$3.346 \times 10^2$
$9.807 \times 10^{-2}$	1	$1.422 \times 10$	$9.678 \times 10^{-1}$	$7.356 \times 10^2$	$2.896 \times 10$	$1.0000 \times 10^4$	$3.281 \times 10$
$6.895 \times 10^{-3}$	$7.031 \times 10^{-2}$	1	$6.805 \times 10^{-2}$	$5.171 \times 10$	2.036	$7.031 \times 10^2$	2.307
$1.013 \times 10^{-1}$	1.033	$1.470 \times 10$	1	$7.60 \times 10^2$	$2.992 \times 10$	$1.0332 \times 10^4$	$3.390 \times 10$
$1.333 \times 10^{-4}$	$1.360 \times 10^{-3}$	$1.934 \times 10^{-2}$	$1.316 \times 10^{-3}$	1	$3.937 \times 10^{-2}$	$1.360 \times 10$	$4.460 \times 10^{-2}$
$3.386 \times 10^{-3}$	$3.453 \times 10^{-2}$	$4.912 \times 10^{-1}$	$3.342 \times 10^{-2}$	$2.54 \times 10$	1	$3.453 \times 10^2$	1.133
$9.806 \times 10^{-6}$	$1 \times 10^{-4}$	$1.422 \times 10^{-3}$	$9.678 \times 10^{-5}$	$7.355 \times 10^{-2}$	$2.896 \times 10^{-3}$	1	$3.281 \times 10^{-3}$
$2.989 \times 10^{-3}$	$3.048 \times 10^{-2}$	$4.335 \times 10^{-1}$	$2.950 \times 10^{-2}$	$2.242 \times 10$	$8.827 \times 10^{-1}$	$3.048 \times 10^2$	1



# CUPLA Inquiry Form

If you are unable to find a CUPLA product that you are looking for, or the type that suits your particular requirements in this catalog, please fill in this form and fax it to our distributor in your country or directly to us. We will select suitable CUPLA for your applications and contact you directly or through our distributor.

## FAX Sheet

To NITTO KOHKI CO., LTD.

Company Name		Factory / Branch	
Department / Section		Full Name	
Address		TEL	
E-mail		FAX	

## CUPLA Usage Conditions

Application	(Product / Machinery) Name ( )	Quantity to Be Used	( ) pieces
Size	( ) Standard or Code to be conformed with, if any ( )	Location	Indoors • Outdoors
Product Name	HI CUPLA • SUPER CUPLA • MOLD CUPLA • SP CUPLA Type A • HSP • 350 • TSP • MINI CUPLA • Others ( )		
Body Material	( )	Seal Material	( )
Surface Treatment	( )	Connection Disconnection Frequency	( ) times / day • ( ) times / month
Valve	Socket ( with • without ) Plug ( with • without )		
Fluid	Air • Water • Oil • Steam (Others: )		
Pressure	Maximum ( ) MPa Normal ( ) MPa Minimum ( ) MPa Impulse ( with • without )		
Maximum Flow	( ) L/min		
Vacuum	( ) kPa		
Temperature	Maximum ( ) °C Normal ( ) °C Minimum ( ) °C		
Type of Thread	1. Unified Thread 2. Male Thread 3. Female Thread 4. Special thread / hose barb Standard or Code to be conformed with, if any ( ) <div style="border: 1px solid black; width: 300px; height: 150px; margin-left: 100px;"></div>		
Other Requirements			

Please do not write in the following section.

Processing	Model		Seal Material		Drawing No.				
	Body Material		Surface Treatment						

Please make your blank copy of this form to fill in.



# Taper Pipe Threads

JIS B 0203:1999  
ISO 7-1:1994  
(BS21)

UDC 621.882.082.2 JIS  
Japanese Industrial Standard

This Japanese Industrial Standard specifies taper pipe threads and is applicable to the threads used mainly for pressure-tight joints on the threads for joining pipes, pipe fittings, fluid machinery, etc.

## Attached Table: Basic Profiles, Basic Dimensions and Tolerance

**Basic Profile Applied for Taper External and Taper Internal Threads**

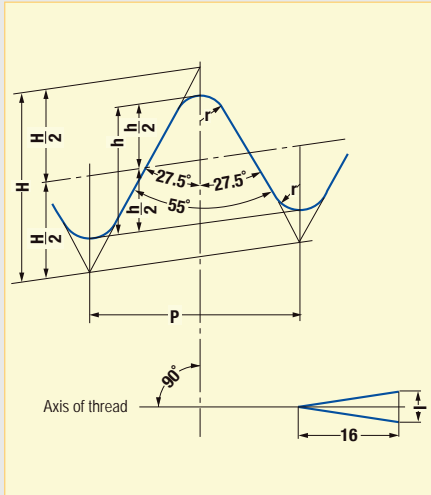

Thick continuous line shows basic profile.

$$P = \frac{25.4}{n}$$

$$H = 0.960237 P$$

$$h = 0.640327 P$$

$$r = 0.137278 P$$

**Basic Profile Applied for Parallel Internal Threads**

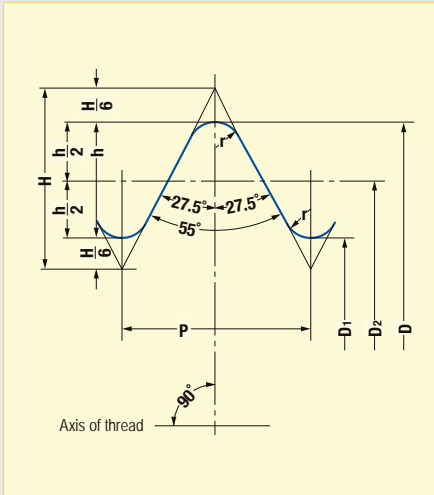

Thick continuous line shows basic profile.

$$P = \frac{25.4}{n}$$

$$H = 0.960491 P$$

$$h = 0.640327 P$$

$$r = 0.137329 P$$

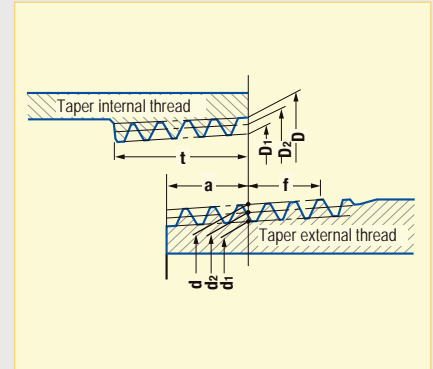

How to symbolize taper pipe threads:

Taper external thread	<b>R 3/8</b>
Taper internal thread	<b>Rc 3/8</b>

Unit: mm

Designation of thread	Thread				Gauge dia.			Position of gauge plane			Tolerance on $D$ , $D_2$ and $D_1$ of parallel internal thread $\pm$	Length of useful thread (min.)				Size of carbon steel pipe for ordinary piping (Given for reference)	
	Number of threads (in 25.4 mm) $n$	Pitch $P$ (Given for reference)	Height of thread $h$	Radius $r$ or $r'$	External thread			External thread	Internal thread			External thread	Internal thread	When there is incomplete thread part	When there is no incomplete thread part	Outer dia.	Thickness
					Major dia. $d$	Pitch dia. $d_2$	Minor dia. $d_1$	From pipe end	At pipe end								
					Internal thread			Gauge length $a$	Axial tolerance $\pm b$	Axial tolerance $\pm c$							
Major dia. $D$	Pitch dia. $D_2$	Minor dia. $D_1$															
R 1/8	28	0.9071	0.581	0.12	9.728	9.147	8.566	3.97	0.91	1.13	0.071	2.5	6.2	7.4	4.4	10.5	2.0
R 1/4	19	1.3368	0.856	0.18	13.157	12.301	11.445	6.01	1.34	1.67	0.104	3.7	9.4	11.0	6.7	13.8	2.3
R 3/8	19	1.3368	0.856	0.18	16.662	15.806	14.950	6.35	1.34	1.67	0.104	3.7	9.7	11.4	7.0	17.3	2.3
R 1/2	14	1.8143	1.162	0.25	20.955	19.793	18.631	8.16	1.81	2.27	0.142	5.0	12.7	15.0	9.1	21.7	2.8
R 3/4	14	1.8143	1.162	0.25	26.441	25.279	24.117	9.53	1.81	2.27	0.142	5.0	14.1	16.3	10.2	27.2	2.8
R 1	11	2.3091	1.479	0.32	33.249	31.770	30.291	10.39	2.31	2.89	0.181	6.4	16.2	19.1	11.6	34.0	3.2
R 1-1/4	11	2.3091	1.479	0.32	41.910	40.431	38.952	12.70	2.31	2.89	0.181	6.4	18.5	21.4	13.4	42.7	3.5
R 1-1/2	11	2.3091	1.479	0.32	47.803	46.324	44.845	12.70	2.31	2.89	0.181	6.4	18.5	21.4	13.4	48.6	3.5
R 2	11	2.3091	1.479	0.32	59.614	58.135	56.656	15.88	2.31	2.89	0.181	7.5	22.8	25.7	16.9	60.5	3.8
R 2-1/2	11	2.3091	1.479	0.32	75.184	73.705	72.226	17.46	3.46	3.46	0.216	9.2	26.7	30.1	18.6	76.3	4.2
R 3	11	2.3091	1.479	0.32	87.884	86.405	84.926	20.64	3.46	3.46	0.216	9.2	29.8	33.3	21.1	89.1	4.2
R 4	11	2.3091	1.479	0.32	113.030	111.551	110.072	25.40	3.46	3.46	0.216	10.4	35.8	39.3	25.9	114.3	4.5
R 5	11	2.3091	1.479	0.32	138.430	136.951	135.472	28.58	3.46	3.46	0.216	11.5	40.1	43.5	29.3	139.8	4.5
R 6	11	2.3091	1.479	0.32	163.830	162.351	160.872	28.58	3.46	3.46	0.216	11.5	40.1	43.5	29.3	165.2	5.0

# Production Facilities That Assure Our Product Quality

Large scale production facilities in Tochigi Prefecture, Japan and Ayutthaya, Thailand, having the capability of flexible mass production, are in full operation around the clock and constitute a complete high-grade supply system, from the machining of components to the assembly and testing of finished products, that is forever ready and able to respond to our user's reliance.

## Production Facilities Assure Flexible Supply System

### TOCHIGI NITTO KOHKI CO., LTD.

Production of CUPLA, Linear-Motor-Driven Piston Pumps and their Applied Products

Tochigi Nitto Kohki factory is accredited under ISO 14001 & 9001.



In November 1995, the Japan Quality Assurance Foundation, authority for inspection and registration, awarded Tochigi Nitto Kohki "ISO 9001" for quality control and quality assurance in the manufacture of CUPLA products (Quick connect couplings) as well as 1 kW or smaller Linear Drive air compressors, vacuum pumps and applied products, and in November 2001 "ISO 14001", also awarded International Standard for environment management systems intended to perform global environment preservation and pollution control.



### NITTO KOHKI INDUSTRY (THAILAND) CO., LTD.

Production of CUPLA, Air Compressors, and Vacuum Pumps

ISO 14001 & 9001



NITTO KOHKI INDUSTRY (THAILAND) CO., LTD. factory is accredited under ISO 14000 and ISO 9001.





# From Development to Production, Management and Marketing of “CUPLA”

Nitto Kohki has introduced the “integrated product assurance system” that can respond promptly to “users’ requirements” by covering the range of development, quality control, production and marketing in order to ensure supply of high-performance high-quality “CUPLA”.

## Nitto Kohki’s Integrated Product Assurance System

### Research and Development

The needs of the time and the latest information are gathered and analyzed, and unique technology is utilized to the challenge for ceaseless development of better CUPLA, CUPLA that suggest new applications.



Headquarters and R & D Laboratory



### Quality Control

The careful selection of materials, painstaking pursuit of machining precision, and strict surveillance processes such as severe endurance tests have earned trust for CUPLA as a global brand.

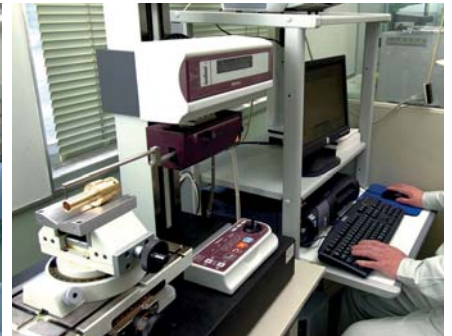

### Production

High-grade, rationalized, and integrated production system extends from the machining of parts to the assembly and testing of completed products. Robots that we make ourselves for our own plants and many other state-of-the-art facilities that cannot be seen elsewhere have marvelous capacity for mass production. And with them all, we aim to be an establishment of a flexible supply system.

Tochigi Nitto Kohki factory is accredited under ISO 14001 & 9001.



### Marketing

Meticulous marketing activities include advertising in the general industrial press and specialist papers, national and local exhibitions, training sessions, catalogs, promotion videos, other presentation tools and technical data sheets for new launches, and unique yet dynamic campaigns, etc.





# Nitto Kohki's Laborsaving Products

Nitto Kohki is capturing the needs of users by introducing to the world not only "CUPLA" quick connect couplings, but also next-generation laborsaving devices, including various "Power and Machine Tools", high precision "delvo" electric screwdrivers, and linear-motor-driven free piston "compressors / vacuum pumps".

## Nitto Kohki's Quality Products



### Machines and Tools to Achieve Energy and Labor Savings in Processing Work

Machines and tools are used at various processing sites for such work as cutting, polishing, scaling, drilling and chamfering of steel materials. We have created a product line up of pneumatic, electric and hydraulic machines and tools to match the diversification of processing methods and the conditions of work operations.



### Compressors, Vacuum Pumps and Their Applied Products

NITTO KOHKI pumps are unique products featuring a linear-motor-driven free piston system. NITTO KOHKI has made available a complete series of air compressors and suction pumps that incorporate this uniquely functional design. These are quite appropriate as air sources or suction power units for various pneumatically operated equipment and apparatus in advanced industries.



### High Precision "delvo" Electric Screwdrivers for Professional Use

NITTO KOHKI Electric Screwdriver "delvo" is high-quality tools for professional use, with special emphasis on precise control of torque and long life. They apply just the correct amount of torque –with sure, positive control always at your fingertips. They are smooth and shockless in operation, too.



### Door Closer "AUTO-HINGE" Series Center Hang Type / Flag Type / Sliding Door Closer

Door closer is a product which allows doors to be closed quietly and safely. Used for various doors worldwide such as medical institutions, wellness centers, offices and transportation equipment. The door closing is automatically controlled by the action of springs and hydraulics, resulting in an armless and neat door.

## Safety Precautions

The safety precautions provide instructions for the safe use of NITTO KOHKI coupling "CUPLA" to avoid the potential danger of bodily harm or damage to surrounding property. The safety precautions are categorized under the headings **Danger, Warning and Caution**, in accordance with the degree of potential hazard to the body or surrounding property, if CUPLA is used incorrectly. They are all important notes for safety and must be followed as well as in accordance with International standards #1 and other local safety regulations #2.

#1: ISO 4413, Hydraulic Fluid Power – General rules relating to systems    ISO 4414, Pneumatic Fluid Power – General rules relating to systems  
#2: Industrial Health & Safety law (for example)



### **DANGER**

Indicates an imminently hazardous situation which, if not avoided, will result in death or serious injury.

### **DANGER**

Stop using the product immediately if there is any anticipated danger of operation or reduced safety.



### **WARNING**

Indicates a potentially hazardous situation which, if not avoided, could result in death or serious injury.

### **WARNING**

The enclosed safety precautions are only a guideline. When using CUPLA, you are requested to pay particular attention to possible hazardous situations for the application which are not stated in the safety precautions.



### **CAUTION**

Indicates a potentially hazardous situation which, if not avoided, may result in personal injury or property damage.

## Caution When Selecting CUPLA

### **DANGER**

- Connection to a coupling of another brand may cause imperfect connection or disconnection, reduced air tightness, impaired pressure resistance or durability, reduced flow rate and potentially result in an unexpected accident and therefore must be avoided. Nitto Kohki cannot accept liability for any accident that may result by mixed use with the coupling of another brand. Please be sure to check for our marks on the right hand side of this page, which are always inscribed on NITTO KOHKI coupling "CUPLA" when you order and purchase.
- Do not use CUPLA under conditions and environments other than specified in the catalog.

### **WARNING**

- Please consult us prior to use if CUPLA is required for use on machines, equipment or systems (hereafter referred to as "equipment, systems, etc.") for sustaining or controlling human life or body.
- When CUPLA is used for the purpose of ensuring safety, please consult us beforehand.
- The compatibility of the product with specific equipment, systems, etc. must be determined by the person designing the equipment, systems, etc. or the person who decides its specifications based on necessary analysis and test result. The expected performance and safety assurance of the equipment, systems, etc. will be the responsibility of the person who has determined its compatibility with the product.
- If CUPLA is to be used for the following applications, please consult us:
  - Vehicles, aircraft and associated equipment systems that accommodate people
  - Medical facilities or suction equipment that directly affects human body
  - Equipment that directly comes into contact with and runs food, drugs or medicines, drinking water, atomic energy equipment or equipment that ensures safety.
- Selecting the wrong type of seal material may cause a leak. In making your selection, please check the compatibility of the seal material with the type of fluid and temperature used in the application.
- Please consult us prior to selection or use of CUPLA when they are intended for use with corrosive or flammable gases/liquids and/or in atmospheres of these types of gases and liquids.

## Warranty and Disclaimer

**Our responsibilities for the defects in our products shall be as follows:**

- We shall be responsible for any defects in design, material or workmanship of our products, if it is apparent that such defects are due to reasons solely attributable to us.
- Our responsibilities shall be limited to one of the following, as determined by us:
  - (a) repair of any defective products or parts thereof,
  - (b) replacement of any defective products or parts thereof; or
  - (c) compensation for loss and damages incurred by you, which shall in no case exceed the amount of your purchase price for the defective products.
- We shall in no case be liable for any special, indirect or consequential loss or damages, whether such loss or damages are those arising from work stoppage, impairment of other goods or death or personal injury.

## Performance, Dimensions and Its Limitation

Please note the performance charts and outside dimensions in this catalog do not take into account any tolerances found in mass production. The information is an average or standard value to be a guide for selecting models and to enable technical appraisal by users.

## Beware of Imitations

Recently, similar products which invite misidentification or confusion with NITTO KOHKI coupling "CUPLA" have appeared on the market. Connection with such a similar product to NITTO KOHKI coupling "CUPLA" may cause:

1. Imperfect connection or disconnection
2. Reduced air tightness
3. Impaired pressure resistance or durability
4. Reduced flow rate

and could result in unexpected accidents.

Therefore, connection other than with NITTO KOHKI coupling "CUPLA" must be avoided.

Please be sure to check for our original marks on the right hand side of this page, which are always inscribed on NITTO KOHKI coupling "CUPLA" products, when you order and purchase.

### Note:

**Nitto Kohki cannot accept any liability for any accident that may occur as a result of using couplings of another brand in conjunction with our own.**

## Markings



# Safety Guide

The following precautions must be taken when using CUPLA. Please contact Nitto Kohki or the outlet / supplier where you purchased the product with regard to repair procedures, certification on the specification or applications of the products.



## Precautions Relating to the Use of All CUPLA products

Be sure to read the "Instruction Sheet" that comes with the product or "Caution" on the package before use.

### CUPLA for Low Pressure (Air)

#### ⚠ Caution

- Prior to use, check the compatibility of the seal material and body material against the temperature and the fluid to be used. Selecting the wrong seal material will lead to leakage.
- As to the use of any special paint or solvent, make thoroughly sure of the material compatibility.
- Do not use CUPLA continuously exceeding the rated working pressure. It will cause leakage or damage.
- Only use CUPLA that are within their rated temperature range. Otherwise this can lead to leakage through seal deterioration or damage. It cannot be used continuously at its lowest or highest rated working temperature.
- The durability of CUPLA differs depending on the operating environment and conditions (pressure and temperature etc.). If necessary, conduct performance evaluation test under your actual operating environment and conditions. Also, stress corrosion cracking may occur if used under corrosive environment. Take note of usage conditions.
- The working pressure and working temperature range for hose barb types and braided hose connection types differs depending on the hose to be used.
- Prior to use, confirm that the temperature and the type of fluid to be used is suitable for the hose.
- When cleaning CUPLA, care must be taken not to use any material that will affect the seal and body materials.
- Apply a fluoropolymer resin sealant tape on male tapered pipe threads to ensure no leak. (Applies to thread type)
- Do not exceed the recommended maximum torque when screwing in to the male or female thread of CUPLA for installation. It will cause damage. (Applies to thread type, Nut type)
- Care must be taken when installing CUPLA not to overtighten or cross thread, this can cause damage and lead to leakage. (Applies to thread type, Nut type, especially body material: stainless steel)
- Do not use anything other than the applicable hose or tube sizes. It will cause leakage. (Applies to hose or tube fitter connection type)
- Insert the barb (tail) fully into a hose or a tube and secure it tightly with a hose clamp or a nut. Incomplete insertion or insufficient clamping will lead to leakage or sliding off of a hose or a tube from the barb (tail). (Applies to hose or tube fitter connection type)
- Never strike CUPLA when inserting barb (tail) into hose or tube. This could cause poor connection. (Applies to hose or tube fitter connection type)
- Do not use damaged (cracked) or deteriorated hoses or tubes. It will lead to leakage or bursting of hoses or tubes. (Applies to hose or tube fitter connection type)
- Cut off the hose or tube at a designated length from the end when reusing it. Failure to do so will lead to leakage or bursting of the hose or tube. See the "Instruction manual" enclosed with the product for the normal length. (Applies to hose or tube fitter connection type)
- Prior to use, always perform a leak test after installing CUPLA.
- After connection, try to pull the socket and plug apart to confirm secure connection. If the connection is incomplete, the socket and plug may disconnect when pressurized.
- Care should be taken when disconnecting CUPLA whilst still pressurized. To prevent injury due to the Plug popping out, the Socket should be held firmly in one hand and the Plug in the other.
- If the medium is gas, an audible bang may be heard on disconnection. We recommend disconnecting this CUPLA in an unpressurized state. (Except for CUPLA with purge function)
- Put a designated dust cap on CUPLA after disconnection when there is a possibility of foreign matter such as dirt sticking to the seal surface.
- Always install a shut-off valve between the pressure source and CUPLA.
- Do not use with any fluid or medium other than what is specified, to do so could cause leakage or damage.
- The use of inline filters is strongly advised and recommended. To prevent damage, the fluid should be clean before reaching CUPLA.
- Always let fluid flow from socket to plug. It will result in reduced flow. (Except for HI CUPLA Two Way Type)
- Do not use CUPLA in areas or environment where dust such as sand or metal powder can get in to CUPLA. It will lead to malfunction or leakage.
- Do not let paint stick to CUPLA. It will cause malfunction or leakage.
- Be careful not to put scratches or dents on CUPLA. Especially, scratches on the sealing parts will cause leakage.
- Do not apply any artificial impact, bend or tension. It will cause leakage or damage.
- Do not drop CUPLA. It will cause leakage or malfunction.
- Connecting CUPLA directly to vibrating or impacting equipment will result in reduced lifetime. The use of a "Leader" or "Whip" hose of approx. 30 cm in length between CUPLA and equipment is recommended to help alleviate this.
- Use only as quick connect couplings for fluid pipelines. (It cannot be used as a swivel joint)
- Only use CUPLA in a combination with NITTO KOHKI coupling "CUPLA".
- Do not disassemble CUPLA. It will cause leakage or damage.

### Cautions on Handling CUPLA HOSE

#### ⚠ Caution

- Do not use CUPLA continuously exceeding the rated working pressure. It will cause leakage or damage.
- Only use CUPLA that are within their rated temperature range. Otherwise the hose will get damaged or deteriorate and cause leakage. It cannot be used continuously at its lowest or highest rated working temperature.
- Do not use on systems that have a high water content, such as drain discharge, this can damage the hose.
- The durability of the Hose differs depending on the operating environment and conditions (pressure and temperature etc.). If necessary, conduct performance evaluation test under your actual operating environment and conditions.
- Make sure that there is no twist or bend on the hose before use.
- Do not exceed the maximum extensible length, to do so will damage the hose. See catalogue page for full specification details. (Applies to NK CUPLA COIL HOSE)
- Do not bend the hose less than the minimum-bending radius. It will cause damage to the hose. (ø6.5xø10 mm minimum-bending radius :40 mm, ø8.5xø12.5 mm minimum-bending radius : 50 mm : Applies to NK CUPLA HOSE)
- Do not use with any fluid or medium other than what is specified, to do so could damage the hose.
- The use of inline filters is strongly advised and recommended. To prevent damage, the fluid should be clean before reaching CUPLA. The inclusion of foreign matter in the fluid could damage the hose.
- Do not use CUPLA in areas or environment where dust such as sand or metal powder can get in to CUPLA. This may cause damage to the hose.
- Do not use near fire. It will soften or deform the hose and cause damage to the hose.
- Take care not to damage the hose by dragging over rough ground or concrete. It is also important to ensure that the hose does not become kinked or crushed for long periods.
- Do not use for lifting or hoisting, this can damage the hose.
- Store in a shaded, dry and well-ventilated place.
- Cut off the hose at least 3 cm from the end when reusing it. Failure to do so will lead to leakage or bursting of the hose.
- Prior to use, always perform a leak test after installing CUPLA.

### CUPLA for Oxygen / Fuel Gas

#### ⚠ Warning

- Do not use with any fluid or medium other than what is specified, to do so could cause leakage or damage.
- Do not use CUPLA continuously exceeding the rated working pressure. It will cause leakage or damage.
- Replace CUPLA with a new one if backfire occurs. Backfire damages the body and the seal and will lead to leakage or damage.
- Do not use damaged (cracked) or deteriorated hoses. It will lead to leakage or bursting of hoses. (Applies to hose barb type)
- Never let oil adhere to CUPLA when installing a hose. It will cause spontaneous fire.
- Insert the barb (tail) fully into a hose and secure it tightly with a hose clamp or a nut. Incomplete insertion or insufficient clamping will lead to leakage or sliding off of a hose from the barb (tail). (Applies to hose barb type)
- Prior to use, always perform a leak test after installing CUPLA before use. If any leakage is found, stop using immediately.
- Cut off the hose at least 3 cm from the end when reusing it. Failure to do so will lead to leakage or bursting of the hose. (Applies to hose barb type)
- Do not use CUPLA near fire or places where gas accumulates. It will lead to fire or explosion.
- Make sure that the valve on the torch is closed before connecting to CUPLA. If connected with valve open, the gas will flow out and could cause a fire or explosion.
- Do not disassemble CUPLA. It will cause leakage or damage.

#### ⚠ Caution

- Only use CUPLA that are within their rated temperature range. Otherwise this can lead to leakage through seal deterioration or damage. It cannot be used continuously at its lowest or highest rated working temperature.
- The durability of CUPLA differs depending on the operating environment and conditions (pressure and temperature etc.). If necessary, conduct performance evaluation test under your actual operating environment and conditions. Also, stress corrosion cracking may occur if used under corrosive environment. Take note of usage conditions.
- Make sure that O-rings and Packing seals are lubricated with our designated lubricant at all times. The O-rings will get damaged and cause leakage. Not using the designated lubricant will lead to spontaneous fire. (Ask us for the designated lubricant)
- Apply a fluoropolymer resin sealant tape on male tapered pipe threads to ensure no leak. (Applies to thread type)
- Do not exceed the recommended maximum torque when screwing in to the male or female thread of CUPLA for installation. It will cause damage. (Except for hose barb type)
- Do not use anything other than the applicable hose sizes. It will cause leakage. (Applies to hose barb type)
- Never strike CUPLA when inserting barb (tail) into hose. This could cause poor connection. (Applies to hose barb type)
- Do not use damaged (cracked) or deteriorated hoses. It will lead to leakage or bursting of hoses. (Applies to hose barb type)
- After connection, try to pull the socket and plug apart to confirm secure connection. If the connection is incomplete, the socket and plug may disconnect when pressurized.
- Care should be taken when disconnecting CUPLA whilst still pressurized. To prevent injury due to the Plug popping out, the Socket should be held firmly in one hand and the Plug in the other.
- If the medium is gas, an audible bang may be heard on disconnection. We recommend disconnecting this CUPLA in an unpressurized state.
- Always install a shut-off valve between the pressure source and the socket.
- The use of inline filters is strongly advised and recommended. To prevent damage, the fluid should be clean before reaching CUPLA.
- Always let fluid flow from socket to plug. It will result in reduced flow.
- Do not use CUPLA in areas or environment where dust such as sand or metal powder can get in to CUPLA. It will lead to malfunction or leakage.
- Do not let paint stick to CUPLA. It will cause malfunction or leakage.
- Be careful not to put scratches or dents on CUPLA. Especially, scratches on the sealing parts will cause leakage.
- Do not apply any artificial impact, bend or tension. It will cause leakage or damage.
- Do not drop CUPLA. It will cause leakage or malfunction.
- Connecting CUPLA directly to vibrating or impacting equipment will result in reduced lifetime.
- Use only as quick connect couplings for fluid pipelines. (It cannot be used as a swivel joint)
- Only use CUPLA in a combination with NITTO KOHKI coupling "CUPLA".
- Store CUPLA in a dry environment. Moisture will cause corrosion and may also freeze in low temperatures, which may cause malfunction of CUPLA or other equipment.





## Precautions Relating to the Use of All CUPLA products

Be sure to read the "Instruction Sheet" that comes with the product or "Caution" on the package before use.

### MOLD CUPLA / FLOW MONITOR / FLOW METER / HOT WATER CUPLA

#### ⚠ Warning

- Do not apply pressure to CUPLA socket while it is disconnected. It will cause leakage or damage. (Applies to MOLD CUPLA or HOT WATER CUPLA)
- Do not use CUPLA continuously exceeding the rated working pressure. It will cause leakage or damage.
- The fluid in the piping of the plug side will spill out upon disconnection. When using for hazardous fluids (such as hot fluid), discharge all the fluid inside CUPLA before disconnecting, in order to prevent burns, etc. (Applies to MOLD CUPLA)

#### ⚠ Caution

- Prior to use, check the compatibility of the seal material and body material against the temperature and the fluid to be used. Selecting the wrong seal material will lead to leakage.
  - As to the use of any special paint or solvent, make thoroughly sure of the material compatibility.
- Only use CUPLA that are within their rated temperature range. Otherwise this can lead to leakage through seal deterioration or damage. It cannot be used continuously at its lowest or highest rated working temperature.
- Even if used within the rated operating temperature range, prolonged use of the FLOW METER when under pressure and with the temperature in the upper regions will cause leakage. (Especially when the valve is fully open)
- The durability of CUPLA or FLOW METER differs depending on the operating environment and conditions (pressure and temperature etc.). If necessary, conduct performance evaluation test under your actual operating environment and conditions.
  - Also, stress corrosion cracking may occur if used under corrosive environment. Take note of usage conditions.
- The working pressure and working temperature range for hose barb types and braided hose connection types differs depending on the hose to be used.
  - Prior to use, confirm that the temperature and the type of fluid to be used is suitable for the hose. (Applies to MOLD CUPLA)
- Make sure that O-rings and Packing seals are lubricated with grease at all times. If not, the O-rings will get damaged and cause leakage.
- Apply a fluoropolymer resin sealant tape on male tapered pipe threads to ensure no leak. (Applies to MOLD CUPLA thread type or FLOW MONITOR or FLOW METER or HOT WATER CUPLA)
- Do not exceed the recommended maximum torque when screwing in to the male or female thread of CUPLA for installation. It will cause damage.
  - When installing FLOW METER, in order to protect the spherical surface of the ball valve, install it with the valve in a fully opened state as a rule. (Applies to MOLD CUPLA thread type or FLOW MONITOR or FLOW METER or HOT WATER CUPLA)
  - When the valve is fully open or closed, there will be a void between valve body and the ball valve which can trap a small amount of fluid under pressure.
- Before taking the body off from the piping, partially open the valve to allow the pressure to discharge. (Applies to FLOW METER)
- Do not use anything other than the applicable hose sizes. It will cause leakage. (Applies to hose barb type)
- Insert the barb (tail) fully into a hose and secure it tightly with a hose clamp. Incomplete insertion or insufficient clamping will lead to leakage or sliding off of a hose from the barb (tail). (Applies to hose barb type)
- Never strike CUPLA when inserting barb (tail) into hose. This could cause poor connection. (Applies to hose barb type)
- Do not use damaged (cracked) or deteriorated hoses. It will lead to leakage or bursting of hoses. (Applies to hose barb type)
- Cut off the hose at least 3 cm from the end when reusing it. Failure to do so will lead to leakage or bursting of the hose. (Applies to hose barb type)
- Prior to use, always perform a leak test after installing CUPLA.
- After connection, try to pull the socket and plug apart to confirm secure connection. If the connection is incomplete, the socket and plug may disconnect when pressurized. (Applies to MOLD CUPLA or HOT WATER CUPLA)
- Do not connect/disconnect with fluid still under dynamic pressure or static residual pressure. It will cause damage to the valve. (Applies to MOLD CUPLA or HOT WATER CUPLA)
- Always install a shut-off valve between the pressure source and CUPLA.
- Do not use with any fluid or medium other than what is specified, to do so could cause leakage or damage.
- Use it in the state that the fluid does not freeze in the case of water. If it freezes, it will cause damage to CUPLA.
- The use of inline filters is strongly advised and recommended. To prevent damage, the fluid should be clean before reaching CUPLA.
- Design and keep the fluid flow speed through CUPLA below 8 m/s. It will cause damage to the packing if used at 8 m/s or over.
- When using FLOW METER, operate the ball valve slowly to prevent water hammer from occurring.
- Let fluid flow in the direction of the arrow shown on the FLOW METER. (Applies to FLOW METER)
- The FLOW METER may cause malfunction of the float due to contamination of foreign matter, water scale or air bubbles inside the fluid.
- Do not use CUPLA in areas or environment where dust such as sand or metal powder can get in to CUPLA. It will lead to malfunction or leakage.
- Do not let paint stick to CUPLA. It will cause malfunction or leakage.
- Be careful not to put scratches or dents on CUPLA. Especially, scratches on the sealing parts will cause leakage. (Applies to MOLD CUPLA or HOT WATER CUPLA)
- Do not apply any artificial impact, bend or tension. It will cause leakage or damage.
- Do not drop CUPLA. It will cause leakage or malfunction.
- Connecting CUPLA directly to vibrating or impacting equipment will result in reduced lifetime.
- Use only as quick connect couplings/flow meter for fluid pipelines. (It cannot be used as a swivel joint)
- Only use CUPLA in a combination with NITTO KOHKI coupling "CUPLA". (Applies to MOLD CUPLA or HOT WATER CUPLA)
- Do not disassemble CUPLA. It will cause leakage or damage.
- When storing FLOW METER, ensure that the valve is fully open. If stored with the valve partially open, the packing will deform and cause leakage.
- Do not replace the Flow Vane ASSY when FLOW MONITOR is in high temperature state, pressurized state or when pressure is remaining.
- Do not replace the Flow Vane ASSY with the stop valve open. Be sure to install a stop valve on the source pressure side of FLOW MONITOR. The impeller may stop even if fluid is flowing due to foreign matter. (Applies to FLOW MONITOR)
- FLOW MONITOR is designed mainly for water. If water containing oil or rust preventive agent is used, the durability of plastic parts may be reduced.
  - After checking with the actual machine under your operating environment conditions, please determine whether FLOW MONITOR can be used.
- Prior to use, always perform a leak test after installing FLOW MONITOR and replacing the Flow Vane ASSY. (Applies to FLOW MONITOR)
- Attach the Stopper to the notch on the main unit. (Applies to FLOW MONITOR)
- Be sure to purify the working fluid through a mesh filter smaller than 40 mesh. (Applies to FLOW MONITOR)
- Use FLOW MONITOR in the flow rate range of 2 L/min to 20 L/min. (Applies to FLOW MONITOR)
- When flowing air into FLOW MONITOR (Air purge of mold temperature controller, etc.), do not flow continuously for a long time. It may cause malfunction of the impeller and damage to plastic parts. (Applies to FLOW MONITOR)
- Do not use it for any purpose other than visual inspection of fluid flow. (Applies to FLOW MONITOR)
- FLOW MONITOR has a swivel structure, but do not rotate it except for installation and removal.
- When cleaning FLOW MONITOR, use a method that will not affect the seal material, plastic and body material.

### CUPLA for Low Pressure (Water, Liquid) and for Medium Pressure

#### ⚠ Warning

- Do not apply pressure to CUPLA socket or plug while they are disconnected. It will cause leakage or damage. (Applies to Valve Structures: Two-way shut-off type and One-way shut-off type)
- Do not use CUPLA continuously exceeding the rated working pressure. It will cause leakage or damage.
- The fluid in the piping will spill out upon disconnection. When using for hazardous fluids (such as hot fluid), discharge all the fluid inside CUPLA before disconnecting, in order to prevent burns, etc. (Applies to Valve Structures: Straight through type and One-way shut-off type)

#### ⚠ Caution

- Prior to use, check the compatibility of the seal material and body material against the temperature and the fluid to be used. Selecting the wrong seal material will lead to leakage.
  - As to the use of any special paint or solvent, make thoroughly sure of the material compatibility.
- Only use CUPLA that are within their rated temperature range. Otherwise this can lead to leakage through seal deterioration or damage. It cannot be used continuously at its lowest or highest rated working temperature.
- Even if used within the rated operating temperature range, prolonged use of TSP CUPLA Socket with Ball Valve when under pressure and with the temperature in the upper regions will cause leakage. (Especially when the valve is fully open)
- The durability of CUPLA differs depending on the operating environment and conditions (pressure and temperature etc.). If necessary, conduct performance evaluation test under your actual operating environment and conditions.
  - Also, stress corrosion cracking may occur if used under corrosive environment. Take note of usage conditions.
- The working pressure and working temperature range for hose barb types and braided hose connection types differs depending on the hose to be used.
  - Prior to use, confirm that the temperature and the type of fluid to be used is suitable for the hose or tube.
- When cleaning CUPLA, care must be taken not to use any material that will affect the seal and body materials.
- Make sure that O-rings and Packing seals are lubricated with grease at all times. If not, the O-rings will get damaged and cause leakage. (Except CUPLA with end face seal construction)
- Apply a fluoropolymer resin sealant tape on male tapered pipe threads to ensure no leak. (Applies to thread type)
- Do not exceed the recommended maximum torque when screwing in to the male or female thread of CUPLA for installation. It will cause damage.
  - When installing TSP CUPLA Socket with Ball Valve, in order to protect the spherical surface of the ball valve, install it with the valve in a fully opened state as a rule. (Applies to thread type, Nut type)
  - Care must be taken when installing CUPLA not to overtighten or cross thread, this can cause damage and lead to leakage. (Applies to thread type, Nut type, especially body material: stainless steel)
  - When the valve is fully open or closed, there will be a void between valve body and the ball valve which can trap a small amount of fluid under pressure.
- Before taking the body off from the piping, partially open the valve to allow the pressure to discharge. (Applies to TSP CUPLA Socket with Ball Valve)
- Do not use anything other than the applicable hose or tube sizes. It will cause leakage. (Applies to hose or tube fitter connection type)
- Insert the barb (tail) fully into a hose or a tube and secure it tightly with a hose clamp or a nut. Incomplete insertion or insufficient clamping will lead to leakage or sliding off of a hose or a tube from the barb (tail). (Applies to hose or tube fitter connection type)
- Never strike CUPLA when inserting barb (tail) into hose or tube. This could cause poor connection. (Applies to hose or tube fitter connection type)
- Do not use damaged (cracked) or deteriorated hoses or tubes. It will lead to leakage or bursting of hoses or tubes. (Applies to hose or tube fitter connection type)
- Cut off the hose or tube at a designated length from the end when reusing it. Failure to do so will lead to leakage or bursting of the hose or tube. See the "Instruction manual" enclosed with the product for the normal length. (Applies to hose or tube fitter connection type)
- Prior to use, always perform a leak test after installing CUPLA.
- After connection, try to pull the socket and plug apart to confirm secure connection. If the connection is incomplete, the socket and plug may disconnect when pressurized.
- Put a designated dust cap on CUPLA after disconnection when there is a possibility of foreign matter such as dirt sticking to the seal surface.
- Do not connect/disconnect with fluid still under dynamic pressure or static residual pressure. It will cause damage to the valve. (Applies to Valve Structures: Two-way shut-off type and One-way shut-off type)
- Always install a shut-off valve between the pressure source and CUPLA.
- Do not strike the tip of an automatic shut-off valve with a hammer or a similar tool. It will cause leakage or malfunction. (Applies to medium pressure, Valve Structure: Two-way shut-off type) However, if you need to relieve residual pressure, please consult us.
- Do not use with any fluid or medium other than what is specified, to do so could cause leakage or damage.
- Use it in the state that the fluid does not freeze in the case of water. If it freezes, it will cause damage to CUPLA.
- The use of inline filters is strongly advised and recommended. To prevent damage, the fluid should be clean before reaching CUPLA.
- Design and keep the fluid flow speed through CUPLA below 8 m/s. It will cause damage to the valve if used at 8 m/s or over. (Applies to Valve Structures: Two-way shut-off type and One-way shut-off type)
- When using TSP CUPLA Socket with Ball Valve, operate the ball valve slowly to prevent water hammer from occurring. Also be careful not to get fingers caught when operating the handle.

# Safety Guide



## Precautions Relating to the Use of All CUPLA products

Be sure to read the "Instruction Sheet" that comes with the product or "Caution" on the package before use.

### CUPLA for Low Pressure (Water, Liquid) and for Medium Pressure

#### Caution

- Do not use CUPLA in areas or environment where dust such as sand or metal powder can get in to CUPLA. It will lead to malfunction or leakage.
- Do not let paint stick to CUPLA. It will cause malfunction or leakage.
- Be careful not to put scratches or dents on CUPLA. Especially, scratches on the sealing parts will cause leakage.
- Do not apply any artificial impact, bend or tension. It will cause leakage or damage.
- Do not drop CUPLA. It will cause leakage or malfunction.
- Connecting CUPLA directly to vibrating or impacting equipment will result in reduced lifetime.
- Use only as quick connect couplings for fluid pipelines. (It cannot be used as a swivel joint)
- Only use CUPLA in a combination with NITTO KOHKI coupling "CUPLA". (Except LEVER LOCK CUPLA)
- Do not disassemble CUPLA. It will cause leakage or damage.
- When storing TSP CUPLA Sockets with Ball valve, ensure that the valve is fully open. If stored with the valve partially open, the packing will deform and cause leakage.

### CUPLA for High Pressure

#### Danger

- Do not apply pressure to CUPLA socket or plug while they are disconnected. It will cause leakage or damage.

#### Warning

- Do not use CUPLA continuously exceeding the rated working pressure. Also, do not use 700R CUPLA in an environment where there is impulse pressure. It will cause leakage or damage.
- Do not connect/disconnect with fluid still under dynamic pressure or static residual pressure. It will cause damage to the valve. However, the HSP-PV type can be connected under static residual pressure.
- After connection, try to pull the socket and plug apart to confirm secure connection. If the connection is incomplete, the socket and plug may disconnect when pressurized.
- Only use CUPLA in a combination with NITTO KOHKI coupling "CUPLA". However, 280 CUPLA is interchangeable with couplers complying with ISO7241-1A.
  - When using by connecting 280 CUPLA with other brand's, compare the pressure specifications and use under the lower pressure.
- Do not disassemble CUPLA. It will cause leakage or damage.

#### Caution

- Prior to use, check the compatibility of the seal material and body material against the temperature and the fluid to be used. Selecting the wrong seal material will lead to leakage.
  - As to the use of any special paint or solvent, make thoroughly sure of the material compatibility.
- Only use CUPLA that are within their rated temperature range. Otherwise this can lead to leakage through seal deterioration or damage. It cannot be used continuously at its lowest or highest rated working temperature.
- The durability of CUPLA differs depending on the operating environment and conditions (pressure and temperature etc.). If necessary, conduct performance evaluation test under your actual operating environment and conditions. Also, stress corrosion cracking may occur if used under corrosive environment. Take note of usage conditions.
- When cleaning CUPLA, care must be taken not to use any material that will affect the seal and body materials.
- Make sure that O-rings and Packing seals are lubricated with grease or oil at all times. If not, the O-rings will get damaged and cause leakage.
- Apply a fluoropolymer resin sealant tape on male tapered pipe threads to ensure no leak.
- Do not exceed the recommended maximum torque when screwing in to the male or female thread of CUPLA for installation. It will cause damage.
- Care must be taken when installing CUPLA not to overtighten or cross thread, this can cause damage and lead to leakage. (Applies to HSU CUPLA, S210 CUPLA)
- Prior to use, always perform a leak test after installing CUPLA.
- Put a designated dust cap on CUPLA after disconnection when there is a possibility of foreign matter such as dirt sticking to the seal surface.
- Always install a shut-off valve between the pressure source and CUPLA.
- Do not strike the tip of an automatic shut-off valve with a hammer or a similar tool. It will cause leakage or malfunction. However, if you need to relieve residual pressure, please consult us.
- Do not use with any fluid or medium other than what is specified, to do so could cause leakage or damage. Do not use 280 CUPLA with water-glycol operating oil. The plating will dissolve.
- Use it in the state that the fluid does not freeze in the case of water. If it freezes, it will cause damage to CUPLA.
- The use of inline filters is strongly advised and recommended. To prevent damage, the fluid should be clean before reaching CUPLA.
- Design and keep the fluid flow speed through CUPLA below 8 m/s. It will cause damage to the valve if used at 8 m/s or over.
- Do not use CUPLA in areas or environment where dust such as sand or metal powder can get in to CUPLA. It will lead to malfunction or leakage.
- Do not let paint stick to CUPLA. It will cause malfunction or leakage.
- Be careful not to put scratches or dents on CUPLA. Scratches on the sealing parts will cause leakage. Especially, be careful about the seating surface of HSP CUPLA with male parallel thread with 30° flare.
- Do not apply any artificial impact, bend or tension. It will cause leakage or damage.
- Do not drop CUPLA. It will cause leakage or malfunction. If FLATFACE CUPLA FF plug is dropped, there is a possibility that the valve may open, to re-set, connect the Socket to the Plug and disconnect, the valve will return to its original position.
- Connecting CUPLA directly to vibrating or impacting equipment will result in reduced lifetime.
- Use only as quick connect couplings for fluid pipelines. (It cannot be used as a swivel joint)
- When using O-Ring seals for GP Type or GS Type of HSP CUPLA, use the O-Ring size described on the "Instruction manual" enclosed with the product.
- Due to the metal-touch valve structure, 450B CUPLA and 700R CUPLA will slightly leak when not coupled.
- Contact us when using CUPLA for high pressure gases.

### MULTI CUPLA Series

#### Overall MULTI CUPLA

#### Caution

- Prior to use, check the compatibility of the seal material and body material against the temperature and the fluid to be used. Selecting the wrong seal material will lead to leakage.
  - As to the use of any special paint or solvent, make thoroughly sure of the material compatibility.
- Only use CUPLA that are within their rated temperature range. Otherwise this can lead to leakage through seal deterioration or damage. It cannot be used continuously at its lowest or highest rated working temperature.
- The durability of CUPLA differs depending on the operating environment and conditions (pressure and temperature etc.). If necessary, conduct performance evaluation test under your actual operating environment and conditions. Also, stress corrosion cracking may occur if used under corrosive environment. Take note of usage conditions.
- When cleaning CUPLA, care must be taken not to use any material that will affect the seal and body materials.
- Apply a fluoropolymer resin sealant tape on male tapered pipe threads to ensure no leak. (Applies to Snap ring mount Type, MAM Type, MAM-A Type, MAM-B Type)
- Do not exceed the recommended maximum torque when screwing in to the male or female thread of CUPLA for installation. It will cause damage.
- Prior to use, always perform a leak test after installing CUPLA.
- Always install a shut-off valve between the pressure source and CUPLA.
- Do not use with any fluid or medium other than what is specified, to do so could cause leakage or damage.
- The use of inline filters is strongly advised and recommended. To prevent damage, the fluid should be clean before reaching CUPLA.
- Do not use CUPLA in areas or environment where dust such as sand or metal powder can get in to CUPLA. It will lead to malfunction or leakage.
- Do not let paint stick to CUPLA. It will cause malfunction or leakage.
- Be careful not to put scratches or dents on CUPLA. Scratches on the sealing parts will cause leakage.
- Do not apply any artificial impact, bend or tension. It will cause leakage or damage.
- Connecting CUPLA directly to vibrating or impacting equipment will result in reduced lifetime.
- Use only as quick connect couplings for fluid pipelines.
- Only use CUPLA in a combination with NITTO KOHKI coupling "CUPLA".

#### MAM Type

#### Warning

- Do not connect/disconnect with fluid still under dynamic pressure or static residual pressure exceeding the maximum working pressure. It will cause damage to CUPLA.
- Do not drop MULTI CUPLA. It will cause deformation of the plate.

#### Caution

- Do not use CUPLA continuously exceeding the rated working pressure. It will cause leakage or damage.
- Make sure that O-rings and Packing seals are lubricated with grease or oil at all times. If not, the O-rings will get damaged and cause leakage.
- Do not deform the stop ring when installing CUPLA. If the stop ring is widened, it may come off from its groove and lead to poor connection or damage of CUPLA. Also change the stop ring with a new one when replacing CUPLA.
- Install hoses symmetrically from the locking unit when they are connected to CUPLA in order to distribute the reaction force evenly. Failure to do so will lead to breakage.
- Connect after making sure that the lever is in the "connect" position. It will not connect if it is not in the "connect" position.
- Do not force turning the lever. It will cause breakage.
- Do not disassemble CUPLA. It will cause leakage or damage.





## Precautions Relating to the Use of All CUPLA products

Be sure to read the "Instruction Sheet" that comes with the product or "Caution" on the package before use.

### MULTI CUPLA Series

#### MAM-A Type / MAM-B Type

##### Warning

- Do not connect or disconnect CUPLA while they are pressurized or residual pressure of more than 0.6 MPa remains. It will cause damage to CUPLA.
- Do not use CUPLA continuously exceeding the rated working pressure. It will cause leakage or damage.
- Do not drop MULTI CUPLA. It will cause deformation of the plate.

##### Caution

- Make sure that O-rings and Packing seals are lubricated with grease or oil at all times. If not, the O-rings will get damaged and cause leakage.
- Install the C type retaining ring by using a pair of snap ring pliers. If the C type retaining rings are expanded too much, it will come off from its groove and lead to poor connection or breakage. Also change the retaining ring with a new one when replacing CUPLA.
- Install hoses symmetrically from the locking unit when they are connected to CUPLA in order to distribute the reaction force evenly. Failure to do so will lead to breakage.
- Connect after making sure that the lever is in the "connect" position. It will not connect if it is not in the "connect" position.
- Do not force turning the lever. It will cause breakage.
- Do not strike the tip of an automatic shut-off valve with a hammer or a similar tool. It will cause leakage or malfunction.
- Use it in the state that the fluid does not freeze in the case of water. If it freezes, it will cause damage to CUPLA.
- Design and keep the fluid flow speed through CUPLA below 8 m/s. It will cause damage to the valve if used at 8 m/s or over.
- Do not disassemble CUPLA. It will cause leakage or damage.

#### MAS Type / MAT Type

##### Warning

- Do not apply pressure to CUPLA socket or plug while they are disconnected. It will cause leakage or damage.
- Do not use CUPLA continuously exceeding the rated working pressure. It will cause leakage or damage.

##### Caution

- Make sure that O-rings and Packing seals are lubricated with grease or oil at all times. If not, the O-rings will get damaged and cause leakage.
- Keep the center axis eccentricity of the Socket and Plug within 0.6 mm diameter. Failure to do so will lead to leakage or breakage.
- Install the C type retaining ring by using a pair of snap ring pliers. If the C type retaining rings are expanded too much, it will come off from its groove and lead to poor connection or breakage. Also change the retaining ring with a new one when replacing CUPLA. (Applies to MAS Type CUPLA)
- Care must be taken when installing CUPLA not to overtighten or cross thread, this can cause damage and lead to leakage.
- When connecting, connect socket and plug together tightly without a gap. If the gap exceeds 0.5 mm the flow will be reduced.
- For the load required to maintain connection when CUPLA is connected, see the page in this catalog where MAS Type/MAT Type is described. Connection exceeding the maximum acceptable load will cause breakage. Connecting below the minimum load required to maintain connection will result in reduced flow.
- Do not connect/disconnect with fluid still under dynamic pressure or static residual pressure. It will cause damage to the valve.
- Do not strike the tip of an automatic shut-off valve with a hammer or a similar tool. It will cause leakage or malfunction.
- Use it in the state that the fluid does not freeze in the case of water. If it freezes, it will cause damage to CUPLA.
- Design and keep the fluid flow speed through CUPLA below 8 m/s. It will cause damage to the valve if used at 8 m/s or over.
- Do not drop CUPLA. It will cause leakage or malfunction.
- Do not disassemble CUPLA. It will cause leakage or damage.

#### MALC-01 Type

##### Caution

- Do not use CUPLA continuously exceeding the rated working pressure. It will cause leakage or damage.
- Keep the center axis eccentricity of the Socket, Plug and/or hole in the plate within 2 mm diameter. Failure to do so will lead to leakage or breakage. For the dimensions of end configurations for processing on plates, see the page in this catalog where MALC-01 Type is described.
- Oblivity of socket and plug must be within 0.5 degrees during connection or disconnection. If installed exceeding 0.5 degrees, it will cause leakage or damage.
- When connecting, connect socket and plug together tightly without a gap. However, it can be used even when the gap is 0.5 mm. If the gap exceeds 0.5 mm the flow will be reduced.
- For the load required to maintain connection when CUPLA is connected, see the page in this catalog where MALC-01 Type is described. Connection exceeding the maximum acceptable load will cause breakage. Connecting below the minimum load required to maintain connection will result in reduced flow.
- When using water, judge whether CUPLA can be used or not by conducting a performance evaluation test under your actual operating environment and conditions. Leakage may occur according to rust or foreign matter in the piping or solidified minerals. Use it in the state that the fluid does not freeze in the case of water. If it freezes, it will cause damage to CUPLA.
- Design and keep the fluid flow speed through CUPLA below 8 m/s. It will cause damage to the valve if used at 8 m/s or over.
- Do not drop CUPLA. It will cause leakage or malfunction.
- Do not disassemble CUPLA. It will cause leakage or damage.

#### MALC-SP Type / MALC-HSP Type

##### Danger

- Do not use uncoupled socket or plug continuously exceeding its rated working pressure. It will cause leakage or damage. (Applies to MALC Type CUPLA)

##### Warning

- Do not use CUPLA continuously exceeding the rated working pressure. It will cause leakage or damage.
- Do not disassemble CUPLA. It will cause leakage or damage.

##### Caution

- Keep the center axis eccentricity of the Socket and Plug within 2 mm diameter. Failure to do so will lead to leakage or breakage.
- Oblivity of socket and plug must be within 0.5 degrees during connection or disconnection. If installed exceeding 0.5 degrees, it will cause leakage or damage.
- Install the C type retaining ring by using a pair of snap ring pliers. If the C type retaining rings are expanded too much, it will come off from its groove and lead to poor connection or breakage. Also change the retaining ring with a new one when replacing CUPLA. (Applies to Snap ring mount Type)
- Care must be taken when installing CUPLA not to overtighten or cross thread, this can cause damage and lead to leakage. (Applies to MALC-SP Type CUPLA)
- When connecting, connect socket and plug together tightly without a gap. However, it can be used even when the gap is 0.5 mm. If the gap exceeds 0.5 mm the flow will be reduced.
- For the load required to maintain connection when CUPLA is connected, see the page in this catalog where MALC-SP Type or MALC-HSP Type is described. Connection exceeding the maximum acceptable load will cause breakage. Connecting below the minimum load required to maintain connection will result in reduced flow.
- Do not strike the tip of an automatic shut-off valve with a hammer or a similar tool. It will cause leakage or malfunction.
- Use it in the state that the fluid does not freeze in the case of water. If it freezes, it will cause damage to CUPLA.
- Design and keep the fluid flow speed through CUPLA below 8 m/s. It will cause damage to the valve if used at 8 m/s or over.
- Do not drop CUPLA. It will cause leakage or malfunction.

### SEMICON CUPLA Series

##### Warning

- Do not apply pressure to CUPLA socket or plug while they are disconnected. It will cause leakage or damage.
- Prior to use, check the compatibility of the seal material and body material against the temperature and the fluid to be used. Selecting the wrong seal material will lead to leakage. (The "Seal Material Selection Table" and "Body Material Selection Table" described in our product catalog is for reference only.)
- Do not use CUPLA continuously exceeding the rated working pressure. It will cause leakage or damage.
- Only use CUPLA that are within their rated temperature range. Otherwise this can lead to leakage through seal deterioration or damage. It cannot be used continuously at its lowest or highest rated working temperature.
- When using hazardous fluids, always wear protective clothing which are suitable for the fluid being used and will protect the whole body. Any spillage or leakage should be dealt with by an expert in that product.
- Do not connect/disconnect with fluid still under dynamic pressure or static residual pressure. It will cause damage to the valve.
- When using pressure tanks, connect/disconnect as follows:
  - Connection: Connect CUPLA on the nitrogen gas side first, and then reduce the nitrogen gas pressure to ambient pressure. Only after then, connect CUPLA on the liquid side.
  - Disconnection: Reduce the nitrogen gas pressure to ambient pressure, and confirm that the internal pressure has become ambient pressure. Only after then, disconnect CUPLA on the liquid side.
- Do not strike the tip of an automatic shut-off valve with a hammer or a similar tool. It will cause leakage or malfunction. However, if you need to relieve residual pressure, please consult us.

##### Caution

- The durability of CUPLA differs depending on the operating environment and conditions (pressure and temperature etc.). If necessary, conduct performance evaluation test under your actual operating environment and conditions. Also, stress corrosion cracking may occur if used under corrosive environment. Take note of usage conditions. O-rings are consumable items. Replace them periodically.
- If necessary, conduct an elution test and confirm the suitability of the material.
- When cleaning CUPLA, care must be taken not to use any material that will affect the seal and body materials.
- Apply a fluoropolymer resin sealant tape on male tapered pipe threads to ensure no leak.
- Do not exceed the recommended maximum torque when screwing in to the male or female thread of CUPLA for installation. It will cause damage. (Applies to SP Type, SCS Type, SCY Type)

# Safety Guide



## Precautions Relating to the Use of All CUPLA products

Be sure to read the "Instruction Sheet" that comes with the product or "Caution" on the package before use.

### SEMICON CUPLA Series

#### Caution

- Care must be taken when installing CUPLA not to overtighten or cross thread, this can cause damage and lead to leakage. (Applies to SP Type, SCS Type, SCY Type)
- When installing SCT Type or SCAL Type CUPLA, firstly apply a fluoropolymer resin sealant tape on the male tapered pipe thread and tighten firmly by hand. Then, additionally tighten with a wrench by turning it 1 3/4 to 2 turns. At this time, overtightening will damage the thread and cause leakage, so be careful.
- Do not use anything other than the applicable tube sizes. It will cause leakage.
- Contact us if detail dimensions of the fixing part is required, such as 19/32-18UNS (for SP Type or SCS Type) or application shape for plugs of SCF Type CUPLA.
- Prior to use, always perform a leak test after installing CUPLA.
- For the purpose of reducing the insertion load on connection and to prevent O-ring from damage, apply pure water or a lubricant that is suitable for the operational environment to the Plug tip and sealing surface. (Applies to SP Type, SCS Type)
- After connection, try to pull the socket and plug apart to confirm secure connection. If the connection is incomplete, the socket and plug may disconnect when pressurized.
- For fluoropolymer resin CUPLA, continuous use under dynamic pressure will result in reduced performance. To extend lifetime, it is recommended to be kept unpressurized unless it is necessary.
- Since the bellows of the SCAL Type CUPLA Socket is made of polytetrafluoroethylene (PTFE), a small amount of gas will escape.
- When using for hazardous fluids, discharge all the fluid inside CUPLA with nitrogen gas, etc., before disconnecting. If disconnected without discharging the fluid, a small amount of fluid will spill out.
- Always mount a designated dust cap after disconnection. Any foreign matter adhering to the sealing surface will cause leakage.
- Always install a shut-off valve between the pressure source and CUPLA.
- The use of inline filters is strongly advised and recommended. To prevent damage, the fluid should be clean before reaching CUPLA.
- Design and keep the fluid flow speed through CUPLA below 8 m/s. It will cause damage to the valve if used at 8 m/s or over.
- Do not use CUPLA in areas or environment where dust such as sand or metal powder can get in to CUPLA. It will lead to malfunction or leakage.
- Do not let paint stick to CUPLA. It will cause malfunction or leakage.
- Be careful not to put scratches or dents on CUPLA. Scratches on the sealing parts will cause leakage. Especially, CUPLA made of fluoropolymer resin are deformed easily, so be careful.
- Do not apply any artificial impact, bend or tension. It will cause leakage or damage.
- Do not drop CUPLA. It will cause leakage or malfunction.
- Connecting CUPLA directly to vibrating or impacting equipment will result in reduced lifetime.
- Use only as quick connect couplings for fluid pipelines. (It cannot be used as a swivel joint)
- Do not disassemble CUPLA. It will cause leakage or damage.
- Check CUPLA regularly. Stop using immediately if anything unusual is found on CUPLA.

### CUPLA for Inert Gas

#### Warning

- Do not apply pressure to CUPLA socket or plug while they are disconnected. It will cause leakage or damage. (Applies to SP-V CUPLA TypeA)
- Do not use CUPLA continuously exceeding the rated working pressure. It will cause leakage or damage.
- The fluid in the piping will spill out upon disconnection. Take extra care when using at places where it is liable to cause anoxia. (Applies to PCV PIPE CUPLA)

#### Caution

- Prior to use, check the compatibility of the seal material and body material against the temperature and the fluid to be used. Selecting the wrong seal material will lead to leakage.
- Only use CUPLA that are within their rated temperature range. Otherwise this can lead to leakage through seal deterioration or damage. It cannot be used continuously at its lowest or highest rated working temperature.
- The durability of CUPLA differs depending on the operating environment and conditions (pressure and temperature etc.). If necessary, conduct performance evaluation test under your actual operating environment and conditions. Also, stress corrosion cracking may occur if used under corrosive environment. Take note of usage conditions. Please replace PCV PIPE CUPLA at approximately 5000 times connections/disconnections. (It differs depending on the operating environment and conditions)
- When cleaning CUPLA, care must be taken not to use any material that will affect the seal and body materials.
- Apply thread sealants on male tapered pipe threads to ensure no leak.
- Do not exceed the recommended maximum torque when screwing in to the male or female thread of CUPLA for installation. It will cause damage.
- Care must be taken when installing CUPLA not to overtighten or cross thread, this can cause damage and lead to leakage. (Applies to SP-V CUPLA TypeA Body material: Stainless steel)
- Prior to use, always perform a leak test after installing CUPLA.
- Make sure that O-rings are lubricated with grease at all times. If not, the O-rings will get damaged and cause leakage. (Applies to SP-V CUPLA TypeA seal materials: CR, FKM)
- For the purpose of reducing the insertion load on connection and to prevent O-ring from damage, apply a lubricant that is suitable for the operational environment to the Plug tip and sealing surface. (Applies to SP-V CUPLA TypeA Seal material: HNBR)
- Do not use pipe sizes other than the suitable sizes. It will cause leakage. Contact us if required to use Aluminum alloy pipes. (Applies to PCV PIPE CUPLA)
- Chamfer the edge of the copper pipe to be used. If not chamfered, it will damage the packing and cause leakage. Do not use pipes with deformation or burrs. It will lead to leakage or poor connection. (Applies to PCV PIPE CUPLA)
- When connecting copper pipes, push down the lever only after confirming that the end of the copper pipe is pressed against the packing inside CUPLA. At this time, be careful not to get fingers caught. (Applies to PCV PIPE CUPLA)
- After connection, try to pull the socket and plug apart or CUPLA and pipe apart to confirm secure connection. If the connection is incomplete, the socket and plug or CUPLA and pipe may disconnect when pressurized.
- Do not disconnect with fluid still under dynamic pressure or static residual pressure. (Applies to PCV PIPE CUPLA)
- Contact us if it is required to connect/disconnect SP-V CUPLA TypeA under dynamic pressure or static residual pressure.
- When connected with the copper pipe, do not rotate the pipe. It will damage the packing and cause leakage. (Applies to PCV PIPE CUPLA)
- Put a designated dust cap on CUPLA after disconnection when there is a possibility of foreign matter such as dirt sticking to the seal surface. (Applies to SP-V CUPLA TypeA)
- When disconnected, store CUPLA with the lever in the "Open" position. (Applies to PCV PIPE CUPLA)
- Always install a shut-off valve between the pressure source and CUPLA.
- Do not strike the tip of an automatic shut-off valve with a hammer or a similar tool. It will cause leakage or malfunction. (Applies to SP-V CUPLA TypeA) However, if you need to relieve residual pressure, please consult us.
- Do not use with any fluid or medium other than what is specified, to do so could cause leakage or damage.
- The use of inline filters is strongly advised and recommended. To prevent damage, the fluid should be clean before reaching CUPLA.
- Do not use CUPLA in areas or environment where dust such as sand or metal powder can get in to CUPLA. It will lead to malfunction or leakage.
- Do not let paint stick to CUPLA. It will cause malfunction or leakage.
- Be careful not to put scratches or dents on CUPLA. Especially, scratches on the sealing parts will cause leakage.
- Do not apply any artificial impact, bend or tension. It will cause leakage or damage.
- Do not drop CUPLA. It will cause leakage or malfunction.
- Connecting CUPLA directly to vibrating or impacting equipment will result in reduced lifetime.
- Stop using CUPLA if the lever is deformed. (Applies to PCV PIPE CUPLA)
- Ensure that any copper residue or swarf that has adhered to the inside of CUPLA is removed after use. (Applies to PCV PIPE CUPLA)
- Use only as quick connect couplings for fluid pipelines. (It cannot be used as a swivel joint) (Applies to SP-V CUPLA TypeA)
- Only use CUPLA in a combination with NITTO KOHKI coupling "CUPLA". (Applies to SP-V CUPLA TypeA)
- Do not disassemble CUPLA. It will cause leakage or damage.

### PAINT CUPLA

#### Warning

- Make sure that a hose containing a ground wire is connected to a ground. Insufficient grounding will lead to fire or dangerous explosion caused by possible sparks of static electricity.
- Wear appropriate clothes and protective equipment such as safety glasses, face guard and gloves at all times. Otherwise it could be potentially hazardous when paint or solvent splashes on to operators.

#### Caution

- This CUPLA is designed for paints diluted by solvents. Do not use this CUPLA for any other applications such as Powder coating, Electrostatic coating or Electrodeposition coating. The seal material will deteriorate and cause leakage. As to the use of any special paint or solvent, make thoroughly sure of the material compatibility.
- Do not use CUPLA continuously exceeding the rated working pressure. It will cause leakage or damage.
- Only use CUPLA that are within their rated temperature range. Otherwise this can lead to leakage through seal deterioration or damage. It cannot be used continuously at its lowest or highest rated working temperature.
- The durability of CUPLA differs depending on the operating environment and conditions (pressure and temperature etc.). If necessary, conduct performance evaluation test under your actual operating environment and conditions. Also, stress corrosion cracking may occur if used under corrosive environment. Take note of usage conditions.
- Do not exceed the recommended maximum torque when screwing in to the male or female thread of CUPLA for installation. It will cause damage.
- Prior to use, always perform a leak test after installing CUPLA.
- After connection, try to pull the socket and plug apart to confirm secure connection. If the connection is incomplete, the socket and plug may disconnect when pressurized.
- The fluid in the piping of the plug side will spill out upon disconnection. Be careful so that it will not contact the human body.
- Clean CUPLA each time after use. Otherwise paint will dry out and will cause malfunction, insufficient color mix or poor grounding. When cleaning CUPLA, care must be taken not to use any material that will affect the seal and body materials.
- When cleaning, do not try to open the valve by inserting something except the plug into the socket. It will cause leakage.
- Always install a shut-off valve between the pressure source and CUPLA.
- The use of inline filters is strongly advised and recommended. To prevent damage, the fluid should be clean before reaching CUPLA.
- Always let fluid flow from socket to plug.
- Do not use CUPLA in areas or environment where dust such as sand or metal powder can get in to CUPLA. It will lead to malfunction or leakage.
- Be careful not to put scratches or dents on CUPLA. Especially, scratches on the sealing parts will cause leakage.
- Do not apply any artificial impact, bend or tension. It will cause leakage or damage.
- Do not drop CUPLA. It will cause leakage or malfunction.
- Connecting CUPLA directly to vibrating or impacting equipment will result in reduced lifetime.
- Use only as quick connect couplings for fluid pipelines. (It cannot be used as a swivel joint)
- Only use CUPLA in a combination with NITTO KOHKI coupling "CUPLA".
- Do not disassemble CUPLA. It will cause leakage or damage.

## ⚠️ Precautions Relating to the Use of All CUPLA products

Be sure to read the "Instruction Sheet" that comes with the product or "Caution" on the package before use.

### HYGIENIC CUPLA

#### ⚠️ Warning

Any residual fluid remaining in the passage will spill out on disconnection. Drain any residual fluid before disconnection to avoid burns or injury to the skin when dangerous fluid such as chemical agent or high temperature fluid is used. If the fluid comes into contact with the skin, stop the disconnecting work and consult a doctor if necessary.

#### ⚠️ Caution

Observe the cautions below. If not observed, it could result in burns, injury to the skin, damage to the product or other machinery when dangerous fluid such as chemical agent or high temperature fluid is used. Stop using CUPLA immediately if this happens.

- CUPLA can be easily disassembled for cleaning. CUPLA should be evaluated before use to determine the suitability with regard to sanitation and safety. Especially when using O-rings of other brands than Nitto Kohki, be sure to evaluate the O-ring at your end.
- Prior to use, check the compatibility of the seal material and body material against the temperature and the fluid to be used. Selecting the wrong seal material will lead to leakage.
- Do not use CUPLA continuously under any pressure exceeding the rated working pressure. This may cause leakage or damage.
- Use only within range of its rated temperature. May cause damage or deterioration to the sealing and leak if used otherwise.
- Also, do not use continuously at the lowest or highest working temperature.
- The durability of CUPLA differs depending on the operating environment and conditions (pressure and temperature etc.).
- If necessary, conduct performance evaluation test under your actual operating environment and conditions.
- When assembling, disassembling and washing, do not drop the disassembled parts, or put scratches on the sealing surface. It will cause malfunction or leakage.
- When washing, do not deform the lock plate by applying excessive force. It will cause bad connection.
- When assembling or disassembling, do not put scratches on the O-ring. Also do not attach the O-ring in a twisted state. It will cause leakage.
- When welding to CUPLA, do so with CUPLA in disassembled state. Welding in assembled state will deform the parts or damage the O-ring and cause leakage.
- The outer diameter and thickness of the pipe to be welded to CUPLA must conform to JIS G 3447.
- After welding to CUPLA, please polish the welded part. (Surface roughness Ra  $\leq$  1.0  $\mu$ m recommended for the liquid contact parts. Surface roughness on the weld line should not exceed Ry=16  $\mu$ m.)
- If it is not polished or if the surface roughness becomes rougher than the recommended value, it may potentially cause the spread of bacteria.
- Malfunction caused by welding (directly or otherwise) is not included in the warranty.
- For the ferrule type, please use ferrule couplings conforming to IDF/ISO 2852.
- Prior to use, always perform a leak test after installing CUPLA.
- When a high temperature fluid is applied to CUPLA, be careful in handling CUPLA as it also becomes hot. If CUPLA is used in a high temperature atmosphere, the cam handle may not rotate smoothly. In such case, please apply water, etc. to the part where the cam handle and the lock plate ASSY is in contact.
- When powder is applied to CUPLA, static electricity may be generated. Please take countermeasure against this if required.
- When CUPLA remains connected for long periods of time, it may become difficult to disassemble. In this case, do not forcefully turn the socket and plug to disconnect as this may damage the seal material and cause leakage.
- Do not disconnect with fluid still under dynamic pressure or static residual pressure.
- Do not drop CUPLA. It will cause leakage or malfunction.
- Always install a shut-off valve between the pressure source and CUPLA.
- Do not apply any artificial impact, bend or tension. It will cause leakage or damage.
- Connecting CUPLA directly to vibrating or impacting equipment will result in reduced lifetime.
- Use only as quick connect couplings for fluid pipelines.
- Only use CUPLA in a combination with NITTO KOHKI coupling "CUPLA".
- Check CUPLA regularly. Stop using immediately if anything unusual is found on CUPLA.
- When storing CUPLA, remove the O-ring from the plug. Otherwise, it may become difficult to remove due to adsorption.
- Before using CUPLA, disassemble and clean it in the way that is appropriate to your usage conditions and not affecting the seal material and body material.



#### Seal part (cross section)

Because of the structure of this product, dead space is generated when using.

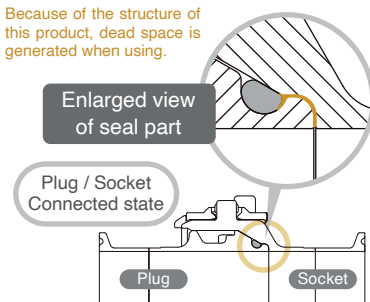

- The O-ring and Lock plate ASSY are consumable items.
- Please replace the Lock plate ASSY at approximately 1,000 times connections/disconnections.
- When the Lock plate ASSY is deformed, replace it with a new one regardless of connection/disconnection times.
- The durability of the O-ring differs depending on the operating environment and conditions (pressure and temperature etc.).

### SEMI-STANDARD CUPLA Series

Contact us separately for detail cautions for the SEMI-STANDARD CUPLA series.

## Maintenance of CUPLA

### O-ring Replacement Procedure

The internal O-ring is a consumable item. If the O-ring in the socket has failure such as wear and tear or deterioration, take the following steps to replace it with a new one. Always use genuine Nitto Kohki O-rings.

#### Accessories for O-ring maintenance

##### Grease for O-ring

5 mL container



##### O-ring replacement Jig

PMJ-1 (Small)

PMJ-2 (Large)



- GRE-M1 (Mineral grease) for NBR and FKM
- GRE-HC1 (Hydrocarbon grease) for NBR and FKM
- GRE-S1 (Silicone grease) for NBR, FKM, and EPDM
- GRE-S2 (Silicone grease) for NBR, FKM, and EPDM (NSF H1, NSF 61 registered product)
- GRE-S3 (Silicone grease) for NBR, FKM, and EPDM

#### ⚠️ Caution for Storing CUPLA

- Store CUPLA in a place where no dust or foreign matter gets in. If fluid flows while the dust or foreign matter is present inside CUPLA, the dust or foreign matter may go into the equipment connected to CUPLA and may cause malfunction.
- Store CUPLA indoors away from water or moisture.
- Store CUPLA in a shaded, dry and well-ventilated place.
- Do not to drop CUPLA. It will deform or damage CUPLA.
- If CUPLA is stored or not being used for a long period of time, check their appearance, function and performance before use.

CUPLA should be inspected periodically to ensure safe operation and to prevent them from a performance drop or malfunction. If there is a malfunction in CUPLA or wear and tear, please replace it with a new one. If you have any concerns, contact Nitto Kohki or the distributor from whom you purchased your CUPLA.

#### How to Remove the O-ring

- 1 Use an optional O-ring replacement Jig to remove the O-ring. Be careful not to damage the groove of O-ring with the jig. Used O-rings with wear and tear or deterioration can be removed easily with the jig.
- 2 After removing the O-ring, wipe the groove clean with a cloth.

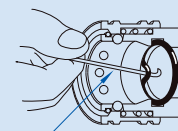

O-ring replacement Jig

#### How to Install a New O-ring

- 1 After making sure that no dust or foreign matter exists in the groove of O-ring, push in part of the O-ring and the remaining part can be easily pressed in with the jig.
- 2 HSP CUPLA has a backup ring. Insert an O-ring in the place as shown in the figure. If CUPLA connection/disconnection is hard and not smooth after the O-ring has been replaced, apply a little grease to the O-ring.

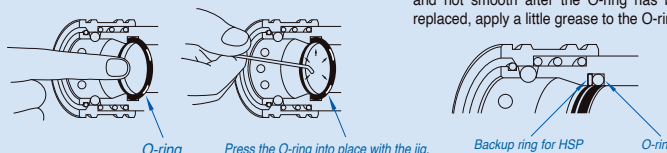



## Quick Connect Couplings

The logo for CUPLA is registered trademark or a trademark of Nitto Kohki Co., Ltd. in Japan, the United States and/or certain other countries.

 <b>Japanese</b> <a href="http://www.nitto-kohki.co.jp/network/jp/">www.nitto-kohki.co.jp/network/jp/</a>	 <b>Vietnamese</b> <a href="http://www.nitto-kohki.co.jp/network/vi/">www.nitto-kohki.co.jp/network/vi/</a>
 <b>English</b> <a href="http://www.nitto-kohki.co.jp/network/">www.nitto-kohki.co.jp/network/</a>	 <b>Indonesian</b> <a href="http://www.nitto-kohki.co.jp/network/id/">www.nitto-kohki.co.jp/network/id/</a>
 <b>Thai</b> <a href="http://www.nitto-kohki.co.jp/network/th/">www.nitto-kohki.co.jp/network/th/</a>	 <b>Spanish</b> <a href="http://www.nitto-kohki.co.jp/network/es/">www.nitto-kohki.co.jp/network/es/</a>
 <b>YouTube</b> <a href="http://www.youtube.com/c/NittoKohkiGLOBAL">www.youtube.com/c/NittoKohkiGLOBAL</a>	 <b>eCatalog</b> <a href="http://www.nitto-kohki.co.jp/e/prd/d_cat/">www.nitto-kohki.co.jp/e/prd/d_cat/</a>

# NITTO KOHKI CO., LTD.

## Head Office

2-9-4, Nakaikegami, Ota-ku, Tokyo 146-8555, Japan

Tel : +81-3-3755-1111 Fax : +81-3-3753-8791 E-mail : [overseas@nitto-kohki.co.jp](mailto:overseas@nitto-kohki.co.jp)

**Web** [www.nitto-kohki.co.jp/e/](http://www.nitto-kohki.co.jp/e/)



## Overseas Affiliates / Offices

### NITTO KOHKI U.S.A., INC.

46 Chancellor Drive, Roselle, Illinois 60172, U.S.A.

For CUPLA

Tel : +1-630-924-5959 Fax : +1-630-924-1174

For Tool

Tel : +1-630-924-9393 Fax : +1-630-924-0303

For Pump

Tel : +1-630-924-8811 Fax : +1-630-924-0808

[www.nittokohki.com/](http://www.nittokohki.com/)

### NITTO KOHKI EUROPE GMBH

Gottlieb-Daimler-Str. 10, 71144 Steinenbronn, Germany

Tel : +49-7157-989555-0 Fax : +49-7157-989555-40

[www.nitto-kohki.eu/](http://www.nitto-kohki.eu/)

### NITTO KOHKI EUROPE GMBH UK Branch

Unit A5, Langham Park Industrial Estate, Maple Road, Castle Donington, Derbyshire DE74 2UT, United Kingdom

Tel : +44-1332-653800 Fax : +44-1332-987273

[www.nitto-kohki.eu/](http://www.nitto-kohki.eu/)

### NITTO KOHKI CO., LTD. Bangkok Representative Office

2 Jasmine Building, 22nd Floor, Soi Prasarnmitr(Sukhumvit23), Sukhumvit Road, North Klontoe, Wattana, Bangkok 10110, Thailand

Tel : +66-2612-7388

Thai [www.nitto-kohki.co.jp/network/th/](http://www.nitto-kohki.co.jp/network/th/)

Vietnamese [www.nitto-kohki.co.jp/network/vi/](http://www.nitto-kohki.co.jp/network/vi/)

### NITTO KOHKI CO., LTD. India Liaison Office

14th Floor, Tower 5B, DLF Eptome, DLF Cyber City, Phase 3, Gurugram, Haryana 122002, India

Tel : +91-124-460-7701

[www.nitto-kohki.co.jp/network/](http://www.nitto-kohki.co.jp/network/)

### NITTO KOHKI CO., LTD. Singapore Branch

18, Kaki Bukit Road 3, #02-12, Entrepreneur Business Centre, Singapore 415978

Tel : +65-6227-5360 Fax : +65-6227-0192

[www.nitto-kohki.co.jp/network/](http://www.nitto-kohki.co.jp/network/)

### NITTO KOHKI CO., LTD. Indonesia Representative Office

Plaza Marein 23rd Floor Jl. Jend. Sudirman Kav. 76-78, Jakarta 12910, Indonesia

Tel : +62-21-8065-7808

[www.nitto-kohki.co.jp/network/id/](http://www.nitto-kohki.co.jp/network/id/)

### NITTO KOHKI AUSTRALIA PTY LTD

77 Brandl Street, Eight Mile Plains, Queensland 4113, Australia

Tel : +61-7-3340-4600 Fax : +61-73340-4640

[www.nitto-australia.com.au/](http://www.nitto-australia.com.au/)

### NITTO KOHKI (SHANGHAI) CO., LTD.

Room 2602, Shanghai International Trade Center, No.2201 Yan An West Road, Shanghai 200336, China

Tel : +86-21-6415-3935 Fax : +86-21-6472-6957

[www.nitto-kohki.cn/](http://www.nitto-kohki.cn/)

### NITTO KOHKI (SHANGHAI) CO., LTD. Shenzhen Branch

Room 708, Building 1, Wanting Building, No. 2009 Baoyuan Road, Baoan District, Shenzhen, Guangdong 518102, China

Tel : +86-755-8375-2185 Fax : +86-755-8375-2187

[www.nitto-kohki.cn/](http://www.nitto-kohki.cn/)

## DISTRIBUTED BY